

VEROBOARD®

LED Type: VBDFS-5050-RGB-30-12-WP
Colour: RGB

Contact Name: _____

Company: _____

Phone: _____

Email: _____



DESCRIPTION

Flexible 14mm wide linear LED strip. Available in 10 meter (32.8 feet) rolls that can be cut every 3 LEDs (101.6mm or 4in). The LED Strip lights are manufactured with high-quality materials and designed for professional lighting. Every strip light begins with a heavy-duty dual-core copper printed circuit board (PC board), it is then soldered with an array of chips and color options. They can be cut to any size (marked interval points) and rejoined by soldering. Moreover, the ingress protection rating of IP68 helps in adopting any weather condition (indoor/outdoor) applications.



	Wattage
Per Foot	2.2W/ft
Per Meter	7.2W/m

666561409760

DIMENSIONS

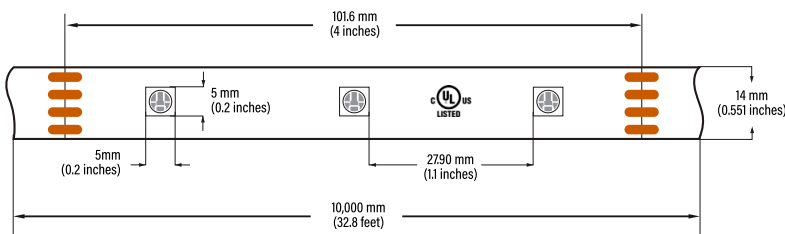

SPECIFICATIONS

Model:	VBDFS-5050-RGB-30-12-WP
Color Temperature:	RGB
LED Type:	5050 SMD
LED Qty:	30 LEDs per meter
Input Voltage (VF):	12V DC
Power:	7.2W per meter (2.2W/ft)
Brightness:	1600-2200 MCD
Lifespan:	>50,000 hours
PCB:	4oz PCB, Double-side, white colour 12mm width
IP Rating:	IP68 (Outdoor rated)
Rendering Index (Ra):	CRI>95
Beam Angle:	120°
Dimmable:	Yes
Cut Size:	Every 3 LED chips (4")
Operating Temperature:	-15°C to +40°C
Dimensions:	10,000 x 14 x 5.8mm (393.6" x 0.551" x 0.22")
Certificates:	UL / RoHs
Roll Length:	10 meter roll (32.8ft)



IP68

Waterproof



Accessories (Sold Separately)

Model: 3W-2C-SC-RGB
SKU: 666561417345

Model: 3W-YC-RGB-M684
SKU: 666561434199

Model: 3W-JB-M686
SKU: 666561434182

**3 Way Outdoor
 Screw Type Connector
 4 Contact (RGB)**

**3 Way Outdoor
 Screw Type Connector
 4 Contact (RGB)**



ORDERING GUIDE

Example part number: **VBDFS - 5050 - RGB - 30 - 12 - WP**

MODEL	SERIES	COLOUR	LEDS/METER	VOLTAGE	LENGTH
VBDFS	5050	RGB	30	12V	XXXX

Custom Length
 WP (Full Roll
 10 Meter)

For more information about our products and services, please visit our website: www.veroboard.com

CONTROLLERS (Sold Separately)



Model: SR-2819S (R3)

SKU: 666561430863

Compatible Receivers:

- | | | |
|---------------------------|----------|--------------------------|
| • SR-1009EA-5C (R-25.5A) | 300-900W | SKU: 666561430818 |
| • SR-1009TYWi-5C (R-4A) | 300-900W | SKU: 666561430788 |
| • SR-1009EATYWi-5C (R-8A) | 96-192W | SKU: 666561430795 |

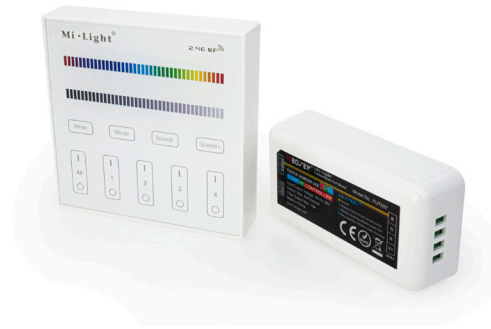

Model: VBD-MI-4Z-B3

SKU: 666561412913

Compatible Receivers:

- | | |
|-----------------|--------------------------|
| • VBD-MI-FUT037 | SKU: 666561412869 |
| • VBD-MI-FUT038 | SKU: 666561425180 |

To see all available controllers and remote controls, please scan the QR code with your smartphone.

Disclaimer:

The data and information contained in this specification sheet are subject to change without notice; the ratings supplied are provided based on the product manufacturer. The information contained in this specification sheet should not be considered a warranty, expressed or implied, including, but not limited to, a warranty of merchantability or fitness for a particular purpose. In no event shall Veroboard be liable for any incidental or consequential damages resulting from the use, misuse, or inability to use the product. This exclusion applies regardless of whether such damages are sought based on breach of warranty, breach of contract, negligence, strict liability in tort, or any other legal theory.



Light Measurement Report

Print date: 2023-04-25

Measurement date and time: 2023-04-25 2:51:59 PM – Measurement no. VFR-230425-0169-MS

Luminous Intensity diagram

Unit: 0-100% of peak intensity

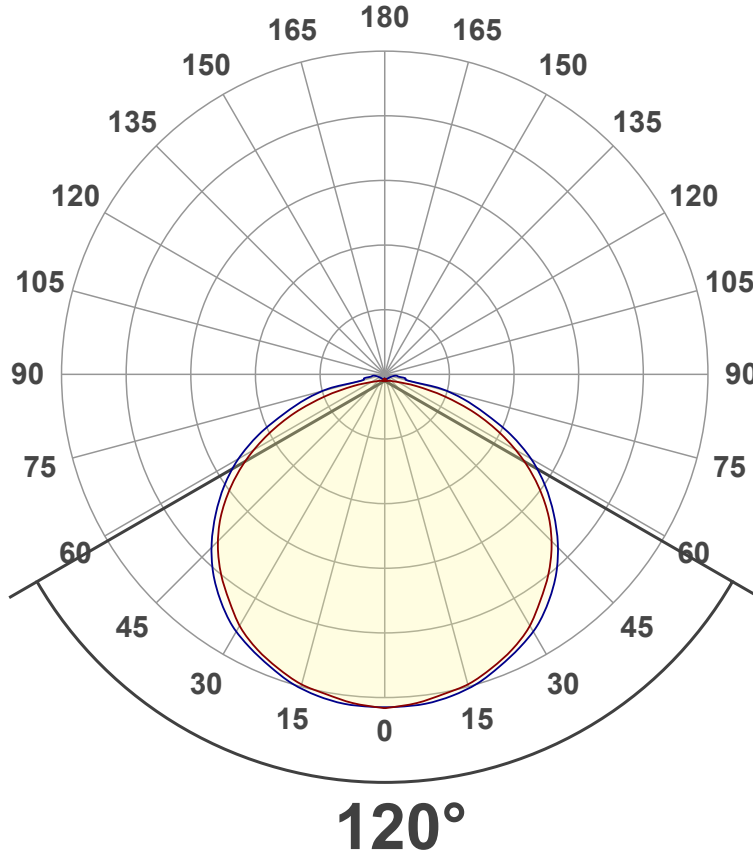

Main Values

Lumen Up% / Down%	3.16% / 96.84%
Peak Intensity	12.6 cd
Beam Angle (50%)	120°
Beam Angle (90%)	126.4°
Beam Angle (10%)	120.8°

Cut-off Angle

Average 2,5%	209.6°
--------------	--------

Field Angle

Average 10%	167.7°
-------------	--------

Intensity Ratio

In 120° cone	73.1%
In 90° cone	48.2%

C000-C180
C090-C270

Linear distribution diagram - Intensity (candela) vs γ -angle

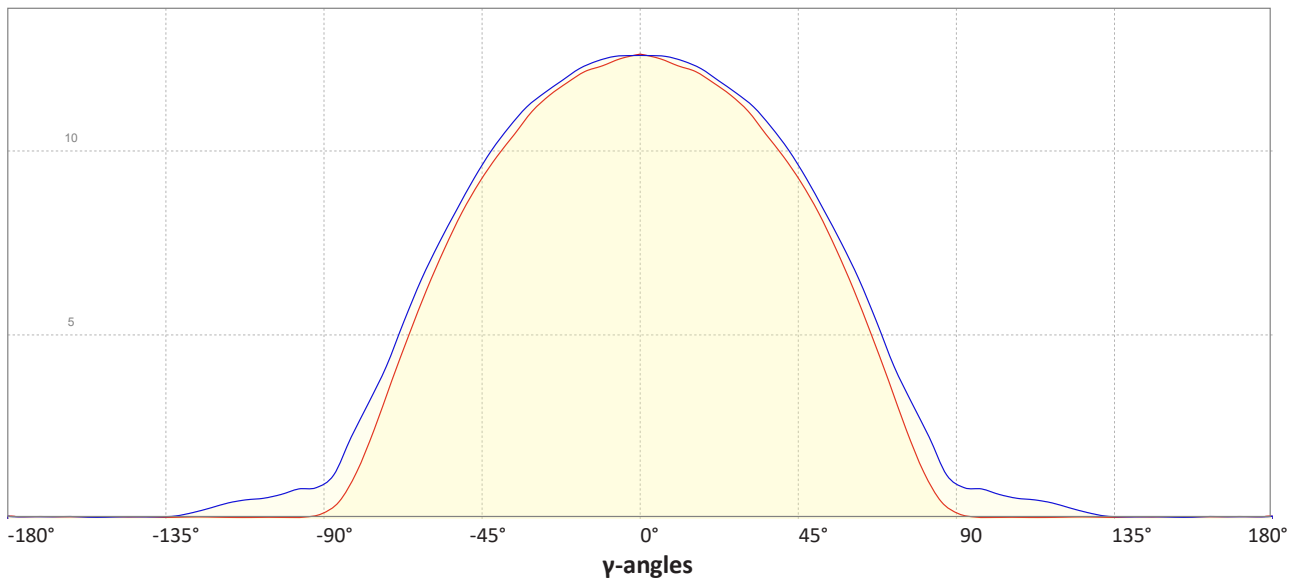

Light Measurement Report

Print date: 2023-04-25

Measurement date and time: 2023-04-25 2:51:59 PM – Measurement no. VFR-230425-0169-MS

Beam Details

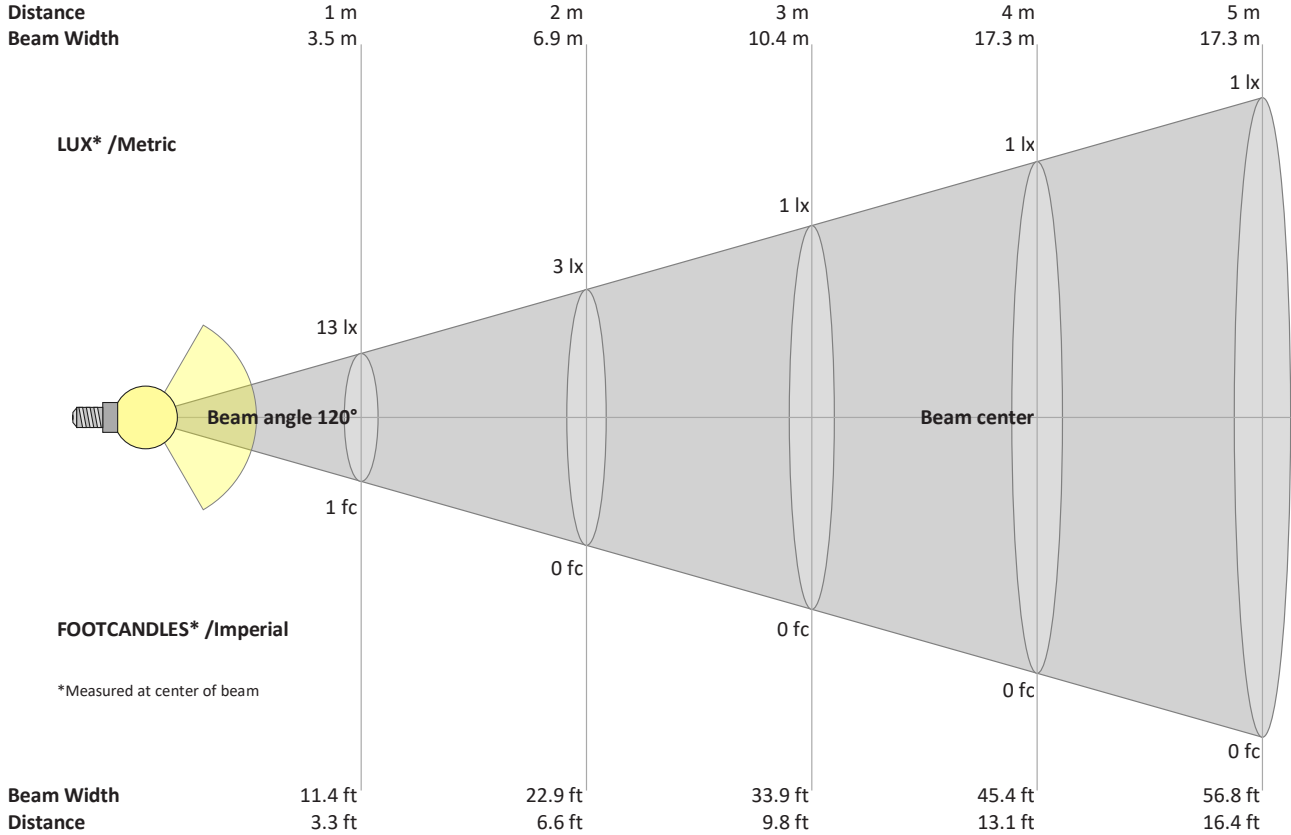

Beam intensities from 1 – 20 m

1	2	3	4	5	6	7	8	9	10	11	12	13	14	15	16	17	18	19	20	m	
3.3	6.6	9.8	13.1	16.4	19.7	23	26.2	29.5	32.8	36.1	39.4	42.7	45.9	49.2	52.5	55.8	59.1	62.3	65.6	ft	
13	3	1	1	1	0	0	0	0	0	0	0	0	0	0	0	0	0	0	0	0	lux
1.2	0.3	0.1	0.1	0	0	0	0	0	0	0	0	0	0	0	0	0	0	0	0	0	fc

Intensities in 0° c-plane

0°	5°	10°	15°	20°	25°	30°	35°	40°	45°	50°	55°	60°	65°	70°	75°	80°	85°	90°	95°	y
12.6	12.5	12.3	12.2	11.9	11.6	11.1	10.6	9.9	9.3	8.4	7.5	6.4	5.2	3.9	2.6	1.4	0.6	0.2	0.1	cd
100%	99%	98%	97%	94%	92%	88%	84%	79%	73%	67%	59%	51%	41%	31%	21%	11%	5%	1%	0%	of 0°val

Intensities in 90° c-plane

0°	5°	10°	15°	20°	25°	30°	35°	40°	45°	50°	55°	60°	65°	70°	75°	80°	85°	90°	95°	y
12.6	12.6	12.5	12.3	12.1	11.7	11.4	10.9	10.3	9.6	8.8	7.9	7.0	5.9	4.7	3.6	2.6	1.7	1.0	0.8	cd
100%	100%	99%	98%	96%	93%	90%	86%	82%	76%	70%	63%	55%	47%	37%	29%	21%	13%	8%	7%	of 0°val

Intensities in 180° c-plane

0°	5°	10°	15°	20°	25°	30°	35°	40°	45°	50°	55°	60°	65°	70°	75°	80°	85°	90°	95°	y
12.6	12.5	12.3	12.2	11.9	11.6	11.1	10.6	9.9	9.3	8.4	7.5	6.4	5.2	3.9	2.6	1.4	0.6	0.2	0.1	cd
100%	99%	98%	97%	94%	92%	88%	84%	79%	73%	67%	59%	51%	41%	31%	21%	11%	5%	1%	0%	of 0°val

Intensities in 270° c-plane

0°	5°	10°	15°	20°	25°	30°	35°	40°	45°	50°	55°	60°	65°	70°	75°	80°	85°	90°	95°	y
12.6	12.6	12.5	12.3	12.1	11.7	11.4	10.9	10.3	9.6	8.8	7.9	7.0	5.9	4.7	3.6	2.6	1.7	1.0	0.8	cd
100%	100%	99%	98%	96%	93%	90%	86%	82%	76%	70%	63%	55%	47%	37%	29%	21%	13%	8%	7%	of 0°val

CUSTOM ORDERING GUIDE

Single Run (Straight Run): The below ordering guide will be used for single run LED strip.

- **PFL:** Power Feed Length
- **SL:** Strip Length



Example: 2 (QTY) x 36" (PFL) - 84" (SL) x -

CUSTOM ORDERING GUIDE

Joiner: LED strip lights need joiners if they are used for curve applications such as corner side, behind a mirror, etc.

- **PFL:** Power Feed Length
- **SL:** Strip Length
- **JL:** Joiner Length

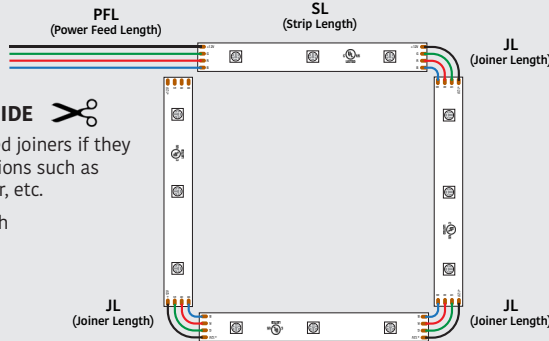

x - - - - - - -

Example: 1 (QTY) x 12" (PFL) - 46" (SL) - 1" (JL) - 36" (SL) - 1" (JL) - 46" (SL) - 1" (JL) - 36" (SL)

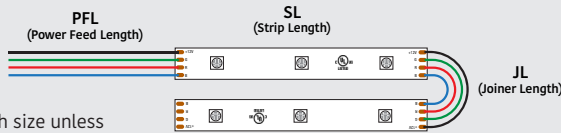

Note: Joiners will be 1-inch size unless customers require a specific size.

x - - -

Example: 2 (QTY) x 24" (PFL) - 52" (SL) - 1" (JL) - 52" (SL)

RECOMMENDED LED ALUMINUM CHANNELS

(Sold Separately)

VBD-CH-S6 SKU: 666561423315	VBD-CH-C2 SKU: 666561423506	VBD-CH-C2B SKU: 666561423513		
VBD-CH-RF4 SKU: 666561423377	VBD-CH-C1 SKU: 666561423490	VBD-CH-C3 SKU: 666561423520		
VBD-CH-C3B SKU: 666561423537	VBD-CH-C4 SKU: 666561423544	VBD-CH-C4B SKU: 666561423551		
VBD-CH-WC1 SKU: 666561423599	VBD-CH-RF3 SKU: 666561423360	VBD-CH-RF5 SKU: 666561423384		
VBD-CH-R2 SKU: 666561423742	VBD-CH-R2B SKU: 666561428280	VBD-CH-WC2 SKU: 666561423605		
VBD-CH-WC3 SKU: 666561423612	VBD-CH-WC4 SKU: 666561423629	VBD-CH-RF6 SKU: 666561423391	VBD-CH-RF7 SKU: 666561423407	
VBD-CH-RF8 SKU: 666561423414	VBD-CH-S1 SKU: 666561423247	VBD-CH-R1 SKU: 666561423735	VBD-CH-R3 SKU: 666561423759	VBD-CH-RF10 SKU: 666561423438

For more information about our products and services, please visit our website: www.veroboard.com

VBD-CH-D1	VBD-CH-D5	VBD-CH-D8	VBD-CH-D9
SKU: 666561423643	SKU: 666561423681	SKU: 666561423711	SKU: 666561423728

Note: To avoid a dark spot on the sides of these channels (RF10, RF6, RF8, R3, S1, R3) we recommend installing more than one Run LED Strip. For more details please contact us at: sales@veroboard.com

RECOMMENDED LED POWER SUPPLIES (Sold Separately)

For more options and varieties, please visit our website: www.veroboard.com

Constant Voltage Dimmable LED Drivers (5 in 1), Triac/Phase, 0-10V, 1-10V, Potentiometer, 10V PWM 5 in 1 Dimming



Model No.	Input Voltage	Output Voltage	Wattage	IP Rating	Class	Max. Strip Length	SKU#
VBD-012-030C2DM5i1	100-277V	12V	30W	IP67	Class 2	17ft	666561425999
VBD-012-060C2DM5i1	100-277V	12V	60W	IP67	Class 2	21.8ft	666561426002
VBD-012-100C2DM5i1	100-277V	12V	100W	IP65	Type HL	36.3ft	666561428426
VBD-012-150C2DM5i1	100-277V	12V	150W	IP65	Type HL	54.5ft	666561428433
VBD-012-180C2DM5i1	100-277V	12V	180W (3x60W)	IP67	Class 2	65.4ft	666561426019
VBD-012-300C2DM5i1	100-277V	12V	300W (5x60W)	IP67	Class 2	109ft	666561426026

Constant Voltage Triac LED Drivers forward Phase, Magnetic Low Voltage & Triac Dimmers



Model No.	Input Voltage	Output Voltage	Wattage	IP Rating	Class	Max. Strip Length	SKU#
VBD-012-024DM	100-130V	12V	24W	IP20	Class 2	8.7ft	666561415761
VBD-012-048DM	100-130V	12V	48W	IP20	Class 2	17.4ft	666561415754
VBD-012-060DM	100-130V	12V	60W	IP20	Class 2	21.8ft	666561415747
VBD-012-096DM	100-130V	12V	96W	IP67	-----	34.9ft	666561415730
VBD-012-150DM	100-130V	12V	150W	IP67	-----	54.5ft	666561415723
VBD-012-200DM	100-130V	12V	200W	IP67	-----	72.7ft	666561415716
VBD-012-300VTHWJ	100-277V	12V	300W	IP65	-----	109ft	666561419790

Dali Dimming Constant Voltage



Model No.	Input Voltage	Output Voltage	Wattage	IP Rating	Class	Max. Strip Length	SKU#
VBD-012-030DD	100-265V AC	12V	30W	IP20	Class 2	11ft	666561427290
VBD-012-060DD	100-265V AC	12V	60W	IP65	Class 2	21.8ft	666561427313
VBD-012-096DD	100-265V AC	12V	96W	IP65	-----	35ft	666561427337
VBD-012-150DD	100-265V AC	12V	150W	IP65	-----	54.5ft	666561427351

Plug-in Drivers



Model No.	Input Voltage	Output Voltage	Wattage	IP Rating	Class	Max. Strip Length	SKU#
VBDA-012-012P1J	100-240V AC	12V	12W	IP20	Class 2	4.3ft	666561428945
VBDA-012-024P1J	100-240V AC	12V	24W	IP20	Class 2	8.7ft	666561428952
VBDA-012-036P1J	100-240V AC	12V	36W	IP20	Class 2	13ft	666561428976
VBDA-012-060P1J	100-240V AC	12V	60W	IP20	-----	21.8ft	666561428990

For more information about our products and services, please visit our website: www.veroboard.com