

# VEROBOARD®

**LED Type:** VBDFS-4020-RGB-144-5-NS  
**Colour:** RGB (SK6812)



## DESCRIPTION

Flexible 10mm wide linear side-emitting digital LED strip. Available in 2 meters (78.7 inches) rolls that can be cut after every LED (6.9 mm or 0.27 in). The LED strip lights are manufactured with high-quality materials and designed for professional lighting. Each LED is addressable and has an integrated IC driver V6842, allowing you total control over the color of each RGB SMD. Moreover, each SMD has a built-in SK6812 Smart Control Circuit. It helps in making the RGB chip in the outer SMD into a fully controlled pixel. The strip light is an intelligent control LED light source integrated into the 4020 side-LED components. They are 144 RGB side-LEDs in a meter and need a 5V DC power supply.

## DIMENSIONS

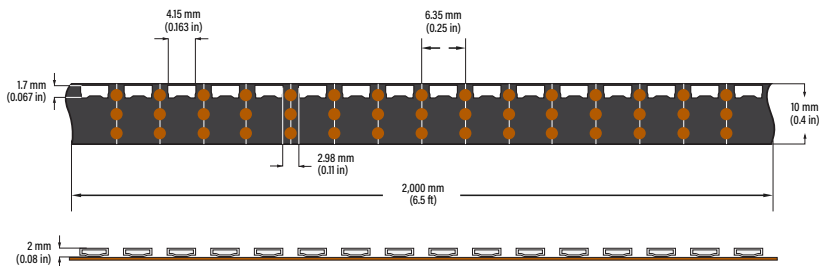

## SPECIFICATIONS

<b>Model:</b>	VBDFS-4020-RGB-144-5-NS
<b>Color Temperature:</b>	RGB (SK6812)
<b>LED Type:</b>	4020 SMD
<b>LED Qty:</b>	144 LEDs per meter
<b>Input Voltage (VF):</b>	5V DC
<b>Power:</b>	14.4W per meter (4.5W/ft)
<b>IC Driver:</b>	V6842 (Built-in)
<b>Lifespan:</b>	>50,000 hours
<b>PCB:</b>	4oz PCB, Double-side, white colour 10mm width
<b>IP Rating:</b>	IP20 (Indoor use only)
<b>Rendering Index (Ra):</b>	CRI>95
<b>Beam Angle:</b>	120°
<b>Dimmable:</b>	Yes
<b>Cut Size:</b>	6.9 mm (0.27")
<b>Operating Temperature:</b>	-40°C to +60°C
<b>Dimensions:</b>	2,000mm x 10mm x 2.7mm (78.7" x 0.39" x 0.1")
<b>Certificates:</b>	UL / RoHs
<b>Roll Length:</b>	2 meter roll (6.5ft)

**Job Name:** \_\_\_\_\_

**Distributor:** \_\_\_\_\_

**Type:** \_\_\_\_\_

	Wattage
Per Foot	4.5W/ft
Per Meter	14.4W/m

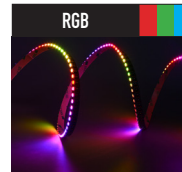

666561425661

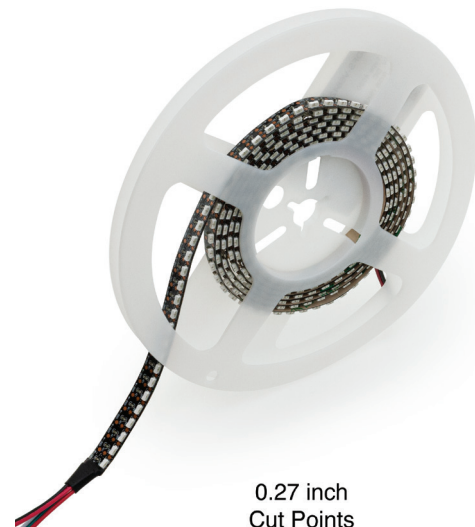

0.27 inch  
Cut Points



## ORDERING GUIDE

Example part number: **VBDFS - 4020 - RGB - 144 - 5 - NS**

MODEL	SERIES	COLOUR	LEDS/METER	VOLTAGE	NS	LENGTH
VBDFS	4020	RGB	144	5V	NS	XXXX

Custom Length  
Full Roll (2 Meter)



For more information about our products and services, please visit our website: [www.veroboard.com](http://www.veroboard.com)

## RECEIVERS (Sold Separately)



**Model:** SR-SPI-OLED(WiFi)

**SKU:** 666561432362

**Compatible Controller:**

- SR-2858Z4 (DMX) **SKU:** 666561433338



**Model:** WT-SPI

**SKU:** 666561433369

**Compatible Controller:**

- R9 **SKU:** 666561433376

To see all available controllers and remote controls, please scan the QR code with your smartphone.



### Disclaimer:

The data and information contained in this specification sheet are subject to change without notice; the ratings supplied are provided based on the product manufacturer. The information contained in this specification sheet should not be considered a warranty, expressed or implied, including, but not limited to, a warranty of merchantability or fitness for a particular purpose. In no event shall Veroboard be liable for any incidental or consequential damages resulting from the use, misuse, or inability to use the product. This exclusion applies regardless of whether such damages are sought based on breach of warranty, breach of contract, negligence, strict liability in tort, or any other legal theory.

## CUSTOM ORDERING GUIDE

**Single Run (Straight Run):** The below ordering guide will be used for single run LED strip.

- **PFL:** Power Feed Length
- **SL:** Strip Length



Example: 2 (QTY) x 36" (PFL) - 84" (SL)  x  -

## CUSTOM ORDERING GUIDE

**Joiner:** LED strip lights need joiners if they are used for curve applications such as corner side, behind a mirror, etc.

- **PFL:** Power Feed Length
- **SL:** Strip Length
- **JL:** Joiner Length

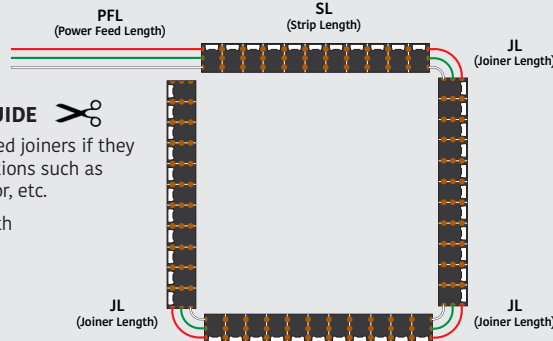

Example: 1 (QTY) x 12" (PFL) - 46" (SL) - 1" (JL) - 36" (SL) - 1" (JL) - 46" (SL) - 1" (JL) - 36" (SL)

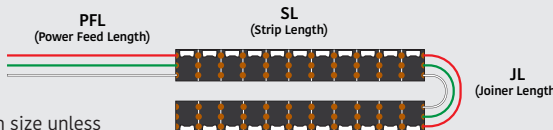

**Note:** Joiners will be 1-inch size unless customers require a specific size.

Example: 2 (QTY) x 24" (PFL) - 52" (SL) - 1" (JL) - 52" (SL)

## RECOMMENDED LED ALUMINUM CHANNELS

(Sold Separately)

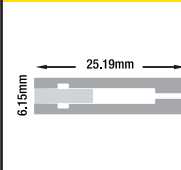
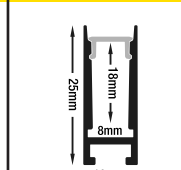
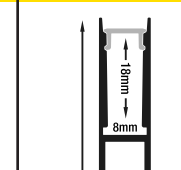
VBD-CH-RF9	VBD-CH-H1	VBD-CH-H2
		
SKU: 666561423421	SKU: 666561428570	SKU: 666561428594

**Notes:** \_\_\_\_\_

\_\_\_\_\_

\_\_\_\_\_

\_\_\_\_\_

\_\_\_\_\_

\_\_\_\_\_

### Disclaimer:

The data and information contained in this specification sheet are subject to change without notice; the ratings supplied are provided based on the product manufacturer. The information contained in this specification sheet should not be considered a warranty, expressed or implied, including, but not limited to, a warranty of merchantability or fitness for a particular purpose. In no event shall Veroboard be liable for any incidental or consequential damages resulting from the use, misuse, or inability to use the product. This exclusion applies regardless of whether such damages are sought based on breach of warranty, breach of contract, negligence, strict liability in tort, or any other legal theory.

For more information about our products and services, please visit our website: [www.veroboard.com](http://www.veroboard.com)