

# VEROBOARD®

**LED Type:** VBDFS-3528-XXXX-60-12-NS  
**Colour:** 3000K • 3500K • 4000K • 5000K

**Job Name:** \_\_\_\_\_

**Distributor:** \_\_\_\_\_

**Type:** \_\_\_\_\_

	Wattage	Brightness
Per Foot	1.5W/ft	128-146Lm/ft
Per Meter	4.5W/m	420-480Lm/m



## DESCRIPTION

Flexible 8 mm wide linear LED strip. Available in 10 meter (32.8 feet) rolls that can be cut every 3 LEDs (50.8 mm or 2 in). The LED Strip lights are manufactured with high-quality materials and designed for professional lighting. Every strip light begins with a heavy-duty dual-core copper printed circuit board (PC Board), it is then soldered with an array of chips and color options. Moreover, the strip lights come with a strong 3M adhesive backing. They can be cut to any size (marked interval points) and rejoined by soldering.

## DIMENSIONS

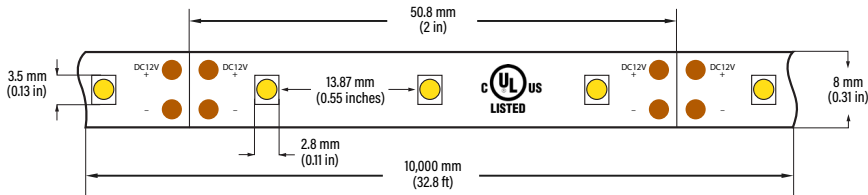

## SPECIFICATIONS

<b>Model:</b>	VBDFS-3528-xxxx-60-12-NS
<b>Color Temperature:</b>	3000K • 3500K • 4000K • 5000K
<b>LED Type:</b>	3528 SMD
<b>LED Qty:</b>	60 LEDs per meter
<b>LM/LED:</b>	7-8 Lm per LED
<b>Input Voltage (VF):</b>	12V DC
<b>Power:</b>	4.5W per meter (1.5W/ft)
<b>Brightness:</b>	420-480 Lm/meter (128-146 Lm/ft)
<b>Lifespan:</b>	>50,000 hours
<b>PCB:</b>	4oz PCB, Double-side, white colour 8mm width
<b>IP Rating:</b>	IP20 (Indoor use only)
<b>Rendering Index (Ra):</b>	CRI>95
<b>Beam Angle:</b>	120°
<b>Dimmable:</b>	Yes
<b>Cut Size:</b>	Every 3 LED chips (2")
<b>Operating Temperature:</b>	-15°C to +40°C
<b>Dimensions:</b>	10,000mm x 8mm x 3mm (393.6" x 0.31" x 0.1")
<b>Certificates:</b>	UL / RoHS
<b>Roll Length:</b>	10 meter roll (32.8ft)



666561423896  666561425593  666561423889



666561423902



Every 2 inch  
Cut Points



## ORDERING GUIDE

Example part number: **VBDFS - 3528 - XXXX - 60 - 12 - NS**

MODEL	SERIES	COLOUR	LEDS/METER	VOLTAGE	LENGTH
VBDFS	3528	XXXX 3000K 3500K 4000K 5000K	60	12V	XXXX Custom Length Full Roll (10 Meter)



For more information about our products and services, please visit our website: [www.veroboard.com](http://www.veroboard.com)

# CONNECTORS (Sold Separately)

Note: Connectors fit in some aluminum channels only.

## 8mm Strip to Wire

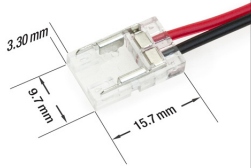

### MODEL: VBD-BC-8MM-1S1W

**Material:** Clear Plastic

**Strip Light Width:** 8mm

**Package Content:** LED Strip to Wire Connectors (Pack of 3)

**Dimensions:** 15.7 x 9.6 x 3.3mm (0.61" x 0.37" x 0.12")

666561428204

\*with 7" wire on each connector

## 8mm Strip to Strip

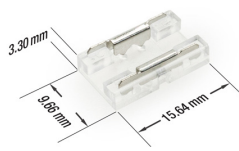

### MODEL: VBD-BC-8MM-2S

**Material:** Clear Plastic

**Strip Light Width:** 8mm

**Package Content:** LED Strip to Strip Connectors (Pack of 3)

**Dimensions:** 15.7 x 9.7 x 3.5mm (0.61" x 0.38" x 0.13")

666561428181

## 8mm Strip to Strip

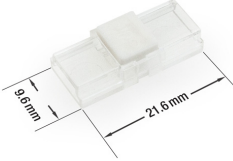

### MODEL: VBD-CON-8MM-2S

**Material:** Clear Plastic

**Strip Light Width:** 8mm

**Package Content:** LED Strip to Strip Connectors (Pack of 5)

**Dimensions:** 22 x 9.6 x 4.4mm (0.86" x 0.37" x 0.17")

666561424602

## 8mm Strip to Wire

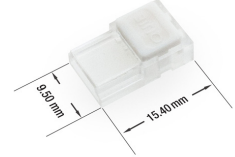

### MODEL: VBD-CON-8MM-1S1W

**Material:** Clear Plastic

**Strip Light Width:** 8mm

**Package Content:** LED Strip to Wire Connectors (Pack of 5)

**Dimensions:** 15.5 x 9.5 x 4.3mm (0.61" x 0.37" x 0.16")

666561424596

\*Wire is NOT included

## 8mm Strip to Strip

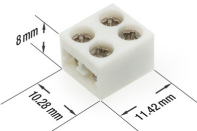

### MODEL: VBD-CON-SC8MM-SW

**Material:** Plastic

**Strip Light Width:** 8mm

**Package Content:** LED Strip to Wire Connectors (Pack of 3)

**Dimensions:** 11.3 x 10.3 x 8mm (0.44" x 0.4" x 0.31")

666561427443

## 8mm PCB

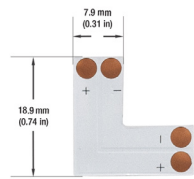

### MODEL: VBD-FPC10-L2A PCB

**Material:** PCB

**Strip Light Width:** 8mm

**Package Content:** L Shape PCB Connectors (Pack of 3)

666561430443

## 8mm PCB

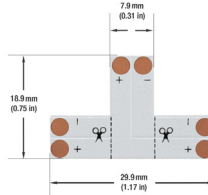

### MODEL: VBD-FPC8-T2A

**Material:** PCB

**Strip Light Width:** 8mm

**Package Content:** T Shape PCB Connectors (Pack of 3)

666561430450

## 8mm PCB

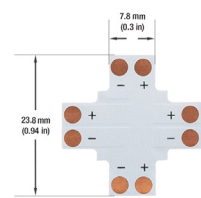

### MODEL: VBD-FPC8-C2A

**Material:** PCB

**Strip Light Width:** 8mm

**Package Content:** 4 Way PCB Connectors (Pack of 3)

666561430467

# Light Measurement Report

Print date: 2023-04-26

Measurement date and time: 2023-04-25 2:01:07 PM – Measurement no. VFR-230425-0166-MS

## Luminous Intensity diagram

Unit: 0-100% of peak intensity

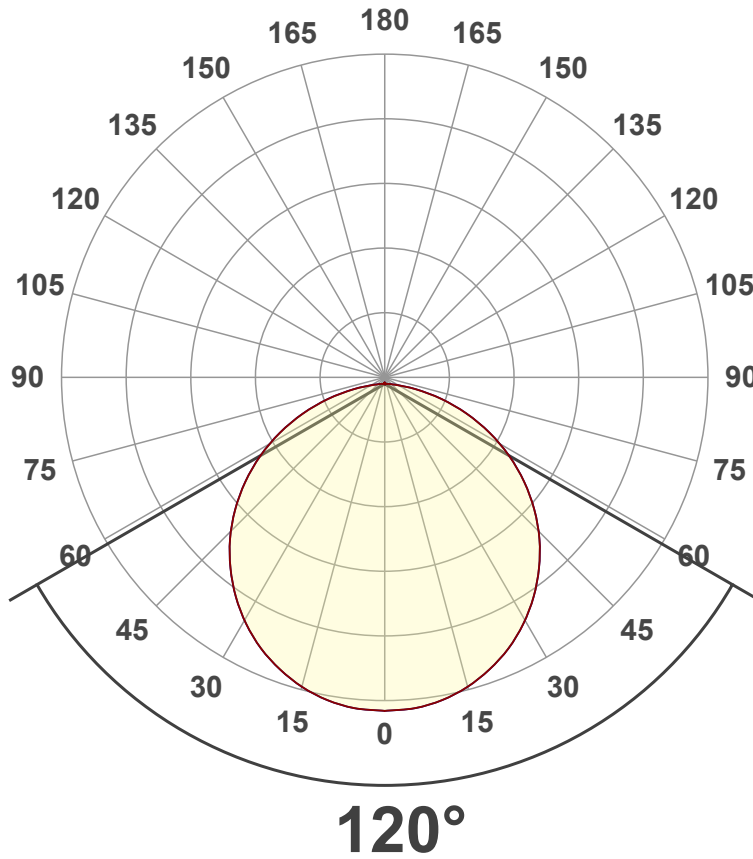

## Main Values

Lumen Up% / Down%	0.48% / 99.52%
Peak Intensity	41.3 cd
Beam Angle (50%)	120°
Beam Angle (90%)	114.1°
Beam Angle (10%)	114.1°

## Cut-off Angle

Average 2,5%	173.3°
--------------	--------

## Field Angle

Average 10%	160.5°
-------------	--------

## Intensity Ratio

In 120° cone	78.6%
In 90° cone	53.2%

**C000-C180**  
**C090-C270**

## Linear distribution diagram - Intensity (candela) vs $\gamma$ -angle

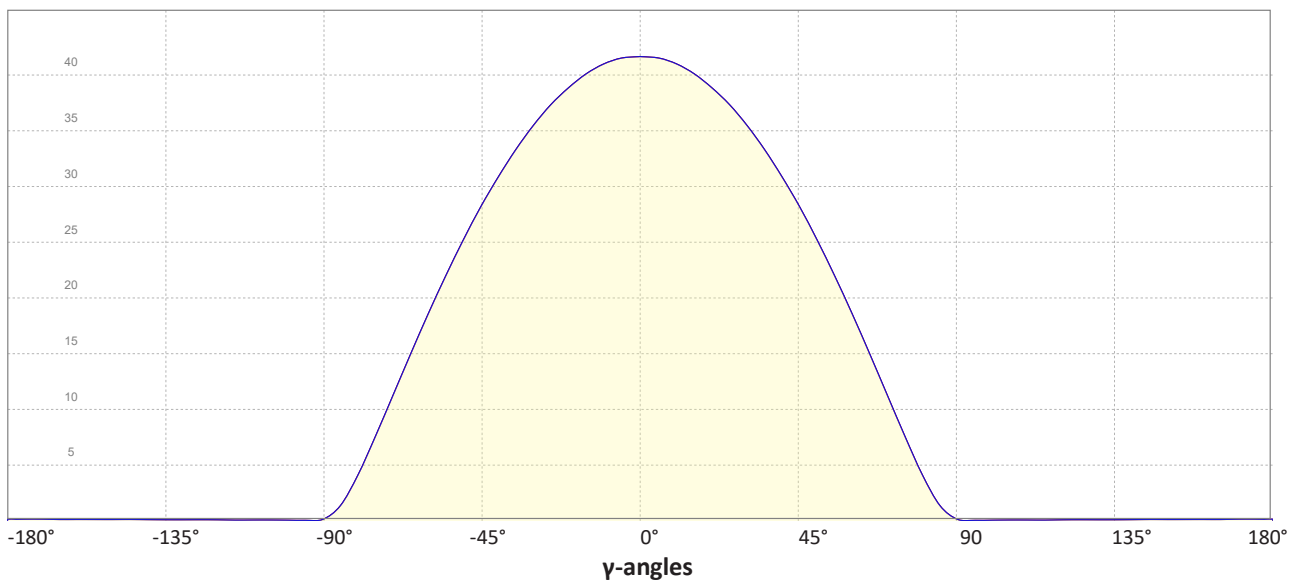

# Light Measurement Report

Print date: 2023-04-26

Measurement date and time: 2023-04-25 2:01:07 PM – Measurement no. VFR-230425-0166-MS

## Color details

Correlated Color Temperature, Target CCT = 3000 K  
 Correlated Color Temperature, Measured CCT = 2959 K  
 Color Rendering Index CRI 98.2  
 Color Rendering Index, R9 (red component) R9 = 98.1  
 Color Rendering TM30-18 R<sub>f</sub> 94.2 – R<sub>g</sub> 100.5  
 Color Quality Scale CQS = 95.5

MacAdam Steps  
 Color coordinates CIE 1931 (x;y) = (0.437;0.404)  
 Color coordinate CIEs 1960 (u';v') = (0.251;0.348)  
 Color deviation from BBL Duv = -0.0005  
 Color coordinate CIEs 1976 (CIELUV) (u'';v'') = (0.251;0.251)

CIE 1931

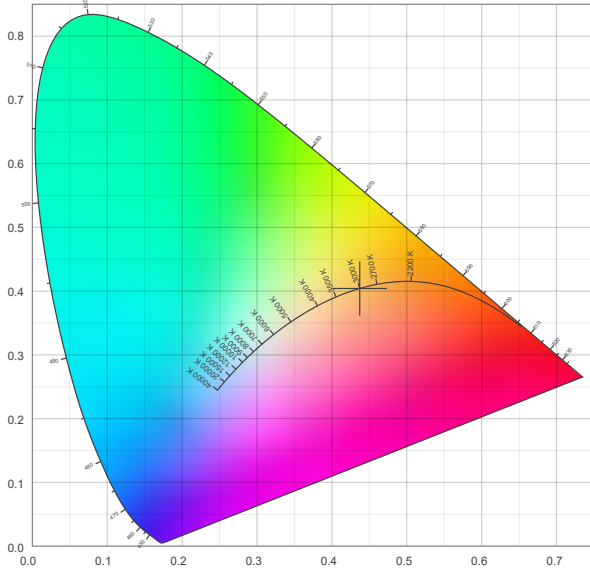

CIE 1931 – zoomed on Planckian locus

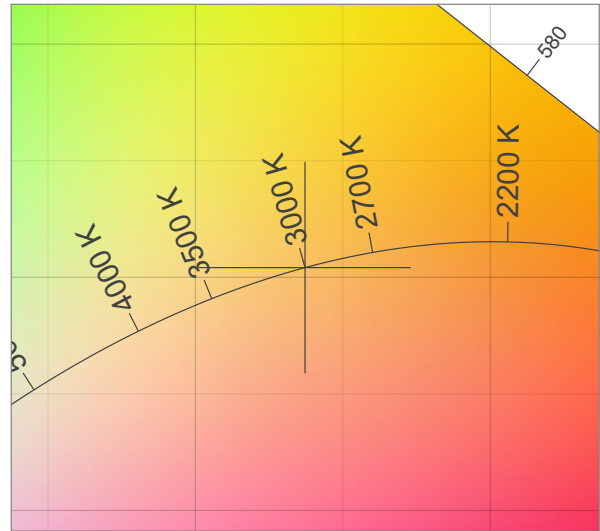

Color Rendering Index per reference color (CIE 1995)

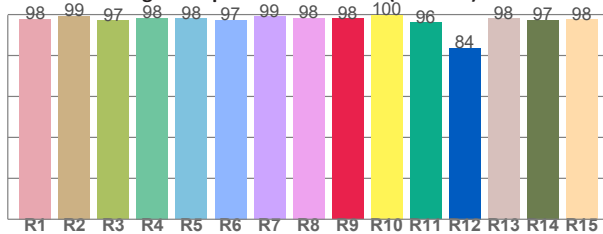

CRI R values, only R1-R8 are used to calculate final CRI value

R1	R2	R3	R4	R5	R6	R7	R8	R9	R10	R11	R12	R13	R14	R15
97.8	99.3	97.1	98.3	98.2	97.4	99.0	98.4	98.1	99.9	96.1	83.6	98.1	97.4	97.8

Spectral power distribution (SPD) / W/nm – 0-100%

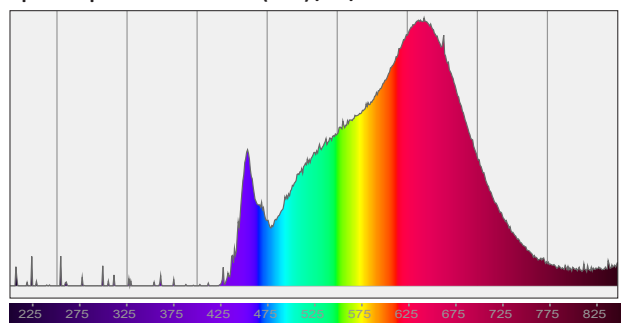

TM30-18 Rf-values per hue bin

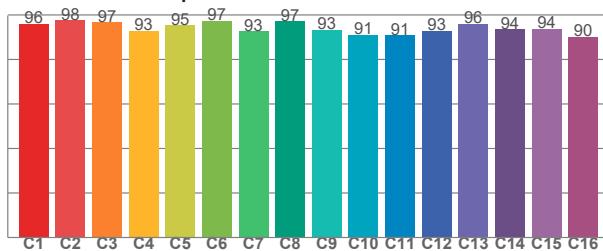

TM30 C values, 16 binned values out of total of 99 C values

C1	C2	C3	C4	C5	C6	C7	C8	C9	C10	C11	C12	C13	C14	C15	C16
96.1	97.7	96.7	92.9	95.3	97.3	92.7	97.2	93.4	91.0	90.8	92.9	96.0	93.6	93.9	90.3

Color Quality Scale by reference color

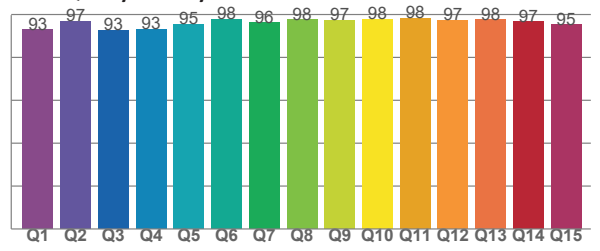

CQS Q values

Q1	Q2	Q3	Q4	Q5	Q6	Q7	Q8	Q9	Q10	Q11	Q12	Q13	Q14	Q15
92.9	96.9	92.7	93.1	95.4	97.9	96.2	97.6	97.3	97.9	98.1	97.5	97.6	96.5	95.2

# Light Measurement Report

Print date: 2023-04-26

Measurement date and time: 2023-04-25 2:01:07 PM – Measurement no. VFR-230425-0166-MS

## Beam Details

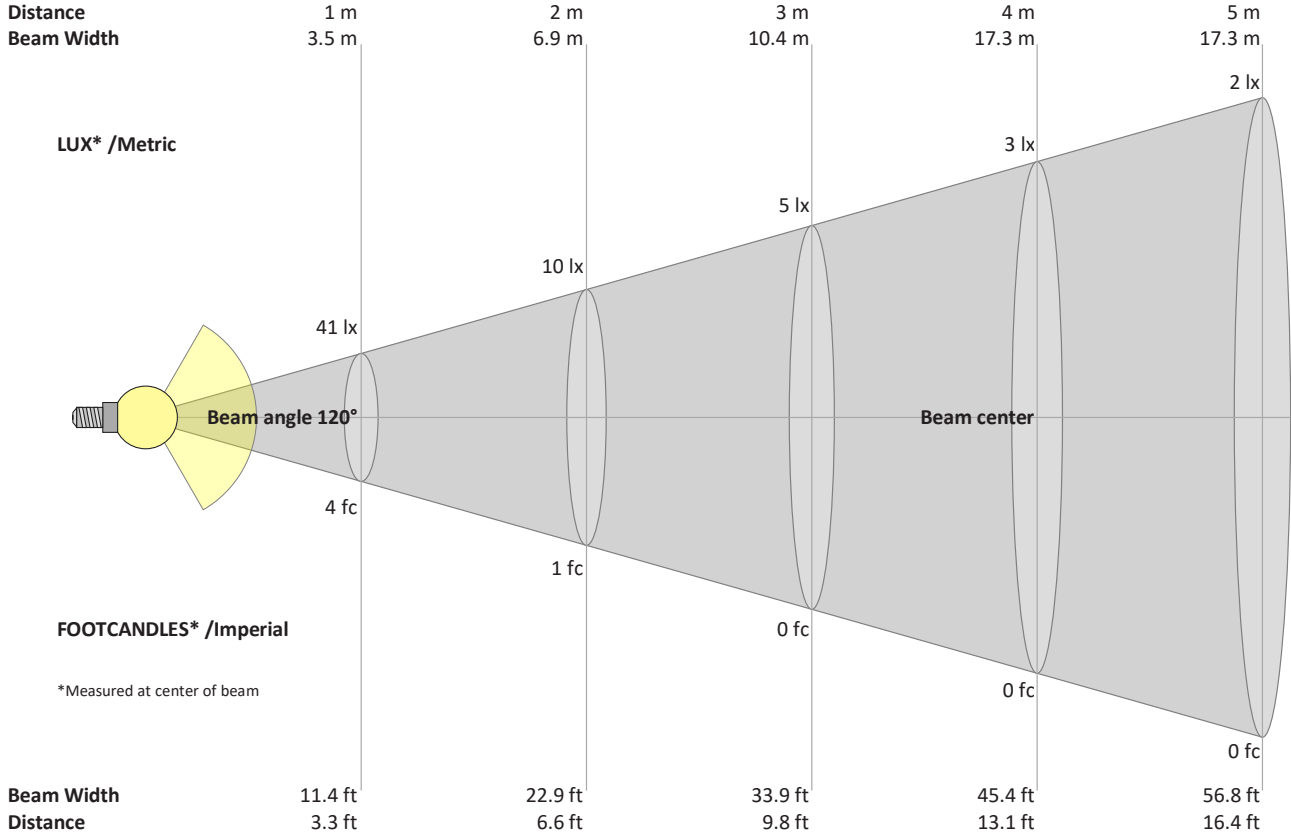

### Beam intensities from 1 – 20 m

1	2	3	4	5	6	7	8	9	10	11	12	13	14	15	16	17	18	19	20	m
3.3	6.6	9.8	13.1	16.4	19.7	23	26.2	29.5	32.8	36.1	39.4	42.7	45.9	49.2	52.5	55.8	59.1	62.3	65.6	ft
41	10	5	3	2	1	1	1	1	0	0	0	0	0	0	0	0	0	0	0	lux
3.8	1	0.4	0.2	0.2	0.1	0.1	0.1	0	0	0	0	0	0	0	0	0	0	0	0	fc

### Intensities in 0° c-plane

0°	5°	10°	15°	20°	25°	30°	35°	40°	45°	50°	55°	60°	65°	70°	75°	80°	85°	90°	95°	y
41.3	41.2	40.7	39.8	38.6	37.1	35.3	33.2	30.8	28.1	25.2	22.0	18.6	15.1	11.4	7.8	4.3	1.5	0.2	0.1	cd
100%	100%	99%	96%	94%	90%	86%	80%	75%	68%	61%	53%	45%	37%	28%	19%	10%	4%	1%	0%	of 0°val

### Intensities in 90° c-plane

0°	5°	10°	15°	20°	25°	30°	35°	40°	45°	50°	55°	60°	65°	70°	75°	80°	85°	90°	95°	y
41.3	41.2	40.7	39.8	38.6	37.1	35.3	33.2	30.8	28.1	25.2	22.0	18.6	15.1	11.4	7.8	4.3	1.5	0.2	0.1	cd
100%	100%	99%	96%	94%	90%	86%	80%	75%	68%	61%	53%	45%	37%	28%	19%	10%	4%	1%	0%	of 0°val

### Intensities in 180° c-plane

0°	5°	10°	15°	20°	25°	30°	35°	40°	45°	50°	55°	60°	65°	70°	75°	80°	85°	90°	95°	y
41.3	41.2	40.7	39.8	38.6	37.1	35.3	33.2	30.8	28.1	25.2	22.0	18.6	15.1	11.4	7.8	4.3	1.5	0.2	0.1	cd
100%	100%	99%	96%	94%	90%	86%	80%	75%	68%	61%	53%	45%	37%	28%	19%	10%	4%	1%	0%	of 0°val

### Intensities in 270° c-plane

0°	5°	10°	15°	20°	25°	30°	35°	40°	45°	50°	55°	60°	65°	70°	75°	80°	85°	90°	95°	y
41.3	41.2	40.7	39.8	38.6	37.1	35.3	33.2	30.8	28.1	25.2	22.0	18.6	15.1	11.4	7.8	4.3	1.5	0.2	0.1	cd
100%	100%	99%	96%	94%	90%	86%	80%	75%	68%	61%	53%	45%	37%	28%	19%	10%	4%	1%	0%	of 0°val

## CUSTOM ORDERING GUIDE ✂

**Single Run (Straight Run):** The below ordering guide will be used for single run LED strip.

- **PFL:** Power Feed Length
- **SL:** Strip Length

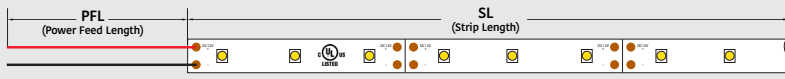

Example: 2 (QTY) x 36" (PFL) - 84" (SL)  x  -

## CUSTOM ORDERING GUIDE ✂

**Joiner:** LED strip lights need joiners if they are used for curve applications such as corner side, behind a mirror, etc.

- **PFL:** Power Feed Length
- **SL:** Strip Length
- **JL:** Joiner Length

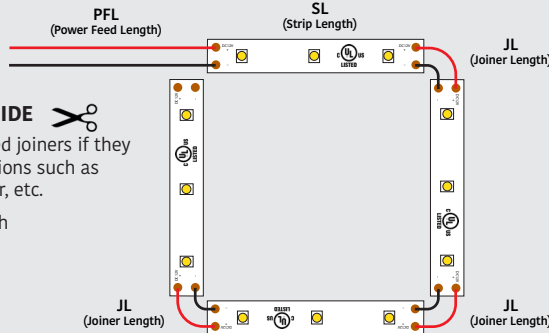

x  -  -  -  -  -  -  -

Example: 1 (QTY) x 12" (PFL) - 46" (SL) - 1" (JL) - 36" (SL) - 1" (JL) - 46" (SL) - 1" (JL) - 36" (SL)

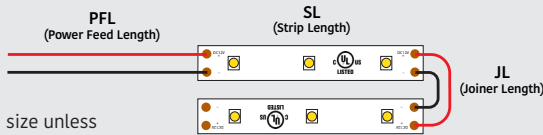

**Note:** Joiners will be 1-inch size unless customers require a specific size.

x  -  -  -





Example: 2 (QTY) x 24" (PFL) - 52" (SL) - 1" (JL) - 52" (SL)

## RECOMMENDED LED ALUMINUM CHANNELS

(Sold Separately)

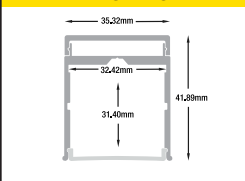
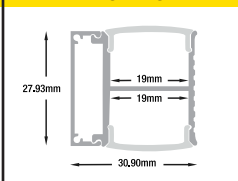
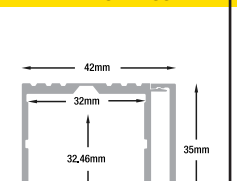
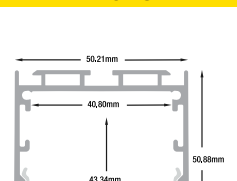
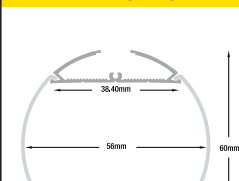
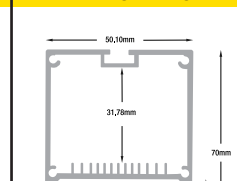
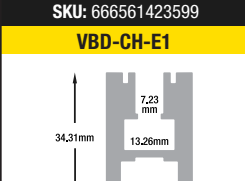
<b>VBD-CH-S4</b>  15.5mm, 12mm, 17.5mm	<b>VBD-CH-S4B</b>  15.5mm, 12mm, 17.5mm	<b>VBD-CH-S6</b>  10.6mm, 20.15mm, 23.44mm
SKU: 666561423278	SKU: 666561423285	SKU: 666561423315
<b>VBD-CH-S5</b>  6mm, 13mm, 17mm	<b>VBD-CH-S5B</b>  6mm, 13mm, 17mm	<b>VBD-CH-B1</b>  6.14mm, 13.89mm, 18.77mm
SKU: 666561423292	SKU: 666561423308	SKU: 666561423360
<b>VBD-CH-C2</b>  18.5mm, 14mm, 18.5mm	<b>VBD-CH-C2B</b>  18.5mm, 14mm, 18.5mm	<b>VBD-CH-RF4</b>  23.4mm, 18.6mm, 18.6mm
SKU: 666561423506	SKU: 666561423513	SKU: 666561423377
<b>VBD-CH-RF1</b>  12.5mm, 15mm, 17mm	<b>VBD-CH-RF1B</b>  12.5mm, 15mm, 17mm	<b>VBD-CH-C1</b>  25.68mm, 15.07mm, 21.19mm
SKU: 666561423339	SKU: 666561423346	SKU: 666561423490
<b>VBD-CH-C3</b>  30mm, 20mm, 20mm, 30mm	<b>VBD-CH-C3B</b>  30mm, 20mm, 20mm, 30mm	<b>VBD-CH-W1</b>  26.16mm, 12mm, 21.43mm
SKU: 666561423520	SKU: 666561423537	SKU: 666561423445
<b>VBD-CH-RF7</b>  32.16mm, 75mm, 58mm, 25.50mm, 71mm, 90mm	<b>VBD-CH-RF8</b>  32mm, 70.15mm, 23.50mm, 75mm	<b>VBD-CH-S2</b>  9.28mm, 56.75mm, 17.29mm, 13.22mm
SKU: 666561423407	SKU: 666561423414	SKU: 666561423254
<b>VBD-CH-WC4</b>  45.50mm, 85mm, 26.72mm, 57.68mm, 14.67mm, 32.28mm, 37.85mm	<b>VBD-CH-WC5</b>  39mm, 43.03mm, 53.84mm, 182mm, 43.03mm	<b>VBD-CH-ST2</b>  21mm, 95mm, 13mm
SKU: 666561423629	SKU: 666561423636	SKU: 666561423582
<b>VBD-CH-S3</b>  55.38mm, 13.56mm, 7.96mm	<b>VBD-CH-RF6</b>  31.90mm, 46.42mm, 23.80mm, 50.20mm	<b>VBD-CH-RF5</b>  32mm, 30.84mm, 35.65mm, 34.79mm
SKU: 666561423261	SKU: 666561423391	SKU: 666561423384
<b>VBD-CH-R2</b>  25.95mm, 22.94mm, 17.46mm, 21.84mm	<b>VBD-CH-R2B</b>  25.95mm, 22.94mm, 17.46mm, 21.84mm	<b>VBD-CH-D10</b>  136mm, 13.66mm, 12mm, 19mm
SKU: 666561423742	SKU: 666561428280	SKU: 666561420023

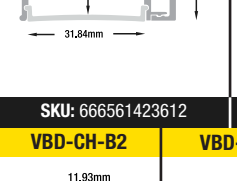
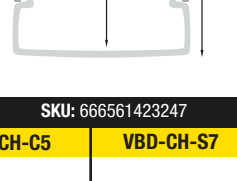
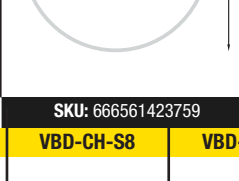
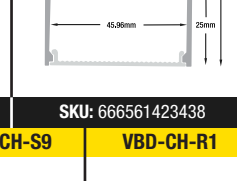
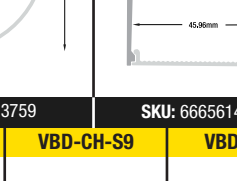
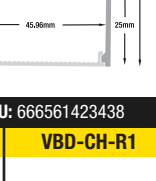
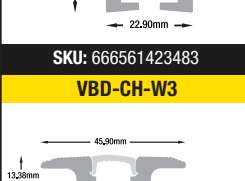
For more information about our products and services, please visit our website: [www.veroboard.com](http://www.veroboard.com)

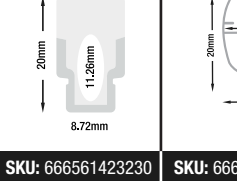
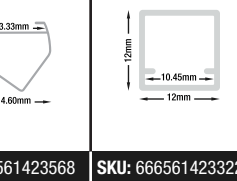
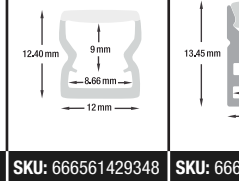
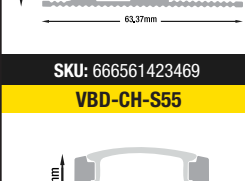
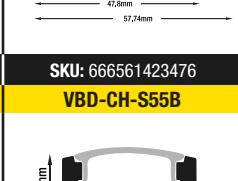
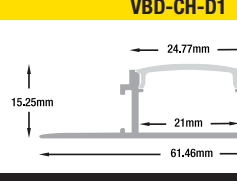
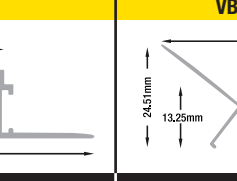
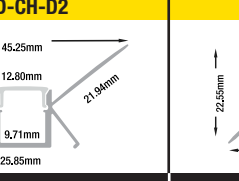
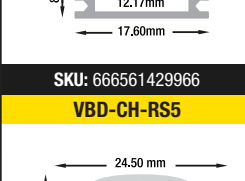
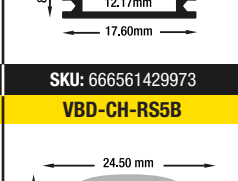
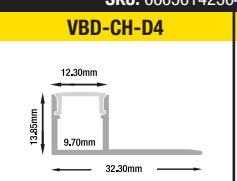
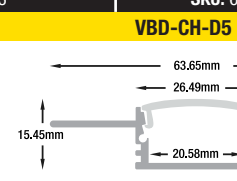
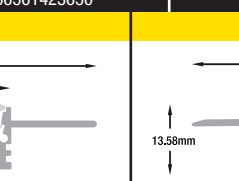
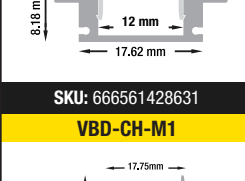
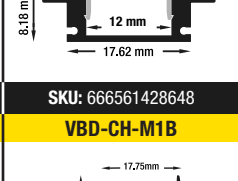
<b>VBD-CH-WC1</b>  SKU: 666561423599	<b>VBD-CH-WC2</b>  SKU: 666561423605	<b>VBD-CH-WC3</b>  SKU: 666561423612	<b>VBD-CH-S1</b>  SKU: 666561423247	<b>VBD-CH-R3</b>  SKU: 666561423759	<b>VBD-CH-RF10</b>  SKU: 666561423438		
<b>VBD-CH-E1</b>  SKU: 666561423483	<b>VBD-CH-W2</b>  SKU: 666561423452	<b>VBD-CH-B2</b>  SKU: 666561423230	<b>VBD-CH-C5</b>  SKU: 666561423568	<b>VBD-CH-S7</b>  SKU: 666561423322	<b>VBD-CH-S8</b>  SKU: 666561429348	<b>VBD-CH-S9</b>  SKU: 666561429355	<b>VBD-CH-R1</b>  SKU: 666561423735
<b>VBD-CH-W3</b>  SKU: 666561423469	<b>VBD-CH-W4</b>  SKU: 666561423476	<b>VBD-CH-D1</b>  SKU: 666561423643	<b>VBD-CH-D2</b>  SKU: 666561423650	<b>VBD-CH-D3</b>  SKU: 666561423667			
<b>VBD-CH-S55</b>  SKU: 666561429966	<b>VBD-CH-S55B</b>  SKU: 666561429973	<b>VBD-CH-D4</b>  SKU: 666561423674	<b>VBD-CH-D5</b>  SKU: 666561423681	<b>VBD-CH-D6</b>  SKU: 666561423698			
<b>VBD-CH-RS5</b>  SKU: 666561428631	<b>VBD-CH-RS5B</b>  SKU: 666561428648	<b>VBD-CH-D7</b>  SKU: 666561423704	<b>VBD-CH-D8</b>  SKU: 666561423711	<b>VBD-CH-D9</b>  SKU: 666561423728			
<b>VBD-CH-M1</b>  SKU: 666561423773	<b>VBD-CH-M1B</b>  SKU: 666561431013						

**Note:** To avoid a dark spot on the sides of these channels (RF10, RF6, RF8, R3, S1, R3) we recommend installing more than one Run LED Strip. For more details please contact us at [sales@veroboard.com](mailto:sales@veroboard.com)

## RECOMMENDED LED POWER SUPPLIES (Sold Separately)

For more options and varieties, please visit our website: [www.veroboard.com](http://www.veroboard.com)

Constant Voltage Dimmable LED Drivers (5 in 1), Triac/Phase, 0-10V, 1-10V, Potentiometer, 10V PWM 5 in 1 Dimming



Model No.	Input Voltage	Output Voltage	Wattage	IP Rating	Class	Max. Strip Length	SKU#
VBD-012-030C2DM5i1	100-277V	12V	30W	IP67	Class 2	16ft	666561425999
VBD-012-060C2DM5i1	100-277V	12V	60W	IP67	Class 2	32ft	666561426002
VBD-012-100C2DM5i1	100-277V	12V	100W	IP65	Type HL	53.3ft	666561428426
VBD-012-150C2DM5i1	100-277V	12V	150W	IP65	Type HL	80ft	666561428433
VBD-012-180C2DM5i1	100-277V	12V	180W (3x60W)	IP67	Class 2	96ft	666561426019
VBD-012-300C2DM5i1	100-277V	12V	300W (5x60W)	IP67	Class 2	160ft	666561426026

For more information about our products and services, please visit our website: [www.veroboard.com](http://www.veroboard.com)

## Constant Voltage Triac LED Drivers forward Phase, Magnetic Low Voltage & Triac Dimmers



Model No.	Input Voltage	Output Voltage	Wattage	IP Rating	Class	Max. Strip Length	SKU#
VBD-012-024DM	100-130V	12V	24W	IP20	Class 2	13ft	666561415761
VBD-012-048DM	100-130V	12V	48W	IP20	Class 2	25.6ft	666561415754
VBD-012-060DM	100-130V	12V	60W	IP20	Class 2	32ft	666561415747
VBD-012-096DM	100-130V	12V	96W	IP67	-	51.2ft	666561415730
VBD-012-150DM	100-130V	12V	150W	IP67	-	80ft	666561415723
VBD-012-200DM	100-130V	12V	200W	IP67	-	106.5ft	666561415716
VBD-012-300VTHWJ	100-277V	12V	300W	IP65	-	160ft	666561419790

## Dali Dimming Constant Voltage



Model No.	Input Voltage	Output Voltage	Wattage	IP Rating	Class	Max. Strip Length	SKU#
VBD-012-030DD	100-265V AC	12V	30W	IP20	Class 2	16ft	666561427290
VBD-012-060DD	100-265V AC	12V	60W	IP65	Class 2	32ft	666561427313
VBD-012-096DD	100-265V AC	12V	96W	IP65	-----	51.2ft	666561427337
VBD-012-150DD	100-265V AC	12V	150W	IP65	-----	80ft	666561427351

## Plug-in Drivers



Model No.	Input Voltage	Output Voltage	Wattage	IP Rating	Class	Max. Strip Length	SKU#
VBDA-012-012P1J	100-240V AC	12V	12W	IP20	Class 2	6.4ft	666561428945
VBDA-012-024P1J	100-240V AC	12V	24W	IP20	Class 2	12.8ft	666561428952
VBDA-012-036P1J	100-240V AC	12V	36W	IP20	Class 2	19.2ft	666561428976
VBDA-012-060P1J	100-240V AC	12V	60W	IP20	-----	32ft	666561428990

**Notes:** \_\_\_\_\_

\_\_\_\_\_

\_\_\_\_\_

\_\_\_\_\_

\_\_\_\_\_

\_\_\_\_\_

\_\_\_\_\_

### Disclaimer:

The data and information contained in this specification sheet are subject to change without notice; the ratings supplied are provided based on the product manufacturer. The information contained in this specification sheet should not be considered a warranty, expressed or implied, including, but not limited to, a warranty of merchantability or fitness for a particular purpose. In no event shall Veroboard be liable for any incidental or consequential damages resulting from the use, misuse, or inability to use the product. This exclusion applies regardless of whether such damages are sought based on breach of warranty, breach of contract, negligence, strict liability in tort, or any other legal theory.

For more information about our products and services, please visit our website: [www.veroboard.com](http://www.veroboard.com)