

VEROBOARD®

LED Type: VBDFS-3528-Blue-120-12-NS
Colour: BLUE

	Wattage
Per Foot	3W/ft
Per Meter	9.6W/m



Job Name: _____

Distributor: _____

Type: _____



□ 666561409197

DESCRIPTION

Flexible 8 mm wide linear LED strip. Available in 5 meter (16.4 feet) rolls that can be cut every 3 LEDs (25.4 mm or 1 in). The LED Strip lights are manufactured with high-quality materials and designed for professional lighting. Every strip light begins with a heavy-duty dual-core copper printed circuit board (PC Board), which is then soldered with an array of chips and color options. Moreover, the strip lights come with a strong 3M adhesive backing. They can be cut to any size (marked interval points) and rejoined by soldering.

DIMENSIONS

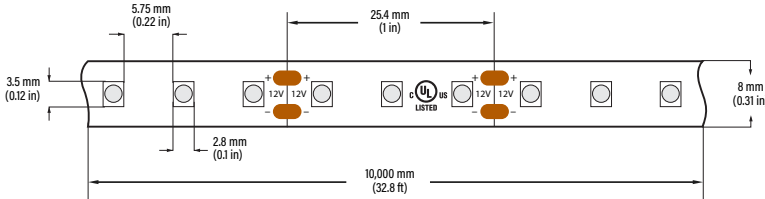

SPECIFICATIONS

Model:	VBDFS-3528-Blue-120-12-NS
Color Temperature:	Blue
LED Type:	3528 SMD
LED Qty:	120 LEDs per meter
Input Voltage (VF):	12V DC
Power:	9.6W per meter (3W/ft)
Lifespan:	>50,000 hours
PCB:	4oz PCB, Double-side, white colour 8mm width
IP Rating:	IP20 (Indoor use only)
Rendering Index (Ra):	CRI>95
Beam Angle:	120°
Dimmable:	Yes
Cut Size:	Every 3 LED chips (1 inches)
Operating Temperature:	-15°C to +40°C
Dimensions:	5,000mm x 8mm (196.8in x 0.31in)
Certificates:	UL / RoHs
Roll Length:	5 meter roll (16.4 feet)

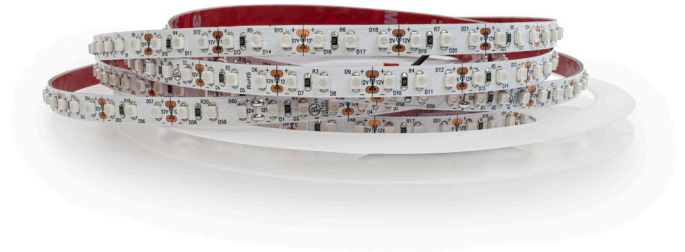

Disclaimer:

The data and information contained in this specification sheet are subject to change without notice; the ratings supplied are provided based on the product manufacturer. The information contained in this specification sheet should not be considered a warranty, expressed or implied, including, but not limited to, a warranty of merchantability or fitness for a particular purpose. In no event shall Veroboard be liable for any incidental or consequential damages resulting from the use, misuse, or inability to use the product. This exclusion applies regardless of whether such damages are sought based on breach of warranty, breach of contract, negligence, strict liability in tort, or any other legal theory.

For more information about our products and services, please visit our website: www.veroboard.com

CONNECTORS (Sold Separately)

Note: Connectors fit in some aluminum channels only.

8mm Strip to Wire

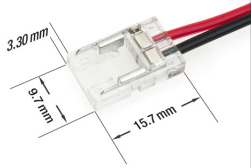

MODEL: VBD-BC-8MM-1S1W

Material: Clear Plastic

Strip Light Width: 8mm

Package Content: LED Strip to Wire Connectors (Pack of 3)

Dimensions: 15.7 x 9.6 x 3.3mm (0.61" x 0.37" x 0.12")

666561428204

*with 7" wire on each connector

8mm Strip to Strip

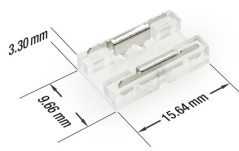

MODEL: VBD-BC-8MM-2S

Material: Clear Plastic

Strip Light Width: 8mm

Package Content: LED Strip to Strip Connectors (Pack of 3)

Dimensions: 15.7 x 9.7 x 3.5mm (0.61" x 0.38" x 0.13")

666561428181

8mm Strip to Strip

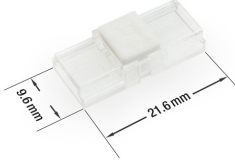

MODEL: VBD-CON-8MM-2S

Material: Clear Plastic

Strip Light Width: 8mm

Package Content: LED Strip to Strip Connectors (Pack of 5)

Dimensions: 22 x 9.6 x 4.4mm (0.86" x 0.37" x 0.17")

666561424602

8mm Strip to Wire

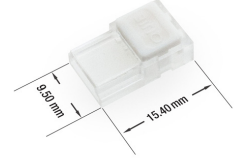

MODEL: VBD-CON-8MM-1S1W

Material: Clear Plastic

Strip Light Width: 8mm

Package Content: LED Strip to Wire Connectors (Pack of 5)

Dimensions: 15.5 x 9.5 x 4.3mm (0.61" x 0.37" x 0.16")

666561424596

*Wire is NOT included

8mm Strip to Strip

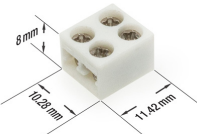

MODEL: VBD-CON-SC8MM-SW

Material: Plastic

Strip Light Width: 8mm

Package Content: LED Strip to Wire Connectors (Pack of 3)

Dimensions: 11.3 x 10.3 x 8mm (0.44" x 0.4" x 0.31")

666561427443

8mm PCB

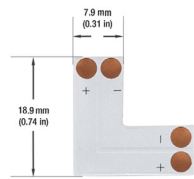

MODEL: VBD-FPC10-L2A PCB

Material: PCB

Strip Light Width: 8mm

Package Content: L Shape PCB Connectors (Pack of 3)

666561430443

8mm PCB

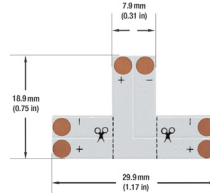

MODEL: VBD-FPC8-T2A

Material: PCB

Strip Light Width: 8mm

Package Content: T Shape PCB Connectors (Pack of 3)

666561430450

8mm PCB

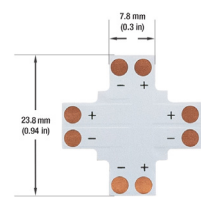

MODEL: VBD-FPC8-C2A

Material: PCB

Strip Light Width: 8mm

Package Content: 4 Way PCB Connectors (Pack of 3)

666561430467

CUSTOM ORDERING GUIDE ✂

Single Run (Straight Run): The below ordering guide will be used for single run LED strip.

- **PFL:** Power Feed Length
- **SL:** Strip Length

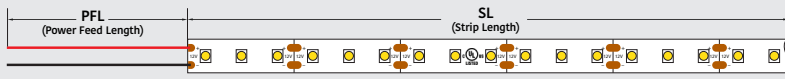

Example: 2 (QTY) x 36" (PFL) - 84" (SL) x -

CUSTOM ORDERING GUIDE ✂

Joiner: LED strip lights need joiners if they are used for curve applications such as corner side, behind a mirror, etc.

- **PFL:** Power Feed Length
- **SL:** Strip Length
- **JL:** Joiner Length

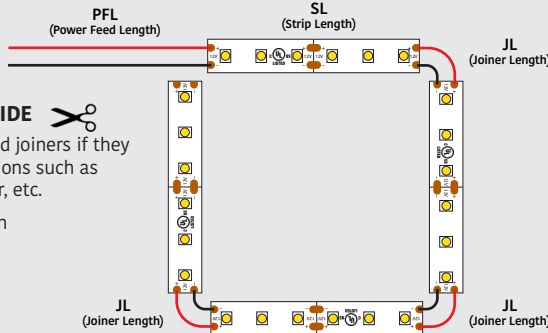

x - - - - - - -

Example: 1 (QTY) x 12" (PFL) - 46" (SL) - 1" (JL) - 36" (SL) - 1" (JL) - 46" (SL) - 1" (JL) - 36" (SL)

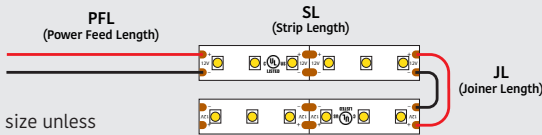

Note: Joiners will be 1-inch size unless customers require a specific size.

x - - -



Example: 2 (QTY) x 24" (PFL) - 52" (SL) - 1" (JL) - 52" (SL)

RECOMMENDED LED ALUMINUM CHANNELS

(Sold Separately)

VBD-CH-S4 15.5mm x 12mm x 17.5mm	VBD-CH-S4B 15.5mm x 12mm x 17.5mm	VBD-CH-S6 10.6mm x 20.15mm x 23.44mm
SKU: 666561423278	SKU: 666561423285	SKU: 666561423315
VBD-CH-S5 6mm x 13mm x 17mm	VBD-CH-S5B 6mm x 13mm x 17mm	VBD-CH-B1 6.14mm x 13.89mm x 18.77mm
SKU: 666561423292	SKU: 666561423308	SKU: 666561423360
VBD-CH-C2 18.5mm x 14mm x 18.5mm	VBD-CH-C2B 18.5mm x 14mm x 18.5mm	VBD-CH-RF4 23.4mm x 18.6mm
SKU: 666561423506	SKU: 666561423513	SKU: 666561423377
VBD-CH-RF1 12.5mm x 15mm x 17mm	VBD-CH-RF1B 12.5mm x 15mm x 17mm	VBD-CH-C1 25.68mm x 15.07mm x 21.19mm
SKU: 666561423339	SKU: 666561423346	SKU: 666561423490
VBD-CH-C3 30mm x 20mm x 30mm	VBD-CH-C3B 30mm x 20mm x 30mm	VBD-CH-W1 26.16mm x 12mm x 21.43mm
SKU: 666561423520	SKU: 666561423537	SKU: 666561423445
VBD-CH-RF7 32.16mm x 75mm x 90mm	VBD-CH-RF8 32mm x 70.15mm x 75mm	VBD-CH-S2 9.28mm x 56.75mm x 17.29mm x 13.22mm
SKU: 666561423407	SKU: 666561423414	SKU: 666561423254
VBD-CH-WC4 45.50mm x 85mm x 37.85mm	VBD-CH-WC5 39mm x 43.0mm x 53.84mm x 102mm	VBD-CH-ST2 21mm x 95mm x 13mm
SKU: 666561423629	SKU: 666561423636	SKU: 666561423582
VBD-CH-S3 55.38mm x 13.56mm x 7.96mm	VBD-CH-RF6 31.90mm x 46.42mm x 23.80mm x 50.20mm	VBD-CH-RF5 32mm x 30.84mm x 35.65mm x 34.79mm
SKU: 666561423261	SKU: 666561423391	SKU: 666561423384
VBD-CH-RF2 11mm x 12.15mm x 21.45mm	VBD-CH-RF3 27mm x 20mm x 17mm	VBD-CH-D10 136mm x 13.66mm x 12mm x 19mm
SKU: 666561423353	SKU: 666561423360	SKU: 666561420023
VBD-CH-R2 25.95mm x 22.94mm x 17.46mm x 21.84mm	VBD-CH-R2B 25.95mm x 22.94mm x 17.46mm x 21.84mm	
SKU: 666561423742	SKU: 666561428280	

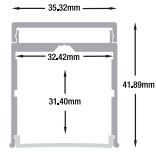
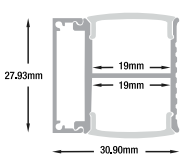
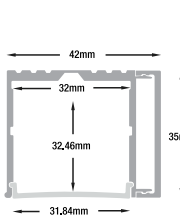
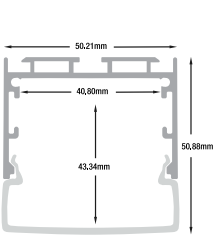
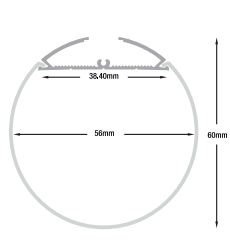
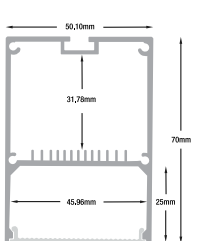
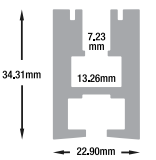
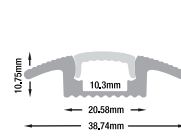
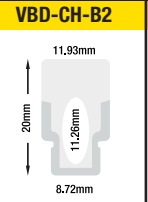
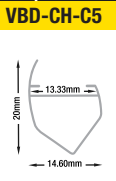
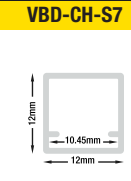
For more information about our products and services, please visit our website: www.veroboard.com

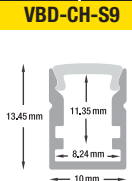
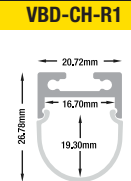
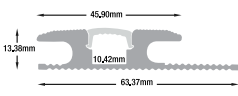
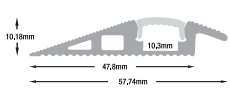
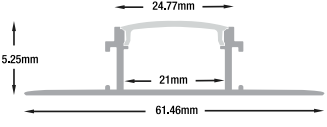
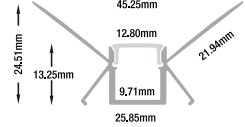
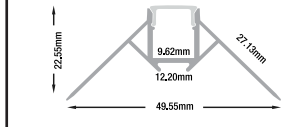
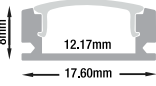
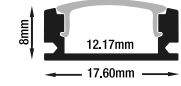
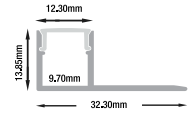
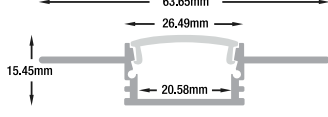
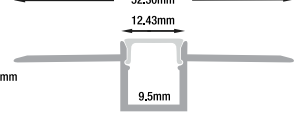
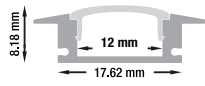
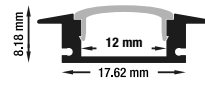
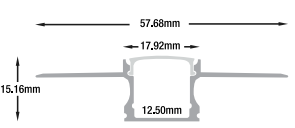
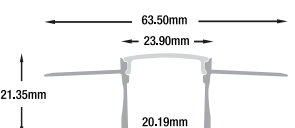
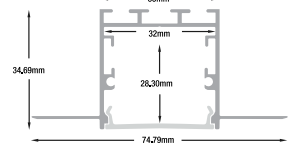
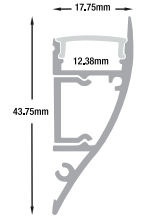
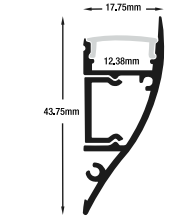
VBD-CH-WC1  SKU: 666561423599	VBD-CH-WC2  SKU: 666561423605	VBD-CH-WC3  SKU: 666561423612	VBD-CH-S1  SKU: 666561423247	VBD-CH-R3  SKU: 666561423759	VBD-CH-RF10  SKU: 666561423438		
VBD-CH-E1  SKU: 666561423483	VBD-CH-W2  SKU: 666561423452	VBD-CH-B2  SKU: 666561423230	VBD-CH-C5  SKU: 666561423568	VBD-CH-S7  SKU: 666561423322	VBD-CH-S8  SKU: 666561429348	VBD-CH-S9  SKU: 666561429355	VBD-CH-R1  SKU: 666561423735
VBD-CH-W3  SKU: 666561423469	VBD-CH-W4  SKU: 666561423476	VBD-CH-D1  SKU: 666561423643	VBD-CH-D2  SKU: 666561423650	VBD-CH-D3  SKU: 666561423667			
VBD-CH-S55  SKU: 666561429966	VBD-CH-S55B  SKU: 666561429973	VBD-CH-D4  SKU: 666561423674	VBD-CH-D5  SKU: 666561423681	VBD-CH-D6  SKU: 666561423698			
VBD-CH-RS5  SKU: 666561428631	VBD-CH-RS5B  SKU: 666561428648	VBD-CH-D7  SKU: 666561423704	VBD-CH-D8  SKU: 666561423711	VBD-CH-D9  SKU: 666561423728			
VBD-CH-M1  SKU: 666561423773	VBD-CH-M1B  SKU: 666561431013	Note: To avoid a dark spot on the sides of these channels (RF10, RF6, RF8, R3, S1, R3) we recommend installing more than one Run LED Strip. For more details please contact us at sales@veroboard.com					

RECOMMENDED LED POWER SUPPLIES (Sold Separately)

For more options and varieties, please visit our website: www.veroboard.com

Constant Voltage Dimmable LED Drivers (5 in 1), Triac/Phase, 0-10V, 1-10V, Potentiometer, 10V PWM 5 in 1 Dimming



Model No.	Input Voltage	Output Voltage	Wattage	IP Rating	Class	Max. Strip Length	SKU#
VBD-012-030C2DM5i1	100-277V	12V	30W	IP67	Class 2	8ft	666561425999
VBD-012-060C2DM5i1	100-277V	12V	60W	IP67	Class 2	16ft	666561426002
VBD-012-100C2DM5i1	100-277V	12V	100W	IP65	Type HL	26.6ft	666561428426
VBD-012-150C2DM5i1	100-277V	12V	150W	IP65	Type HL	40ft	666561428433
VBD-012-180C2DM5i1	100-277V	12V	180W (3x60W)	IP67	Class 2	48ft	666561426019
VBD-012-300C2DM5i1	100-277V	12V	300W (5x60W)	IP67	Class 2	80ft	666561426026

For more information about our products and services, please visit our website: www.veroboard.com

Constant Voltage Triac LED Drivers forward Phase, Magnetic Low Voltage & Triac Dimmers



Model No.	Input Voltage	Output Voltage	Wattage	IP Rating	Class	Max. Strip Length	SKU#
VBD-012-024DM	100-130V	12V	24W	IP20	Class 2	6.4ft	666561415761
VBD-012-048DM	100-130V	12V	48W	IP20	Class 2	12.8ft	666561415754
VBD-012-060DM	100-130V	12V	60W	IP20	Class 2	16ft	666561415747
VBD-012-096DM	100-130V	12V	96W	IP67	-	25.6ft	666561415730
VBD-012-150DM	100-130V	12V	150W	IP67	-	40ft	666561415723
VBD-012-200DM	100-130V	12V	200W	IP67	-	53.3ft	666561415716
VBD-012-300VTHWJ	100-277V	12V	300W	IP65	-	80ft	666561419790

Dali Dimming Constant Voltage



Model No.	Input Voltage	Output Voltage	Wattage	IP Rating	Class	Max. Strip Length	SKU#
VBD-012-030DD	100-265V AC	12V	30W	IP20	Class 2	8ft	666561427290
VBD-012-060DD	100-265V AC	12V	60W	IP65	Class 2	16ft	666561427313
VBD-012-096DD	100-265V AC	12V	96W	IP65	-----	25.6ft	666561427337
VBD-012-150DD	100-265V AC	12V	150W	IP65	-----	40ft	666561427351

Plug-in Drivers



Model No.	Input Voltage	Output Voltage	Wattage	IP Rating	Class	Max. Strip Length	SKU#
VBDA-012-012P1J	100-240V AC	12V	12W	IP20	Class 2	3.2ft	666561428945
VBDA-012-024P1J	100-240V AC	12V	24W	IP20	Class 2	6.4ft	666561428952
VBDA-012-036P1J	100-240V AC	12V	36W	IP20	Class 2	9.6ft	666561428976
VBDA-012-060P1J	100-240V AC	12V	60W	IP20	-----	16ft	666561428990

Notes: _____

Disclaimer:

The data and information contained in this specification sheet are subject to change without notice; the ratings supplied are provided based on the product manufacturer. The information contained in this specification sheet should not be considered a warranty, expressed or implied, including, but not limited to, a warranty of merchantability or fitness for a particular purpose. In no event shall Veroboard be liable for any incidental or consequential damages resulting from the use, misuse, or inability to use the product. This exclusion applies regardless of whether such damages are sought based on breach of warranty, breach of contract, negligence, strict liability in tort, or any other legal theory.

For more information about our products and services, please visit our website: www.veroboard.com