

VEROBOARD®

LED Type: VBDFS-3528-5000-120-24-WP
Colour: 5000K

	Wattage	Brightness
Per Foot	3W/ft	256Lm/ft
Per Meter	9.6W/m	840Lm/m



Job Name: _____

Distributor: _____

Type: _____



666561425289

DESCRIPTION

Flexible 10 mm wide linear LED strip. Available in 10 meter (32.8 feet) rolls that can be cut every 3 LEDs (50 mm or 2 in). The LED Strip lights are manufactured with high-quality materials and designed for professional lighting. Every strip light begins with a heavy-duty dual-core copper printed circuit board (PC Board), it is then soldered with an array of chips and color options. They can be cut to any size (marked interval points) and rejoined by soldering.

DIMENSIONS

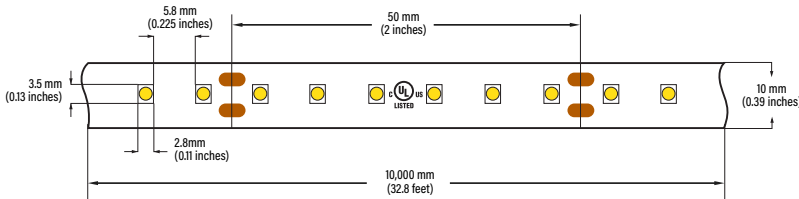

SPECIFICATIONS

Model:	VBDFS-3528-5000-120-24-WP
Color Temperature:	5000K (Daylight)
LED Type:	3528 SMD
LED Qty:	120 LEDs per meter
LM/LED:	7-8 Lm per LED
Input Voltage (VF):	24V DC
Power:	9.6W Per meter (3W/ft)
Brightness:	840Lm/meter (256Lm/ft)
Lifespan:	>50,000 hours
PCB:	4oz PCB, Double-side, white colour 10mm width
IP Rating:	IP68 [Weatherproof]
Rendering Index (Ra):	CRI>95
Beam Angle:	120°
Dimmable:	Yes
Cut Size:	Every 6 LED chips (2")
Operating Temperature:	-15°C to +40°C
Dimensions:	10,000 x 10 x 5.8mm (393.6" x 0.39" x 0.22")
Certificates:	cUL/RoHs
Roll Length:	10 meter roll (32.8ft)



Accessories (Sold Separately)

Model: 3W-2C-SC
 SKU: 666561406288

Model: 2W-2C-SC
 SKU: 666561406295

Model: 3W-JB-M686
 SKU: 666561434182

3 Way Outdoor
 Screw Type Connector
 2 Contact

2 Way Outdoor
 Screw Type Connector
 2 Contact



ORDERING GUIDE

Example part number: **VBDFS - 3528 - 5000 - 120 - 24 - WP**

MODEL	SERIES	COLOUR	LEDS/METER	VOLTAGE	WP	LENGTH
VBDFS	3528	5000K	120	24V	WP	XXXX

Custom Length
 Full Roll
 (10 Meter)

For more information about our products and services, please visit our website: www.veroboard.com

Light Measurement Report

Print date: 2023-05-02

Measurement date and time: 2023-05-02 12:01:55 PM – Measurement no. VFR-230502-0195-MS

Luminous Intensity diagram

Unit: 0-100% of peak intensity

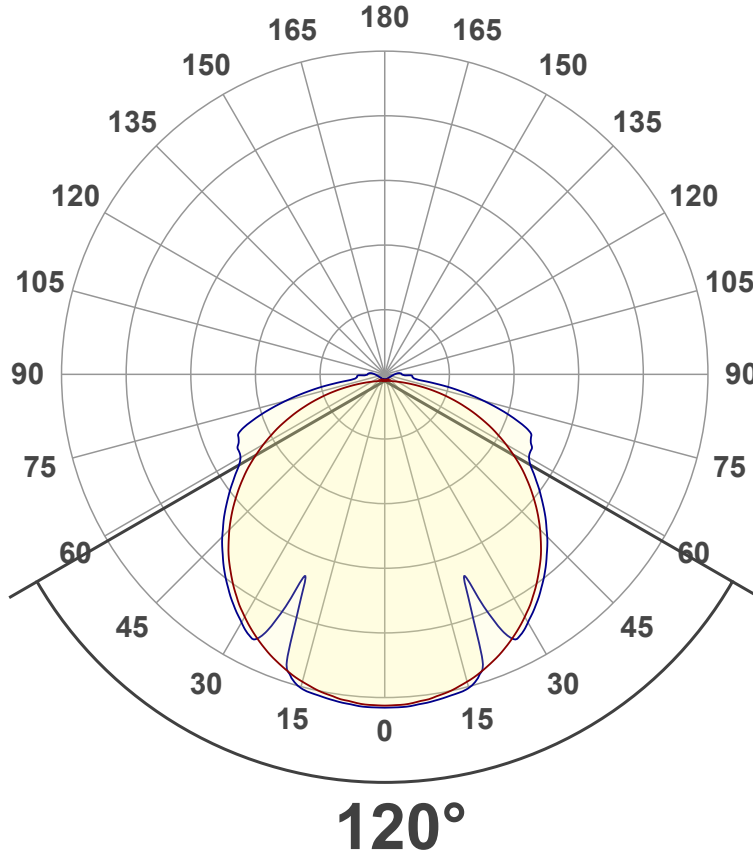

Main Values

Lumen Up% / Down%	4.13% / 95.87%
Peak Intensity	16.1 cd
Beam Angle (50%)	120°
Beam Angle (90%)	132.5°
Beam Angle (10%)	116.5°

Cut-off Angle

Average 2,5%	213.4°
--------------	--------

Field Angle

Average 10%	174.9°
-------------	--------

Intensity Ratio

In 120° cone	69.0%
In 90° cone	45.8%

C000-C180
C090-C270

Linear distribution diagram - Intensity (candela) vs γ -angle

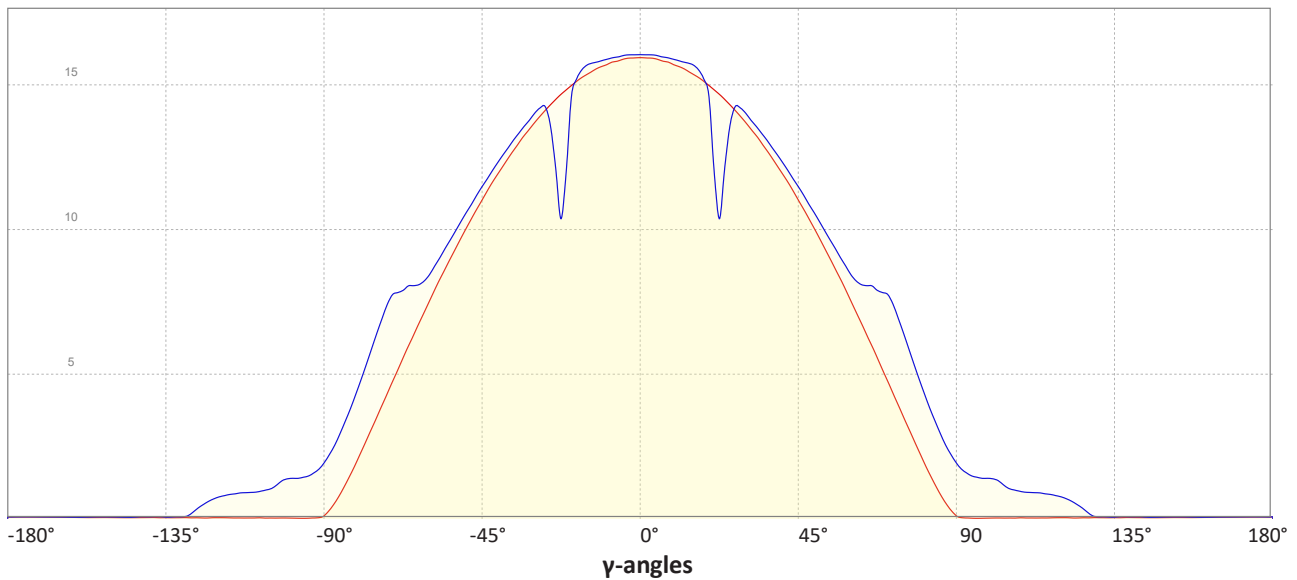

Light Measurement Report

Print date: 2023-05-02

Measurement date and time: 2023-05-02 12:01:55 PM – Measurement no. VFR-230502-0195-MS

Color details

Correlated Color Temperature, Target CCT = 5000 K
 Correlated Color Temperature, Measured CCT = 4978 K
 Color Rendering Index CRI 96.7
 Color Rendering Index, R9 (red component) R9 = 98.1
 Color Rendering TM30-18 R_f 92.3 – R_g 99.4
 Color Quality Scale CQS = 93.7

MacAdam Steps SDCM = 2.6
 Color coordinates CIE 1931 (x;y) = (0.345;0.352)
 Color coordinate CIEs 1960 (u';v') = (0.211;0.323)
 Color deviation from BBL Duv = 0.0010
 Color coordinate CIEs 1976 (CIELUV) (u'';v'') = (0.211;0.211)

CIE 1931

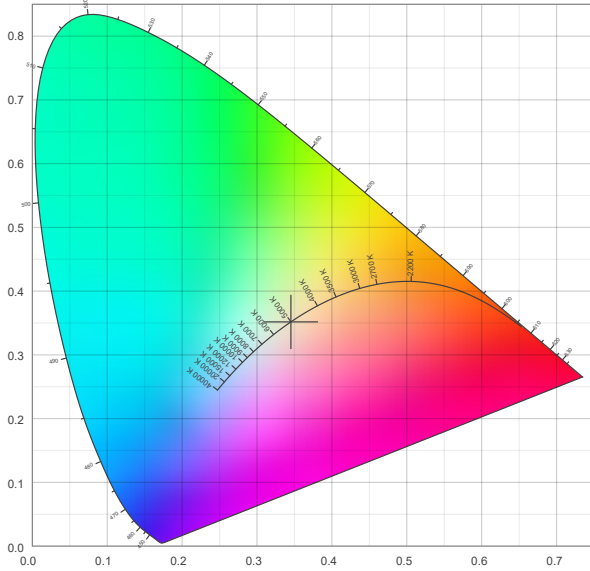

CIE 1931 – zoomed on Planckian locus

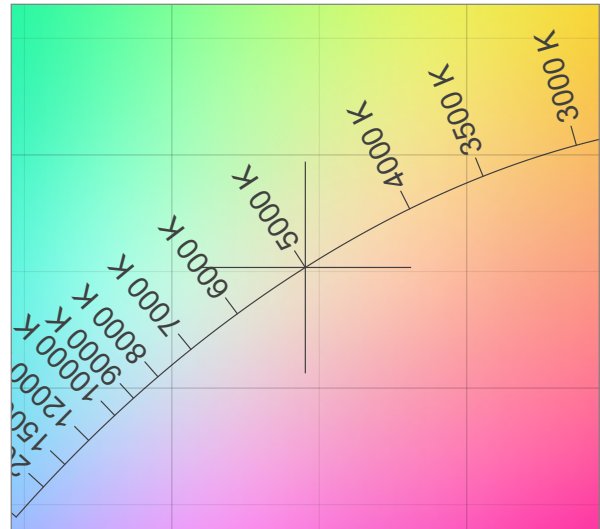

Color Rendering Index per reference color (CIE 1995)

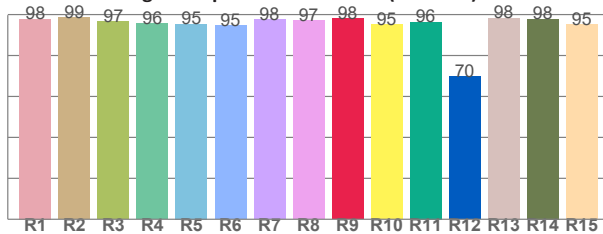

CRI R values, only R1-R8 are used to calculate final CRI value

R1	R2	R3	R4	R5	R6	R7	R8	R9	R10	R11	R12	R13	R14	R15
97.8	98.7	96.5	95.7	95.3	94.7	97.5	97.1	98.1	95.0	96.3	69.7	98.4	97.8	95.3

Spectral power distribution (SPD) / W/nm – 0-100%

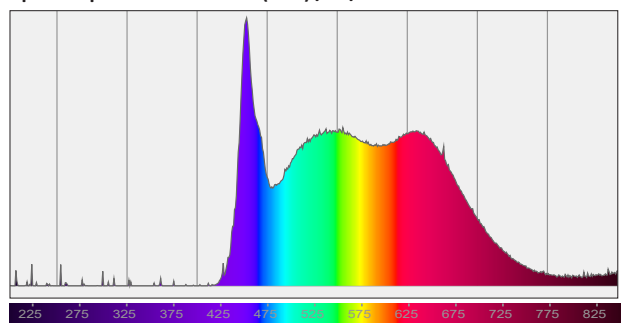

TM30-18 R_f-values per hue bin

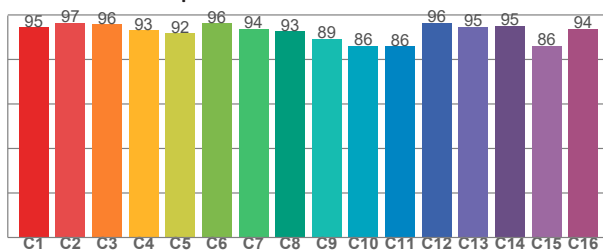

TM30 C values, 16 binned values out of total of 99 C values

C1	C2	C3	C4	C5	C6	C7	C8	C9	C10	C11	C12	C13	C14	C15	C16
94.5	96.6	95.9	93.0	91.8	96.2	93.8	92.8	89.2	86.3	86.0	96.4	94.6	95.0	86.1	93.7

Color Quality Scale by reference color

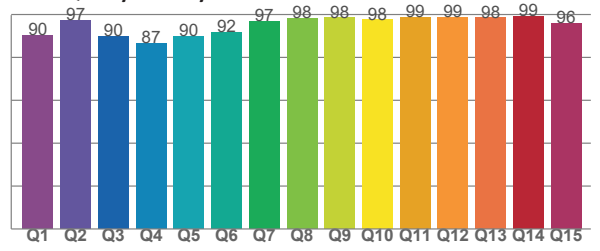

CQS Q values

Q1	Q2	Q3	Q4	Q5	Q6	Q7	Q8	Q9	Q10	Q11	Q12	Q13	Q14	Q15
90.4	97.4	89.7	86.7	89.9	91.8	96.8	98.2	98.4	97.6	98.7	98.6	98.5	99.1	95.8

Light Measurement Report

Print date: 2023-05-02

Measurement date and time: 2023-05-02 12:01:55 PM – Measurement no. VFR-230502-0195-MS

Beam Details

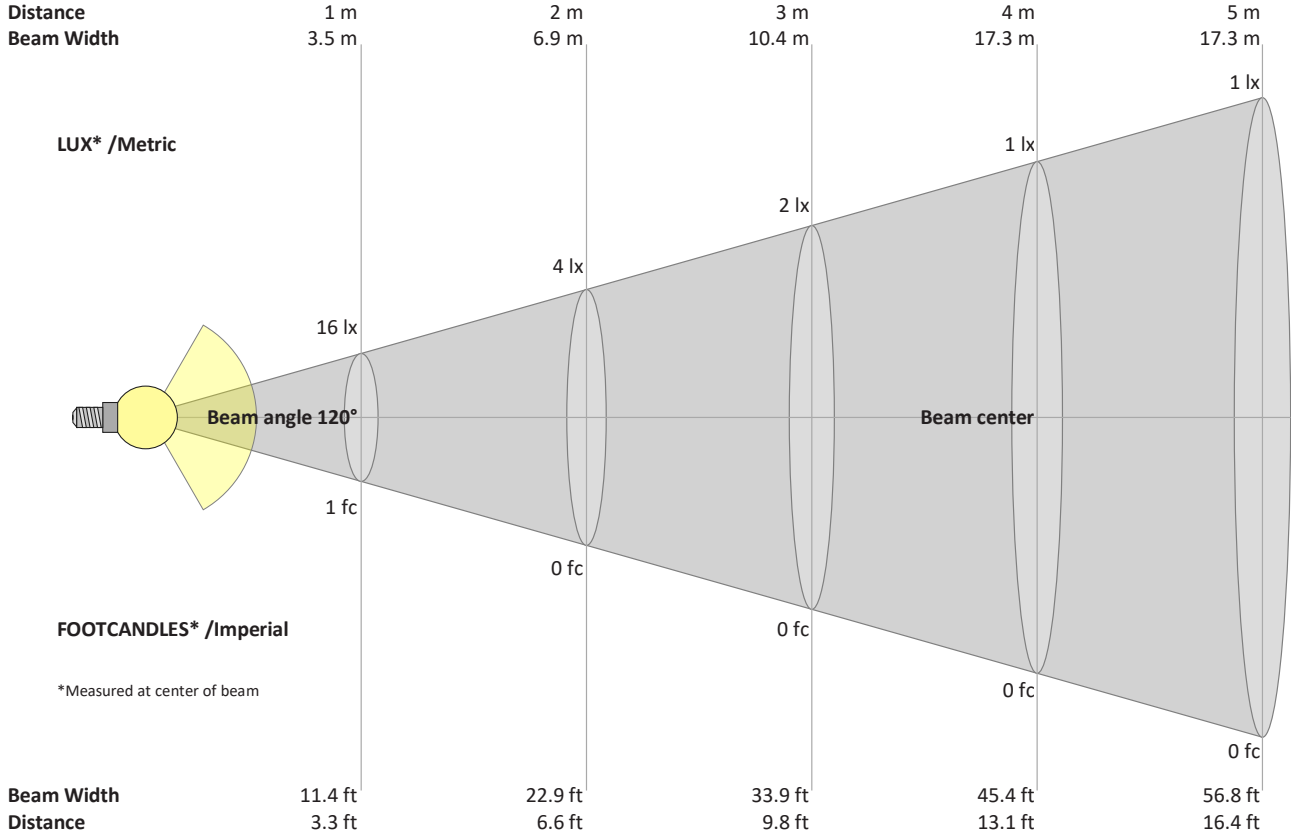

Beam intensities from 1 – 20 m

1	2	3	4	5	6	7	8	9	10	11	12	13	14	15	16	17	18	19	20	m	
3.3	6.6	9.8	13.1	16.4	19.7	23	26.2	29.5	32.8	36.1	39.4	42.7	45.9	49.2	52.5	55.8	59.1	62.3	65.6	ft	
16	4	2	1	1	0	0	0	0	0	0	0	0	0	0	0	0	0	0	0	0	lux
1.5	0.4	0.2	0.1	0.1	0	0	0	0	0	0	0	0	0	0	0	0	0	0	0	0	fc

Intensities in 0° c-plane

0°	5°	10°	15°	20°	25°	30°	35°	40°	45°	50°	55°	60°	65°	70°	75°	80°	85°	90°	95°	y	
16.0	15.9	15.7	15.4	14.9	14.4	13.7	12.9	12.0	11.0	9.9	8.8	7.5	6.2	4.9	3.5	2.2	0.9	0.1	0.0	0.0	cd
100%	99%	98%	96%	93%	90%	86%	81%	75%	69%	62%	55%	47%	39%	30%	22%	14%	6%	1%	0%	0%	of 0°val

Intensities in 90° c-plane

0°	5°	10°	15°	20°	25°	30°	35°	40°	45°	50°	55°	60°	65°	70°	75°	80°	85°	90°	95°	y	
16.0	16.0	15.9	15.7	13.8	13.1	14.0	13.3	12.4	11.5	10.5	9.5	8.4	8.1	7.8	6.4	4.6	3.1	1.9	1.5	0.0	cd
100%	100%	99%	98%	87%	82%	88%	83%	78%	72%	66%	59%	53%	50%	49%	40%	29%	19%	12%	9%	0%	of 0°val

Intensities in 180° c-plane

0°	5°	10°	15°	20°	25°	30°	35°	40°	45°	50°	55°	60°	65°	70°	75°	80°	85°	90°	95°	y	
16.0	15.9	15.7	15.4	14.9	14.4	13.7	12.9	12.0	11.0	9.9	8.8	7.5	6.2	4.9	3.5	2.2	0.9	0.1	0.0	0.0	cd
100%	99%	98%	96%	93%	90%	86%	81%	75%	69%	62%	55%	47%	39%	30%	22%	14%	6%	1%	0%	0%	of 0°val

Intensities in 270° c-plane

0°	5°	10°	15°	20°	25°	30°	35°	40°	45°	50°	55°	60°	65°	70°	75°	80°	85°	90°	95°	y	
16.0	16.0	15.9	15.7	13.8	13.1	14.0	13.3	12.4	11.5	10.5	9.5	8.4	8.1	7.8	6.4	4.6	3.1	1.9	1.5	0.0	cd
100%	100%	99%	98%	87%	82%	88%	83%	78%	72%	66%	59%	53%	50%	49%	40%	29%	19%	12%	9%	0%	of 0°val

CUSTOM ORDERING GUIDE ✂

Single Run (Straight Run): The below ordering guide will be used for single run LED strip.

- **PFL:** Power Feed Length
- **SL:** Strip Length

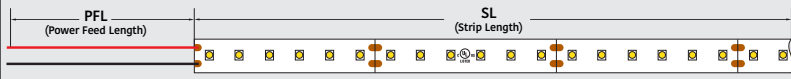

Example: 2 (QTY) x 36" (PFL) - 84" (SL) x -

CUSTOM ORDERING GUIDE ✂

Joiner: LED strip lights need joiners if they are used for curve applications such as corner side, behind a mirror, etc.

- **PFL:** Power Feed Length
- **SL:** Strip Length
- **JL:** Joiner Length

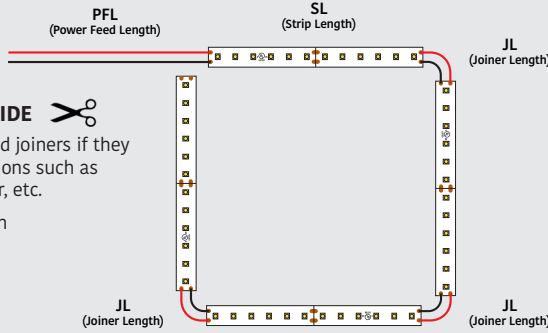

x - - - - - - -

Example: 1 (QTY) x 12" (PFL) - 46" (SL) - 1" (JL) - 36" (SL) - 1" (JL) - 46" (SL) - 1" (JL) - 36" (SL)

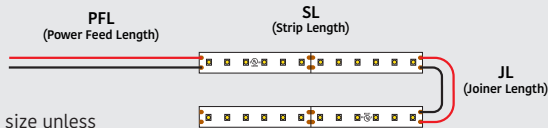

Note: Joiners will be 1-inch size unless customers require a specific size.

x - - -

Example: 2 (QTY) x 24" (PFL) - 52" (SL) - 1" (JL) - 52" (SL)

RECOMMENDED LED ALUMINUM CHANNELS

(Sold Separately)

VBD-CH-S4 15.5mm x 12mm x 17.5mm	VBD-CH-S4B 15.5mm x 12mm x 17.5mm	VBD-CH-S6 10.6mm x 20.15mm x 23.44mm
SKU: 666561423278	SKU: 666561423285	SKU: 666561423315
VBD-CH-S5 8mm x 13mm x 17mm	VBD-CH-S5B 8mm x 13mm x 17mm	VBD-CH-B1 6.14mm x 13.89mm x 18.77mm
SKU: 666561423292	SKU: 666561423308	SKU: 666561423360
VBD-CH-C2 18.5mm x 14mm x 18.5mm	VBD-CH-C2B 18.5mm x 14mm x 18.5mm	VBD-CH-RF4 23.4mm x 18.6mm
SKU: 666561423506	SKU: 666561423513	SKU: 666561423377
VBD-CH-RF1 12.5mm x 15mm x 17mm	VBD-CH-RF1B 12.5mm x 15mm x 17mm	VBD-CH-C1 25.68mm x 15.07mm x 21.19mm
SKU: 666561423339	SKU: 666561423346	SKU: 666561423490
VBD-CH-C3 30mm x 20mm x 30mm	VBD-CH-C3B 30mm x 20mm x 30mm	VBD-CH-W1 26.16mm x 12mm x 21.43mm
SKU: 666561423520	SKU: 666561423537	SKU: 666561423445
VBD-CH-RF7 32.16mm x 75mm x 90mm	VBD-CH-RF8 32mm x 70.15mm x 75mm	VBD-CH-S2 9.88mm x 56.75mm x 17.29mm x 13.22mm
SKU: 666561423407	SKU: 666561423414	SKU: 666561423254
VBD-CH-WC4 45.50mm x 85mm x 37.85mm	VBD-CH-WC5 39mm x 42.50mm x 53.84mm x 102mm	VBD-CH-ST2 27mm x 65mm x 13mm
SKU: 666561423629	SKU: 666561423636	SKU: 666561423582
VBD-CH-S3 55.38mm x 13.56mm x 7.96mm	VBD-CH-RF6 31.90mm x 46.42mm x 23.80mm x 50.20mm	VBD-CH-RF5 32mm x 30.84mm x 35.65mm x 34.79mm
SKU: 666561423261	SKU: 666561423391	SKU: 666561423384
VBD-CH-C5 20mm x 13.33mm x 14.60mm	VBD-CH-RF2 11mm x 12.15mm x 21.45mm	VBD-CH-R2 25.95mm x 22.94mm x 17.46mm x 21.84mm
SKU: 666561423568	SKU: 666561423353	SKU: 666561423742
VBD-CH-R2B 25.95mm x 22.94mm x 17.46mm x 21.84mm	VBD-CH-D10 136mm x 13.66mm x 12mm x 19mm	SKU: 666561428280
SKU: 666561428280	SKU: 666561420023	

For more information about our products and services, please visit our website: www.veroboard.com

VBD-CH-WC1 SKU: 666561423599	VBD-CH-WC2 SKU: 666561423605	VBD-CH-WC3 SKU: 666561423612	VBD-CH-S1 SKU: 666561423247	VBD-CH-R3 SKU: 666561423759	VBD-CH-RF10 SKU: 666561423438
VBD-CH-E1 SKU: 666561423483	VBD-CH-W2 SKU: 666561423452	VBD-CH-S7 SKU: 666561423322	VBD-CH-R1 SKU: 666561423735	VBD-CH-D1 SKU: 666561423643	VBD-CH-D5 SKU: 666561423681
VBD-CH-W3 SKU: 666561423469	VBD-CH-W4 SKU: 666561423476	VBD-CH-D7 SKU: 666561423704	VBD-CH-D8 SKU: 666561423711	VBD-CH-D9 SKU: 666561423728	
VBD-CH-S55 SKU: 666561429966	VBD-CH-S55B SKU: 666561429973	VBD-CH-M1 SKU: 666561423773	VBD-CH-M1B SKU: 666561431013		
VBD-CH-RS5 SKU: 666561428631	VBD-CH-RS5B SKU: 666561428648				

Note: To avoid a dark spot on the sides of these channels (RF10, RF6, RF8, R3, S1, R3) we recommend installing more than one Run LED Strip. For more details please contact us at: sales@veroboard.com

RECOMMENDED LED POWER SUPPLIES (Sold Separately)

For more options and varieties, please visit our website: www.veroboard.com

Constant Voltage Dimmable LED Drivers (5 in 1), Triac/Phase, 0-10V, 1-10V, Potentiometer, 10V PWM 5 in 1 Dimming



Model No.	Input Voltage	Output Voltage	Wattage	IP Rating	Class	Max. Strip Length	SKU#
VBD-024-030C2DM5i1	100-277V	24V	30W	IP67	Class 2	8ft	666561426033
VBD-024-060C2DM5i1	100-277V	24V	60W	IP67	Class 2	16ft	666561426040
VBD-024-080C2DM5i1	100-277V	24V	80W	IP67	Class 2	21.4ft	666561426088
VBD-024-096C2DM5i1	100-277V	24V	96W	IP67	Class 2	25.6ft	666561426057
VBD-024-192C2DM5i1	100-277V	24V	192W (2x96W)	IP67	Class 2	51.2ft	666561426064
VBD-024-288C2DM5i1	100-277V	24V	288W (3x96W)	IP67	Class 2	76.8ft	666561426071

For more information about our products and services, please visit our website: www.veroboard.com

Constant Voltage Triac LED Drivers forward Phase, Magnetic Low Voltage & Triac Dimmers



Model No.	Input Voltage	Output Voltage	Wattage	IP Rating	Class	Max. Strip Length	SKU#
VBD-024-024DM	100-130V	24V	24W	IP20	Class 2	6.4ft	666561415839
VBD-024-048DM	100-130V	24V	48W	IP20	Class 2	12.8ft	666561415822
VBD-024-060DM	100-130V	24V	60W	IP20	Class 2	16ft	666561415815
VBD-024-096DM	100-130V	24V	96W	IP67	Class 2	25.6ft	666561415808
VBD-024-150DM	100-130V	24V	150W	IP67	-	40ft	666561415792
VBD-024-200DM	100-130V	24V	200W	IP67	-	53.3ft	666561415785
VBD-024-300VTHWJ	100-277V	24V	300W	IP65	-	80ft	666561419806

Dali Dimming Constant Voltage



Model No.	Input Voltage	Output Voltage	Wattage	IP Rating	Class	Max. Strip Length	SKU#
VBD-024-030DD	100-265V AC	24V	30W	IP20	Class 2	8ft	666561427306
VBD-024-060DD	100-265V AC	24V	60W	IP65	Class 2	16ft	666561427320
VBD-024-096DD	100-265V AC	24V	96W	IP65	Class 2	25.6ft	666561427344
VBD-024-150DD	100-265V AC	24V	150W	IP65	-----	40ft	666561427368
VBD-024-200DD	100-265V AC	24V	200W	IP65	-----	53.3ft	666561427375

Plug-in Drivers



Model No.	Input Voltage	Output Voltage	Wattage	IP Rating	Class	Max. Strip Length	SKU#
VBDA-024-024P1J	100-240V AC	24V	24W	IP20	Class 2	6.4ft	666561428969
VBDA-024-036P1J	100-240V AC	24V	36W	IP20	Class 2	9.6ft	666561428983
VBDA-024-060P1J	100-240V AC	24V	60W	IP20	Class 2	16ft	666561429003

Notes: _____

Disclaimer:

The data and information contained in this specification sheet are subject to change without notice; the ratings supplied are provided based on the product manufacturer. The information contained in this specification sheet should not be considered a warranty, expressed or implied, including, but not limited to, a warranty of merchantability or fitness for a particular purpose. In no event shall Veroboard be liable for any incidental or consequential damages resulting from the use, misuse, or inability to use the product. This exclusion applies regardless of whether such damages are sought based on breach of warranty, breach of contract, negligence, strict liability in tort, or any other legal theory.

For more information about our products and services, please visit our website: www.veroboard.com