

MODEL: VBUN-2R25-12V Shine Series

This Shine Series LED Cabinet Lights has a lightweight aluminum housing that can be either surface mounted or recessed, making it ideal for a variety of commercial, industrial and residential applications.

The downlight uses 2.5 watts of power, operating on 12V DC, and is simple to install in a 56 mm (2.18 in) hole size for recessed application or can be directly surface-mounted based on the desired application. Its modern, sleek design is available in six color finish. The fixture comes in different color temperatures from amber white, soft white, and warm white tone for soothing light applications to natural white, daylight for offices, and other commercial working spaces. They work with a 12V power supply with low power consumption and high energy efficiency.



PART NUMBER BUILDER / ORDERING GUIDE				
Example part number: VBUN-2R25-12V - Shine Gold - 2400K				
MODEL	FIXTURE COLOR		COLOR TEMPERATURE	
VBUN-2R25-12V				
	Shine White	Shine Black	2400K	3500K
	Shine Silver Grey	Shine Gold	2700K	4000K
	Shine Polished Chrome		3000K	5000K

SPECIFICATIONS

Model No.	VBUN-2R25-12V
LED Type	3 x 5730 SMD
Rendering Index	CRI>90
Input Voltage	12V DC
Power	2.5W
Brightness	230-250 Lm
Lifespan	>50,000 hours
Color Temperature	2400K, 2700K, 3000K, 3500K, 4000K, 5000K
Fixture Color	Silver Grey, White, Black, Polished Chrome, Gold
Fixture Material	Aluminum
Diffuser Material	Polycarbonate Plastic
IP Rating	IP20
Dimmable	Yes
Beam Angle	120°
Installation Type	Surface Mount and Flush Mount Installation
Operating Temperature	-15°C to +40°C
Flush Mount Installation Cut-Size	56 mm (2.18 in)
Diameter	62 mm (2.43 in)
Depth	8 mm (0.31 in)
Certificates	ETL

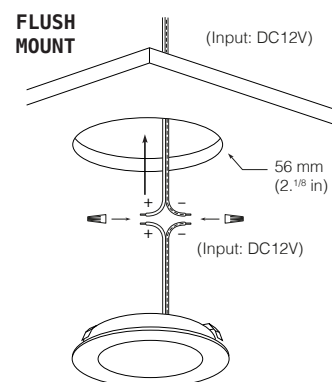
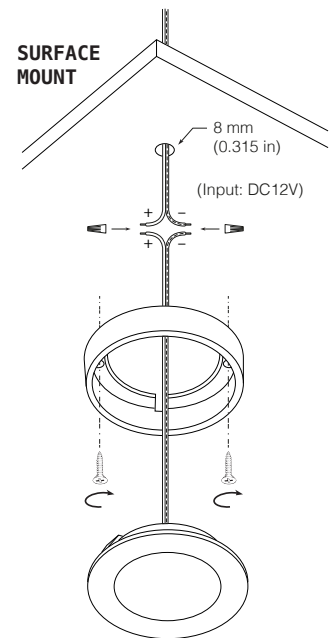

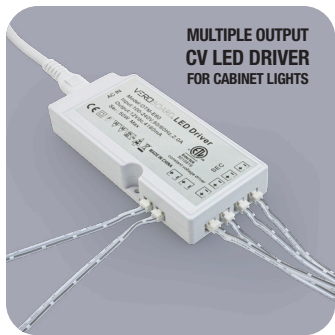

**MULTIPLE OUTPUT
CV LED DRIVER
FOR CABINET LIGHTS**

OTM-E60

SKU: 666561425425

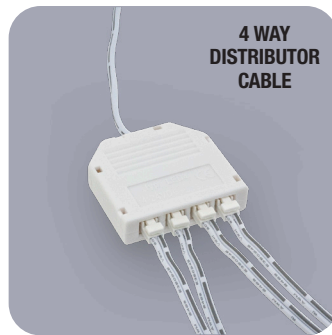

**4 WAY
DISTRIBUTOR
CABLE**

VBUN-DIS-4

SKU: 666561426118

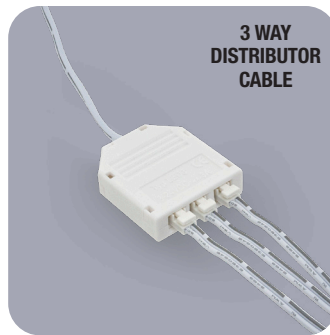

**3 WAY
DISTRIBUTOR
CABLE**

VBUN-DIS-3

SKU: 666561426101

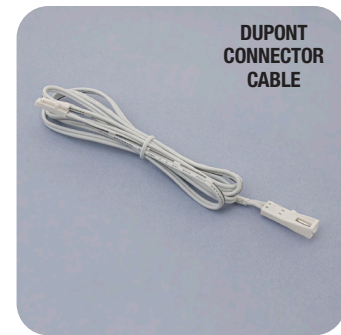

**DUPONT
CONNECTOR
CABLE**

VBD-LR-2P

SKU: 666561426248

CONSTANT VOLTAGE DIMMABLE LED DRIVERS (5 IN 1), TRIAC/PHASE, 0-10V, 1-10V, POTENTIOMETER, 10V PWM 5 IN 1 DIMMING

Model No.	Input Voltage	Output Voltage	Wattage	IP Rating	Class	SKU#
VBD-012-030C2DM5i1	100-277V	12V	30W	IP65	Class 2	666561425999
VBD-012-060C2DM5i1	100-277V	12V	60W	IP65	Class 2	666561426002
VBD-012-100DM5i1	100-277V	12V	100W	IP65	Type HL	666561428426



CONSTANT VOLTAGE TRIAC LED DRIVERS FORWARD PHASE, MAGNETIC LOW VOLTAGE & TRIAC DIMMERS

Model No.	Input Voltage	Output Voltage	Wattage	IP Rating	Class	SKU#
VBD-012-024DM	100-130V	12V	24W	IP20	Class 2	666561415761
VBD-012-048DM	100-130V	12V	48W	IP20	Class 2	666561415754
VBD-012-060DM	100-130V	12V	60W	IP20	Class 2	666561415747
VBD-012-096DM	100-130V	12V	96W	IP67	Class 2	666561415730



DALI DIMMING CONSTANT VOLTAGE

Model No.	Input Voltage	Output Voltage	Wattage	IP Rating	Class	SKU#
VBD-012-030DD	100-265V AC	12V	30W	IP20	Class 2	666561427290
VBD-012-060DD	100-265V AC	12V	60W	IP65	Class 2	666561427313
VBD-012-096DD	100-265V AC	12V	96W	IP65	-----	666561427337



PLUG-IN DRIVERS

Model No.	Input Voltage	Output Voltage	Wattage	IP Rating	Class	SKU#
VBDA-012-012P1J	100-240V AC	12V	12W	IP20	Class 2	666561428945
VBDA-012-024P1J	100-240V AC	12V	24W	IP20	Class 2	666561428952
VBDA-012-036P1J	100-240V AC	12V	36W	IP20	Class 2	666561428976
VBDA-012-060P1J	100-240V AC	12V	60W	IP20	-----	666561428990



Disclaimer:

The data and information contained in this specification sheet are subject to change without notice; the ratings supplied are provided based on the product manufacturer. The information contained in this specification sheet should not be considered a warranty, expressed or implied, including, but not limited to, a warranty of merchantability or fitness for a particular purpose. In no event shall Veroboard be liable for any incidental or consequential damages resulting from the use, misuse, or inability to use the product. This exclusion applies regardless of whether such damages are sought based on breach of warranty, breach of contract, negligence, strict liability in tort, or any other legal theory.

For more information about our products and services, please visit our website: www.veroboard.com

Light Measurement Report

Print date: 2023-01-06

Measurement date and time: 2023-01-06 9:30:49 AM – Measurement no. VFR-230106-0047-MS

Luminous Intensity diagram

Unit: 0-100% of peak intensity

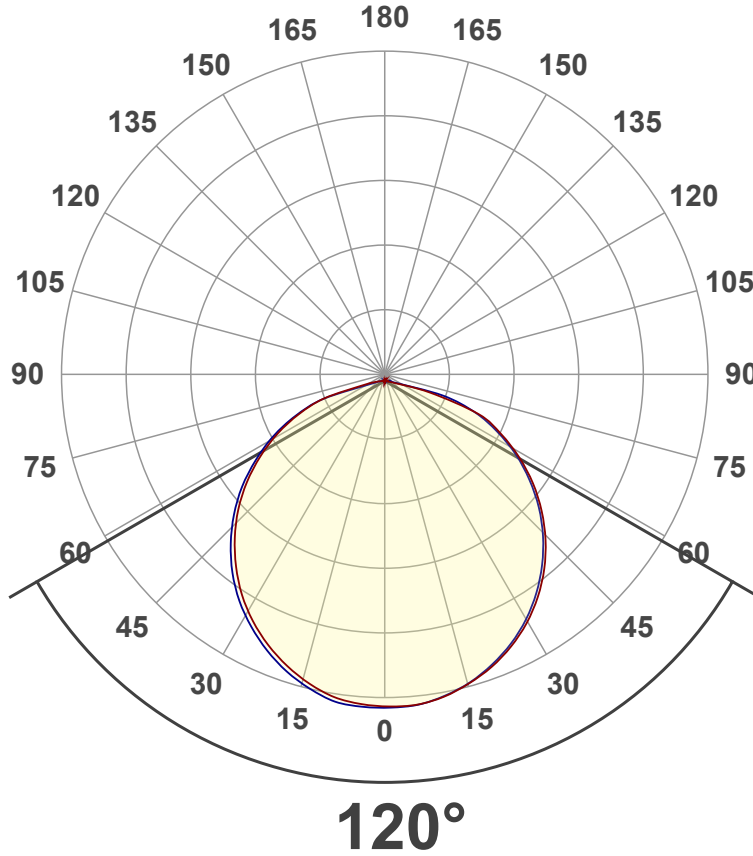

Main Values

Output (total Lumen)	230 lm
Lumen Up% / Down%	0.05% / 99.95%
Peak Intensity	80.0 cd
Beam Angle (50%)	120°
Beam Angle (90%)	115.8°
Beam Angle (10%)	115.7°

Cut-off Angle

Average 2,5%	163.2°
--------------	--------

Field Angle

Average 10%	155.5°
-------------	--------

Intensity Ratio

In 120° cone	79.9%
In 90° cone	53.8%

C000-C180
C090-C270

Linear distribution diagram - Intensity (candela) vs γ -angle

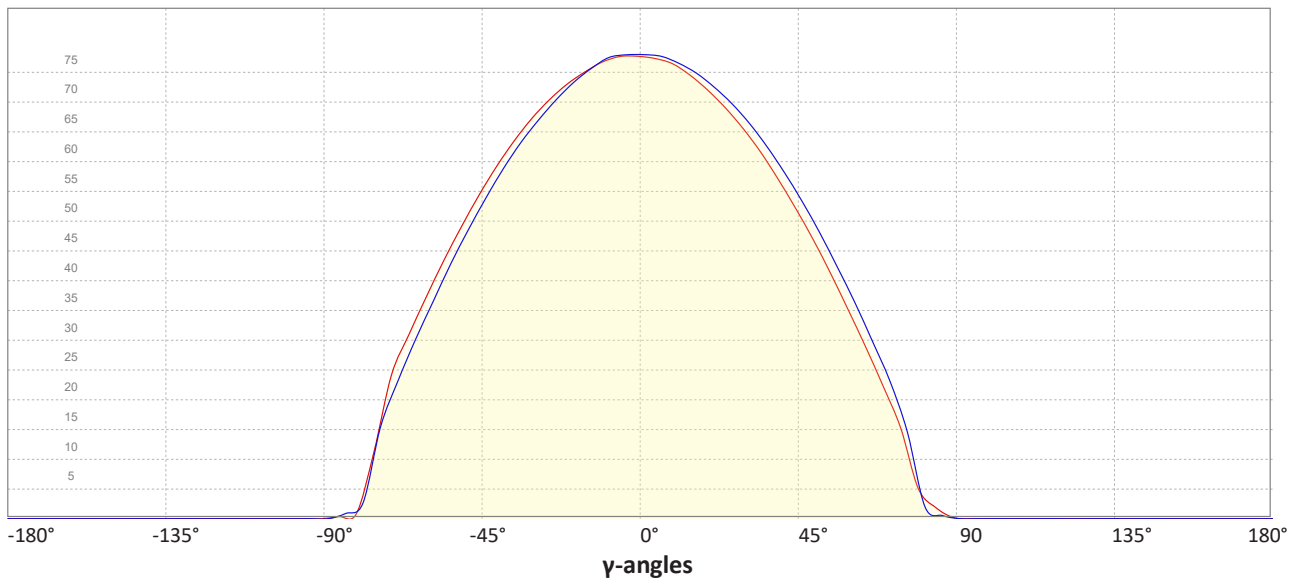

Light Measurement Report

Print date: 2023-01-06

Measurement date and time: 2023-01-06 9:30:49 AM – Measurement no. VFR-230106-0047-MS

Color details

Correlated Color Temperature, Target CCT = 3000 K
 Correlated Color Temperature, Measured CCT = 2902 K
 Color Rendering Index CRI 93.1
 Color Rendering Index, R9 (red component) R9 = 45.7
 Color Rendering TM30-18 R_f 91.2 – R_g 98.9
 Color Quality Scale CQS = 90.6

MacAdam Steps SDCM = 3.5
 Color coordinates CIE 1931 (x;y) = (0.437;0.404)
 Color coordinate CIEs 1960 (u;v) = (0.251;0.348)
 Color deviation from BBL Duv = -0.0003
 Color coordinate CIEs 1976 (CIELUV) (u';v') = (0.251;0.251)

CIE 1931

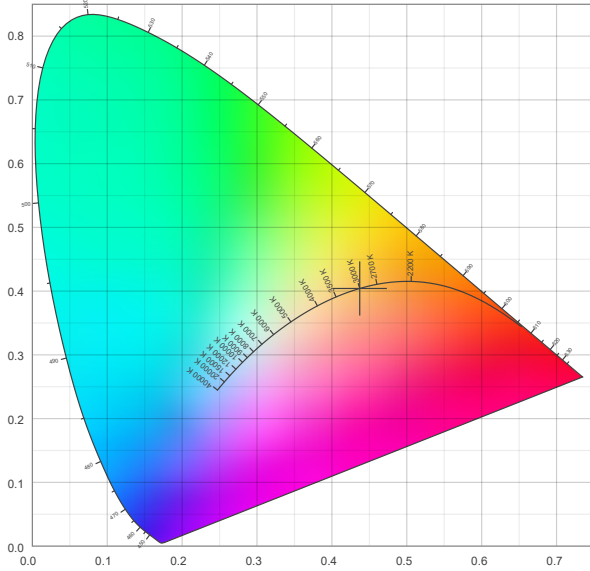

CIE 1931 – zoomed on Planckian locus

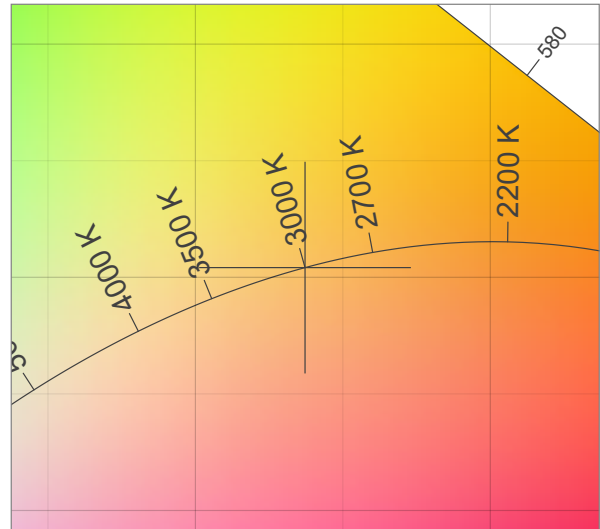

Color Rendering Index per reference color (CIE 1995)

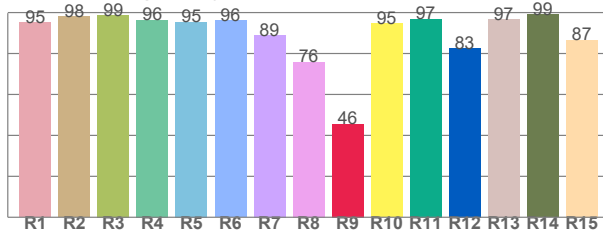

CRI R values, only R1-R8 are used to calculate final CRI value

R1	R2	R3	R4	R5	R6	R7	R8	R9	R10	R11	R12	R13	R14	R15
95.1	98.1	98.7	96.3	95.4	96.1	89.0	75.9	45.7	94.6	97.0	82.6	96.8	99.1	86.7

Spectral power distribution (SPD) / W/nm – 0-100%

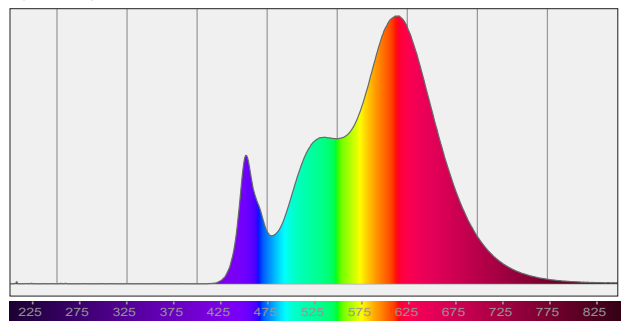

TM30-18 Rf-values per hue bin

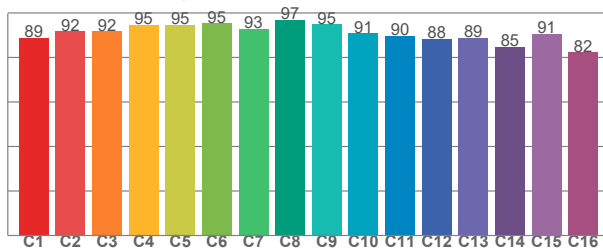

TM30 C values, 16 binned values out of total of 99 C values

C1	C2	C3	C4	C5	C6	C7	C8	C9	C10	C11	C12	C13	C14	C15	C16
88.9	91.8	91.7	94.6	94.6	95.3	92.8	96.9	94.9	90.9	89.6	88.5	88.8	84.7	90.8	82.3

Color Quality Scale by reference color

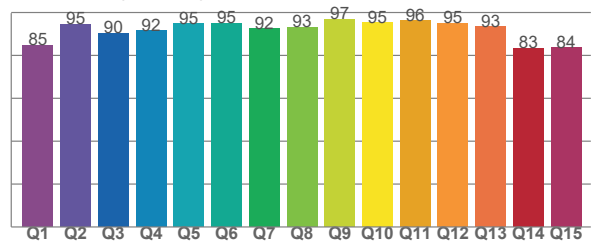

CQS Q values

Q1	Q2	Q3	Q4	Q5	Q6	Q7	Q8	Q9	Q10	Q11	Q12	Q13	Q14	Q15
84.6	94.6	90.4	91.5	94.8	95.0	92.4	93.2	96.8	95.2	96.2	95.0	93.3	83.2	83.6

Light Measurement Report

Print date: 2023-01-06

Measurement date and time: 2023-01-06 9:30:49 AM – Measurement no. VFR-230106-0047-MS

Beam Details

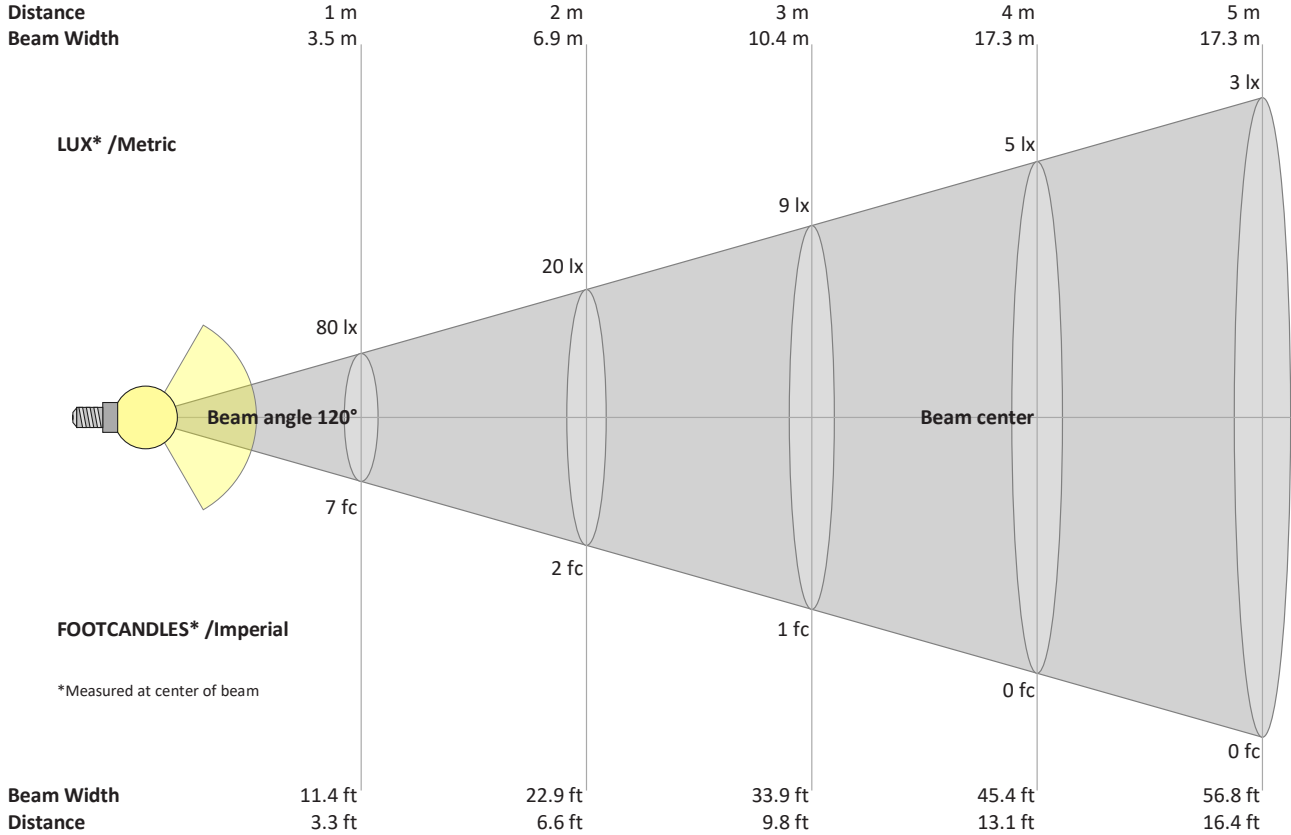

Beam intensities from 1 – 20 m

1	2	3	4	5	6	7	8	9	10	11	12	13	14	15	16	17	18	19	20	m
3.3	6.6	9.8	13.1	16.4	19.7	23	26.2	29.5	32.8	36.1	39.4	42.7	45.9	49.2	52.5	55.8	59.1	62.3	65.6	ft
80	20	9	5	3	2	2	1	1	1	1	1	0	0	0	0	0	0	0	0	lux
7.4	1.9	0.8	0.5	0.3	0.2	0.2	0.1	0.1	0.1	0.1	0.1	0	0	0	0	0	0	0	0	fc

Intensities in 0° c-plane

0°	5°	10°	15°	20°	25°	30°	35°	40°	45°	50°	55°	60°	65°	70°	75°	80°	85°	90°	95°	y
79.8	79.7	78.9	77.3	75.3	72.7	69.6	65.8	61.5	56.7	51.3	45.6	39.4	32.8	25.9	13.6	2.5	0.5	0.1	0.0	cd
100%	100%	99%	97%	94%	91%	87%	82%	77%	71%	64%	57%	49%	41%	32%	17%	3%	1%	0%	0%	of 0°val

Intensities in 90° c-plane

0°	5°	10°	15°	20°	25°	30°	35°	40°	45°	50°	55°	60°	65°	70°	75°	80°	85°	90°	95°	y
79.8	79.8	78.8	77.2	74.9	72.2	68.9	65.0	60.6	55.8	50.5	44.7	38.6	32.1	25.2	16.8	4.8	0.9	0.1	0.0	cd
100%	100%	99%	97%	94%	90%	86%	81%	76%	70%	63%	56%	48%	40%	32%	21%	6%	1%	0%	0%	of 0°val

Intensities in 180° c-plane

0°	5°	10°	15°	20°	25°	30°	35°	40°	45°	50°	55°	60°	65°	70°	75°	80°	85°	90°	95°	y
79.8	79.2	78.1	76.1	73.4	70.3	66.7	62.5	57.8	52.7	47.2	41.3	35.0	28.5	21.6	13.9	4.7	1.6	0.2	0.0	cd
100%	99%	98%	95%	92%	88%	84%	78%	72%	66%	59%	52%	44%	36%	27%	17%	6%	2%	0%	0%	of 0°val

Intensities in 270° c-plane

0°	5°	10°	15°	20°	25°	30°	35°	40°	45°	50°	55°	60°	65°	70°	75°	80°	85°	90°	95°	y
79.8	79.9	79.1	77.1	74.6	71.5	67.9	63.9	59.3	54.1	48.6	42.6	36.1	29.4	22.1	13.0	2.3	0.7	0.0	0.0	cd
100%	100%	99%	97%	93%	90%	85%	80%	74%	68%	61%	53%	45%	37%	28%	16%	3%	1%	0%	0%	of 0°val