

VEROBOARD®

Model: VBD-N1212-SF-B

Material:	Silicone
Colour:	Black
Beam Angel:	120°
Channel Length:	10m (32.8ft) Max
Channel Width:	12mm (0.47")
Channel Height:	12mm (0.47")

Job Name: _____

Distributor: _____

Type: _____

VBD-N1212-SF-B (5 meters)

SKU: 666561432683



Model: VBD-N1212-SF-B

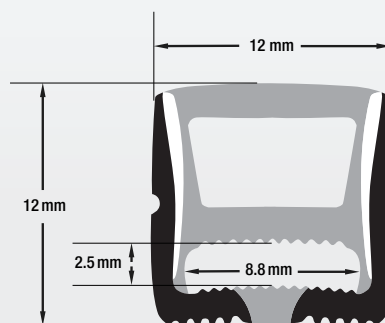

VBD-N1212-SF-B is designed to meet your needs with exceptional performance and quality. Please note that while this product is built to excel in various conditions, it is not recommended for extended exposure to strong UV rays or direct sunlight. If you intend to utilize the **VBD-N1212-SF-B** outdoors, we strongly recommend providing ample shade or protective cover to shield it from direct sunlight.

ACCESSORIES (Sold Separately)

End Caps (1 Pair/bag)	Mounting Clips (10 PCs/bag)	Flexible Clips (1 Meter)	Linear Mounting (1 Meter)
<p>Model: VBD-EN1212-B SKU: 666561432690</p>	<p>Model: VBD-CLN1212-MC SKU: 666561432720</p>	<p>Model: VBD-CLN1212-FC SKU: 666561432706</p>	<p>Model: VBD-CLN1212-LI SKU: 666561432713</p>

Ordering Guide Example: VBD-N1212-SF-B-4FT

MODEL

LENGTH (FT)

VBD-N1212-SF-B



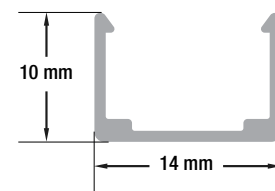
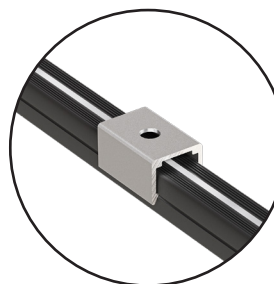

XXXX

Maximum Length **10 Meters (32.8ft)**



AVAILABLE LED STRIP LIGHTS (Sold Separately)

VOLTAGE	WATTAGE	BRIGHTNESS
24V DC	12W/m (3.5W/ft)	1475Lm/m (450Lm/ft)

MODEL	COLOUR TEMPERATURE	SKU
VBDFS-E2835-2700-168-24-NS-8	SOFT WHITE 	666561433147
VBDFS-E2835-3000-168-24-NS-8	WARM WHITE 	666561433154
VBDFS-E2835-3500-168-24-NS-8	MID-WARM WHITE 	666561433161
VBDFS-E2835-4000-168-24-NS-8	NATURAL WHITE 	666561433178
VBDFS-E2835-5000-168-24-NS-8	DAYLIGHT 	666561433185

VEROBOARD'S LED Strip Light Models Breakdown

VBDFS-E2835-2700-168-24-NS-8

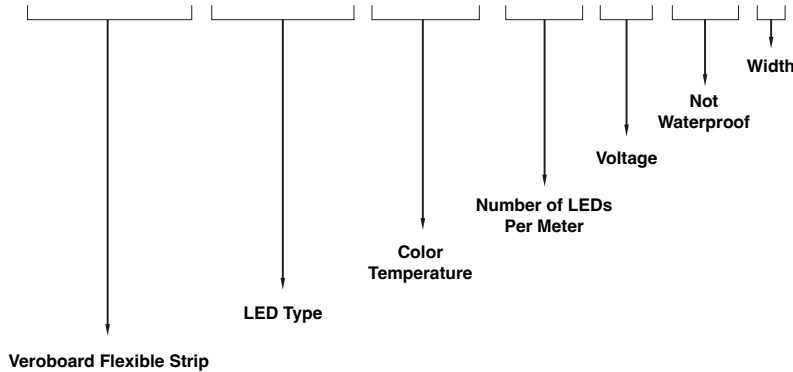

Notes:

Disclaimer:

The data and information contained in this specification sheet are subject to change without notice; the ratings supplied are provided based on the product manufacturer. The information contained in this specification sheet should not be considered a warranty, expressed or implied, including, but not limited to, a warranty of merchantability or fitness for a particular purpose. In no event shall Veroboard be liable for any incidental or consequential damages resulting from the use, misuse, or inability to use the product. This exclusion applies regardless of whether such damages are sought based on breach of warranty, breach of contract, negligence, strict liability in tort, or any other legal theory.

For more information about our products and services, please visit our website: www.veroboard.com