

4" Square Flat Panel Light

Veroboard 4-inch recessed downlight is specially designed to eliminate the glare when illuminated. It is an IC-rated fixture that comes along with a junction box LED driver. It comes in both Brushed Nickel and Black reflector trims. It has the option of choosing desired color temperature from 2700K-3000K-3500K-4000K-5000K. Moreover, the fixture comes with an FT6 rated certification cable.

SPECIFICATIONS



Engine Model No:	LED-S12W-5CCTWH-SQ
Voltage:	120V AC
Frequency:	60Hz
Power Factor (PF):	0.9
Wattage:	12W
LED Driver:	IC Rated
Color Temperature:	5CCT Selectable Color Temperature (2700K-3000K-3500K-4000K-5000K)
Dimmable:	Yes
Brightness:	800 Lumens
Rendering Index:	CRI>90
LED Type:	Integrated COB LED
Beam Angle:	110°
Engine Material:	Die-Cast Aluminum
Trim Material:	Galvanized Steel
Available Trim Colors:	Brushed Nickel, Black and Brushed Nickel <i>(Sold Separately)</i>
Installation:	Recessed/Flush Mount
IP Rating:	IP20 (Damp Locations)
Outer Dimensions:	120mm x 120mm x 32mm (4.7" x 4.7" x 1.2")
LED Driver Dimensions:	87mm x 87mm x 33mm (3.4" x 3.4" x 1.3")
Cut Size:	111mm x 111mm (4.3" x 4.3")
Package Content:	Light Fixture with IC-Rated LED Driver
Package Dimensions:	160mm x 130mm x 70mm (6.3" x 5.1" x 2.7")
Package Weight:	0.45 Kg
Certification:	FCC/ETL/Energy Star/RoHS

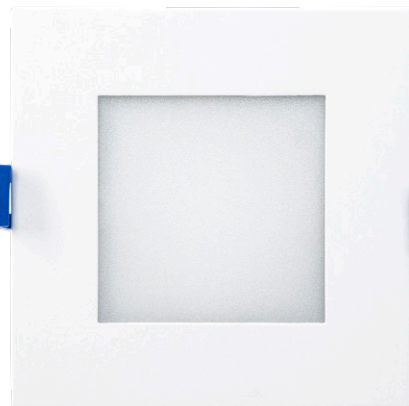

Additional trims are available for purchase separately.



Selectable Color Temperature Switch



Brushed Nickel SKU: 666561418038 **Black** SKU: 666561418021 **Black Nickel** SKU: 666561418045

Included Content:

- 4" Recessed Downlight
- Installation Instruction Manual
- IC Rated LED Driver with FT6 Rated Cable

Safety and Warning

The fixture must be wired in accordance with local electrical codes. All the installation must be done by a certified electrician. Do not modify the product, any modification may render the product unsafe and void the warranty.

Job Name: _____

Distributor: _____

Type: _____

Trim Options: White Black

Brushed Nickel Black Nickel



SKU: 666561432232

New Construction Mounting Plates

(Sold separately)

New Construction Universal Mounting Plate suitable for 3, 4, and 6-inch fixtures, with two hanger bars.
Model: **MP-UNV-346** | SKU: **666561433796**

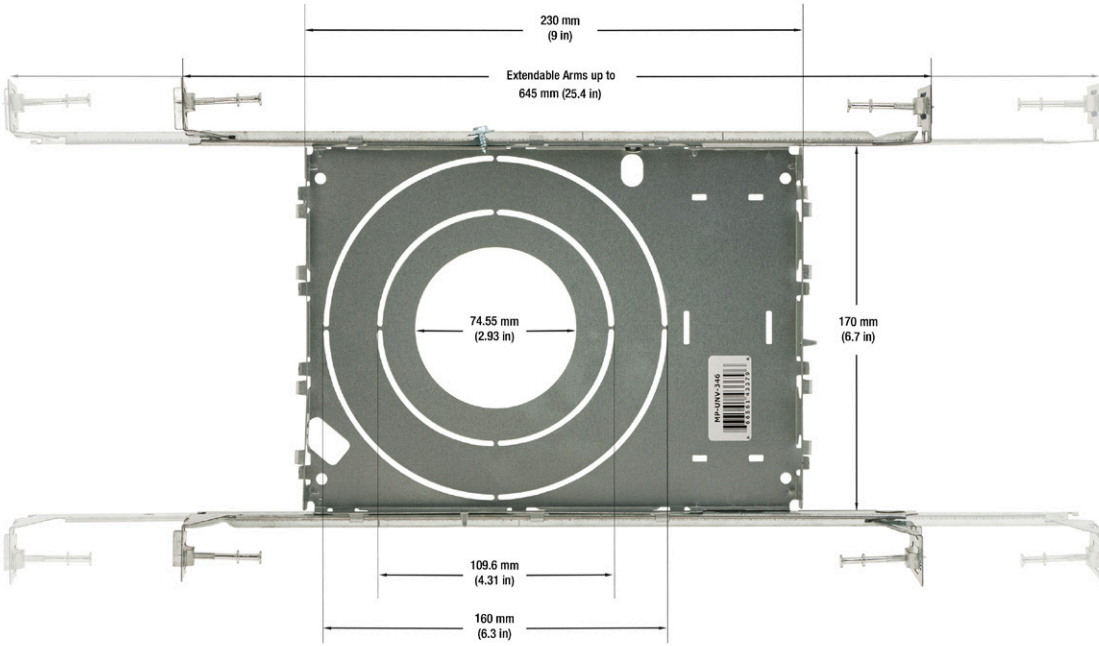
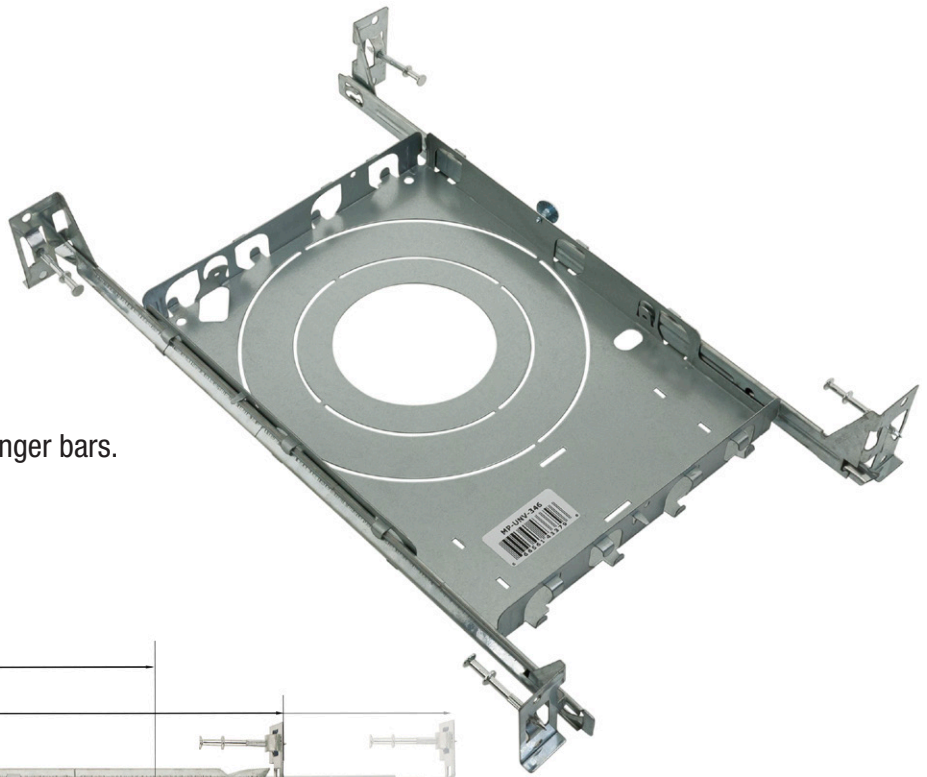

New Construction Mounting Plate suitable for 4-inch fixture without lip
Model: **MP4** | SKU: **666561433789**

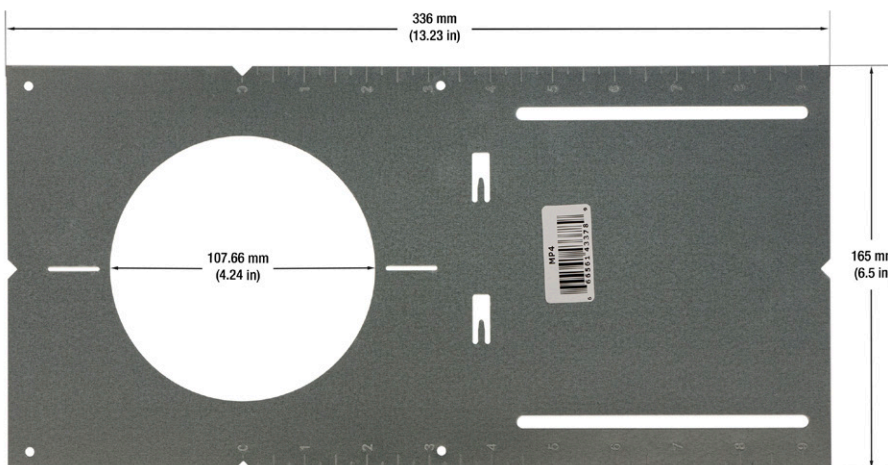
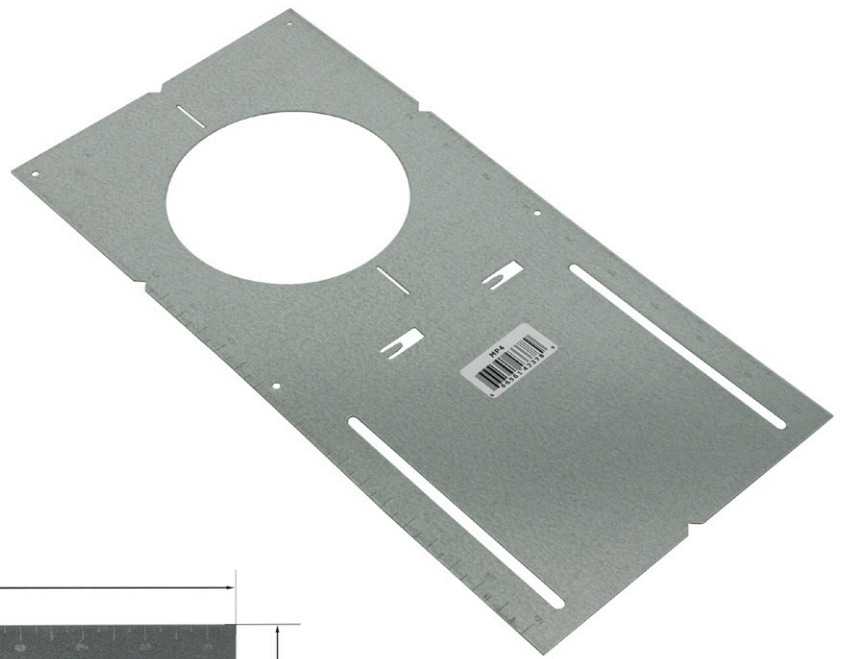

Light Measurement Report

Print date: 2023-09-25

Measurement date and time: 2023-09-25 11:12:19 AM – Measurement no. VFR-230925-0323-MS

Luminous Intensity diagram

Unit: 0-100% of peak intensity

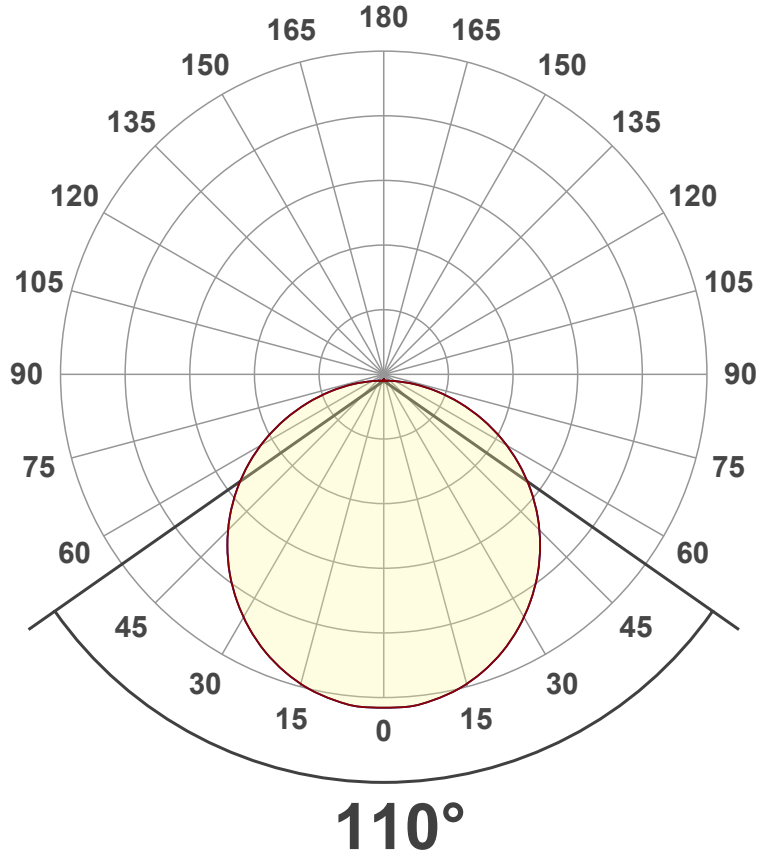

Main Values

Output (total Lumen)	800 lm
Lumen Up% / Down%	0.71% / 99.29%
Peak Intensity	262 cd
Beam Angle (50%)	110°
Beam Angle (90%)	116.6°
Beam Angle (10%)	116.6°

Cut-off Angle

Average 2,5%	181°
--------------	------

Field Angle

Average 10%	167.4°
-------------	--------

Intensity Ratio

In 120° cone	75.5%
In 90° cone	50.8%

C000-C180
C090-C270

Linear distribution diagram - Intensity (candela) vs γ -angle

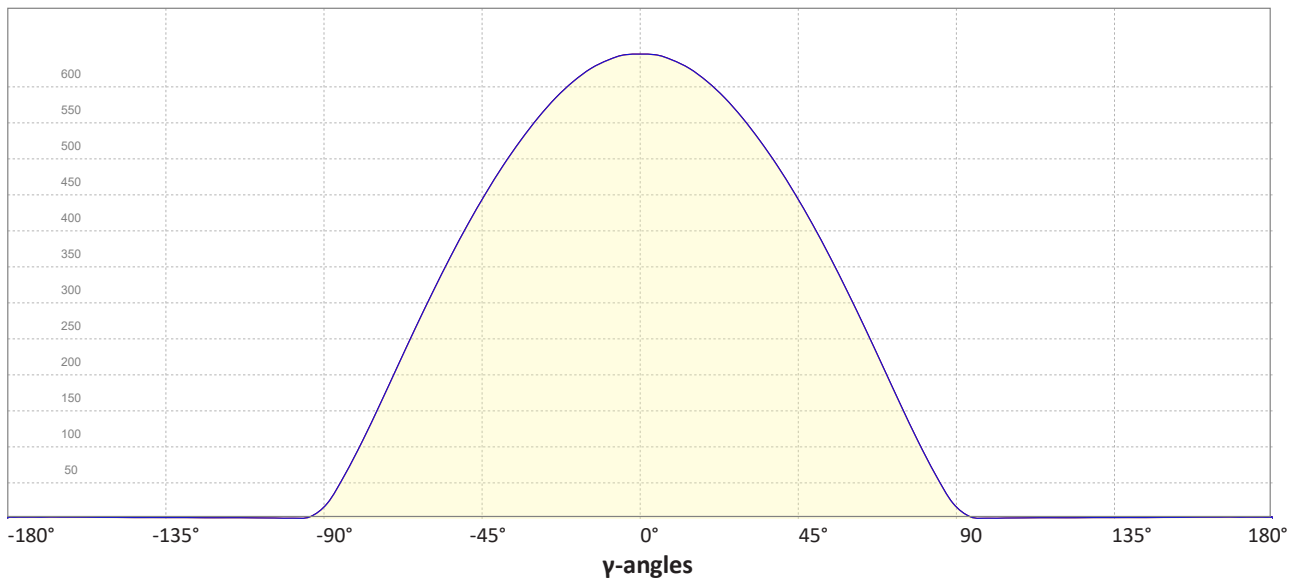

Light Measurement Report

Print date: 2023-09-25

Measurement date and time: 2023-09-25 11:12:19 AM – Measurement no. VFR-230925-0323-MS

[J925-001955](#)

Color details

Correlated Color Temperature, Target CCT = 3000 K
 Correlated Color Temperature, Measured CCT = 3016 K
 Color Rendering Index CRI 95.7
 Color Rendering Index, R9 (red component) R9 = 77.1
 Color Rendering TM30-18 R_f 92.6 – R_g 101.9
 Color Quality Scale CQS = 92.1

MacAdam Steps SDCM = 2.9
 Color coordinates CIE 1931 (x;y) = (0.437;0.404)
 Color coordinate CIEs 1960 (u;v) = (0.251;0.348)
 Color deviation from BBL Duv = -0.0028
 Color coordinate CIEs 1976 (CIELUV) (u';v') = (0.251;0.521)

CIE 1931

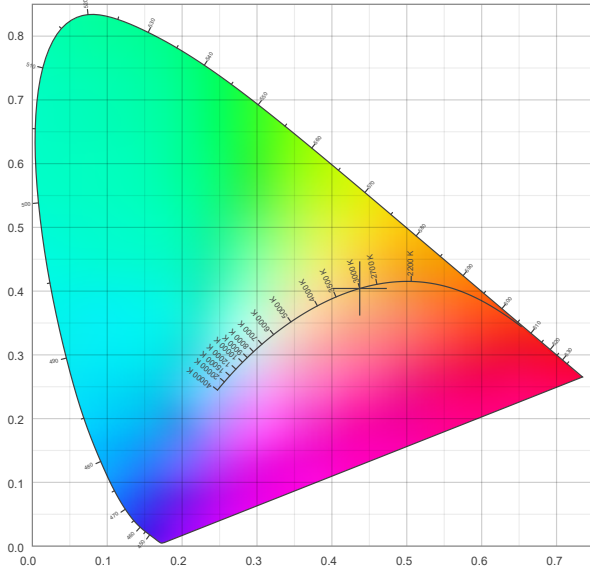

CIE 1931 – zoomed on Planckian locus

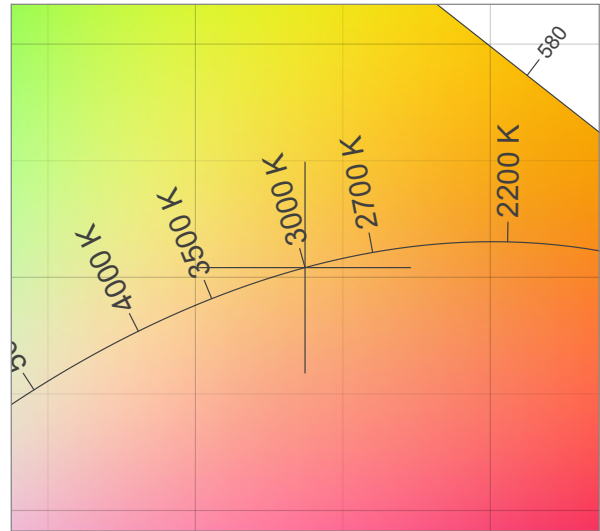

Color Rendering Index per reference color (CIE 1995)

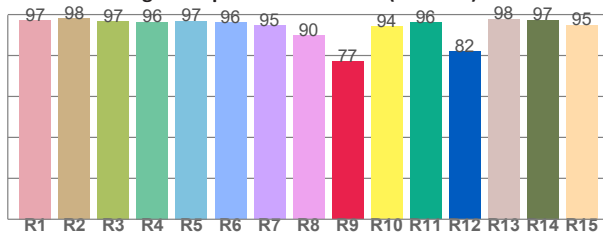

CRI R values, only R1-R8 are used to calculate final CRI value

R1	R2	R3	R4	R5	R6	R7	R8	R9	R10	R11	R12	R13	R14	R15
97.2	98.0	96.8	96.3	96.8	96.1	94.6	89.8	77.1	94.1	96.1	82.0	97.8	97.4	94.9

Spectral power distribution (SPD) / W/nm – 0-100%

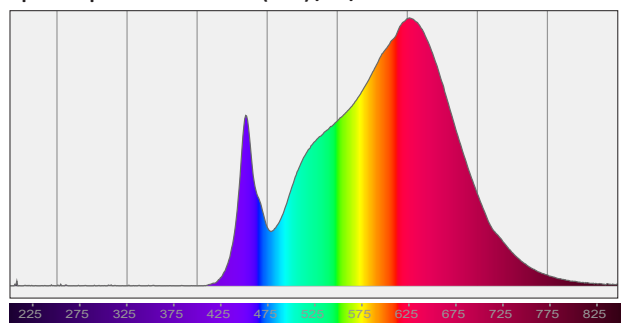

TM30-18 Rf-values per hue bin

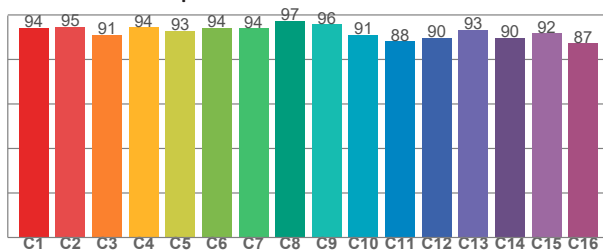

TM30 C values, 16 binned values out of total of 99 C values

C1	C2	C3	C4	C5	C6	C7	C8	C9	C10	C11	C12	C13	C14	C15	C16
94.2	94.7	91.0	94.5	93.0	94.1	94.0	97.3	95.9	91.0	88.2	89.6	93.5	89.8	91.8	87.4

Color Quality Scale by reference color

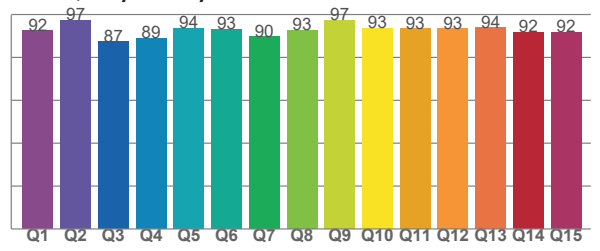

CQS Q values

Q1	Q2	Q3	Q4	Q5	Q6	Q7	Q8	Q9	Q10	Q11	Q12	Q13	Q14	Q15
92.5	97.2	87.3	88.8	93.6	93.0	89.7	92.7	97.4	93.5	93.4	93.3	93.7	91.8	91.9

Light Measurement Report

Print date: 2023-09-25

Measurement date and time: 2023-09-25 11:12:19 AM – Measurement no. VFR-230925-0323-MS

[925-001955](#)

Beam Details

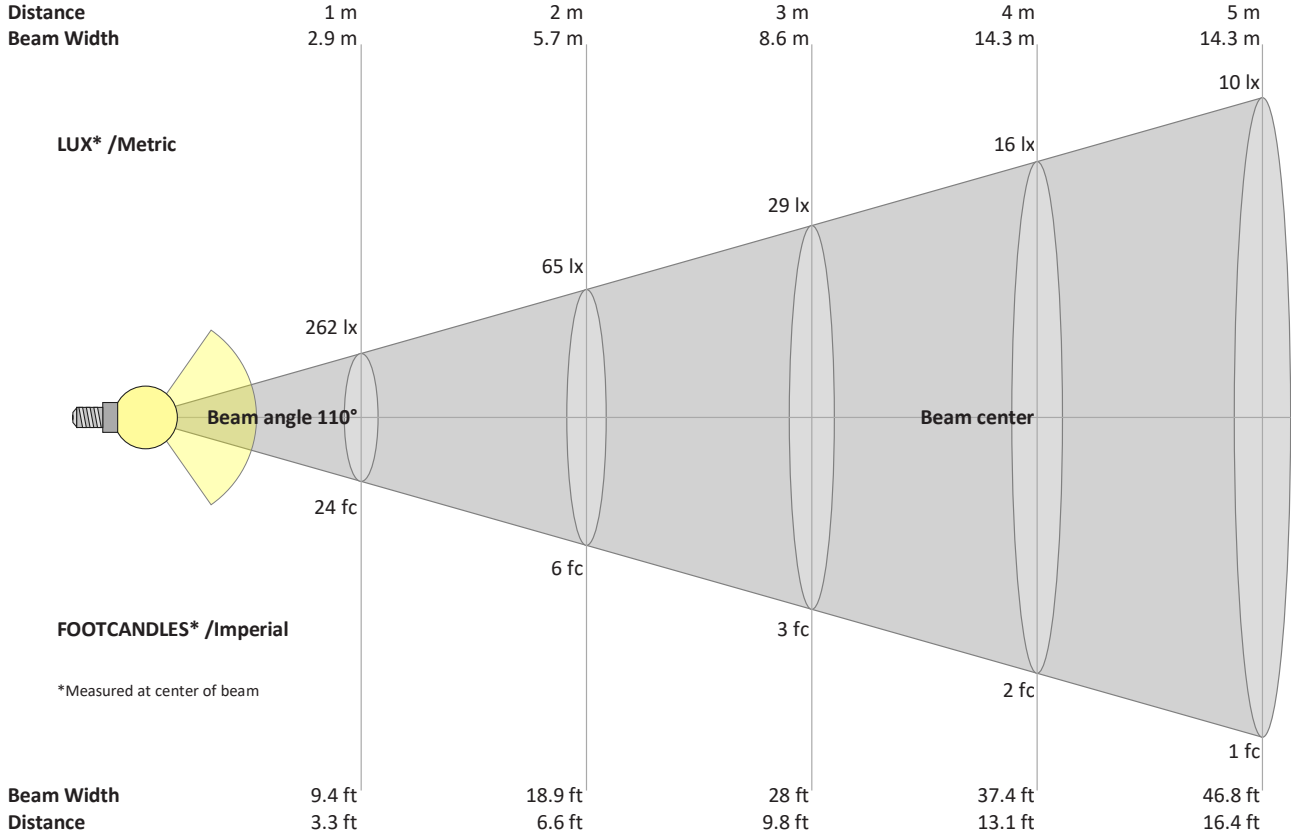

Beam intensities from 1 – 20 m

1	2	3	4	5	6	7	8	9	10	11	12	13	14	15	16	17	18	19	20	m	
3.3	6.6	9.8	13.1	16.4	19.7	23	26.2	29.5	32.8	36.1	39.4	42.7	45.9	49.2	52.5	55.8	59.1	62.3	65.6	ft	
262	65	29	16	10	7	5	4	3	3	2	2	2	1	1	1	1	1	1	1	1	lux
24.3	6.1	2.7	1.5	1	0.7	0.5	0.4	0.3	0.2	0.2	0.2	0.1	0.1	0.1	0.1	0.1	0.1	0.1	0.1	0.1	fc

Intensities in 0° c-plane

0°	5°	10°	15°	20°	25°	30°	35°	40°	45°	50°	55°	60°	65°	70°	75°	80°	85°	90°	95°	y
262	261	258	253	245	235	224	211	196	180	163	144	124	103	82	61	40	22	7	1	cd
100%	100%	99%	96%	94%	90%	85%	80%	75%	69%	62%	55%	47%	39%	31%	23%	15%	8%	3%	0%	of 0°val

Intensities in 90° c-plane

0°	5°	10°	15°	20°	25°	30°	35°	40°	45°	50°	55°	60°	65°	70°	75°	80°	85°	90°	95°	y
262	261	258	253	245	235	224	211	196	180	163	144	124	103	82	61	40	22	7	1	cd
100%	100%	99%	96%	94%	90%	85%	80%	75%	69%	62%	55%	47%	39%	31%	23%	15%	8%	3%	0%	of 0°val

Intensities in 180° c-plane

0°	5°	10°	15°	20°	25°	30°	35°	40°	45°	50°	55°	60°	65°	70°	75°	80°	85°	90°	95°	y
262	261	258	253	245	235	224	211	196	180	163	144	124	103	82	61	40	22	7	1	cd
100%	100%	99%	96%	94%	90%	85%	80%	75%	69%	62%	55%	47%	39%	31%	23%	15%	8%	3%	0%	of 0°val

Intensities in 270° c-plane

0°	5°	10°	15°	20°	25°	30°	35°	40°	45°	50°	55°	60°	65°	70°	75°	80°	85°	90°	95°	y
262	261	258	253	245	235	224	211	196	180	163	144	124	103	82	61	40	22	7	1	cd
100%	100%	99%	96%	94%	90%	85%	80%	75%	69%	62%	55%	47%	39%	31%	23%	15%	8%	3%	0%	of 0°val