

VEROBOARD®

2" Mini LED IC Rated Recessed Downlight



Veroboard 2-inch downlight is an IC-rated recessed light fixture. The fixture is available in both round and square trims and comes with housing. The IC rating housing prevents the engine from overheating thereby, increasing its life cycle. Moreover, they are designed to connect to a 12V class 2 power supply. This light fixture is air-tight and does not require any additional housing for installation. It is simple to install in a 2 in (50 mm) hole size with easy push spring clips. Furthermore, this fixture has a rendering index of 90+, making objects visible in high-quality colors when illuminated.

SPECIFICATIONS

Engine Model No:	LED-1-S6W-3KWH-12V-SQ
Voltage:	12V AC/DC
Wattage:	6W
Color Temperature:	3000K (Warm White)
Beam Angle:	40°
Dimmable:	Yes
Dimming:	100 - 10%
Dimmers:	LED/CEL Dimmers
IC Rated:	Yes
Brightness:	480 Lumens
Rendering Index:	CRI>90
LED Type:	Integrated COB LED
Fixture Color:	White
Available Trim Shape:	Round and Square
Rated Life:	50,000 Hours
Installation:	Recessed/Flush Mount
IP Rating:	IP20 (Damp Locations)
Installation Location:	Insulated Ceilings and Damp Locations
Outer Dimensions:	57x 57 x 73.3 mm (2.25 x 2.25 x 2.89 in)
Cut Size:	50mm (2 in)
Package Content:	IC-Rated Square Downlight
Package Dimensions:	2.8 x 2.4 x 4 in (7.2 x 6.1 x 10.2 cm)
Package Weight:	0.218 Kg
Certification:	FCC/ETL/RoHS



Safety and Warning

The fixture must be wired in accordance with local electrical codes. And all the installation must be done by a certified electrician. Please be sure the main power switch is OFF before the installation or attempting any maintenance.

The downlights are intended for use with any 12V AC/DC 60W max class 2 power supply. Read all the instructions from the installation manual before installing. This product is for indoor applications only.

Name: _____

Quantity: _____

Phone: _____

Email: _____

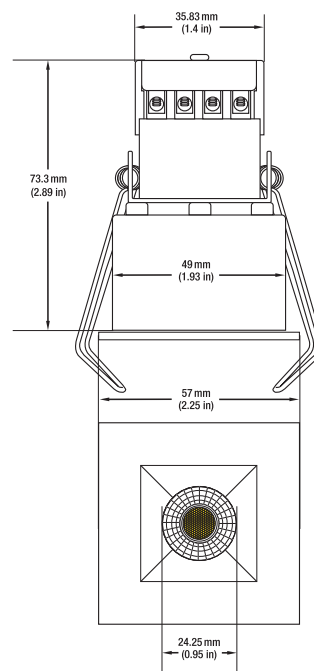
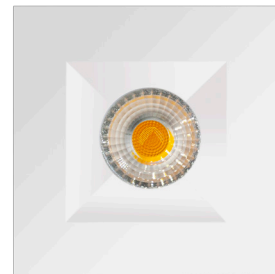

SKU: 666561425043

Light Measurement Report

Print date: 2023-01-11

Measurement date and time: 2023-01-11 3:47:12 PM – Measurement no. VFR-230111-0100-MS

Luminous Intensity diagram

Unit: 0-100% of peak intensity

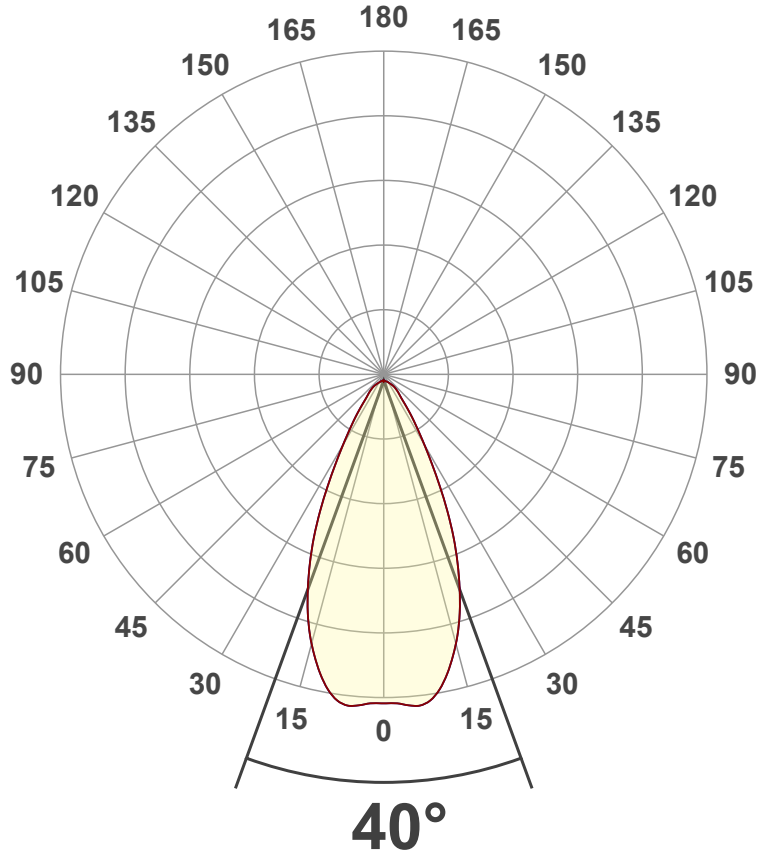

Main Values

Output (total Lumen)	480 lm
Lumen Up% / Down%	0.02% / 99.98%
Peak Intensity	577 cd
Beam Angle (50%)	40°
Beam Angle (90%)	50.1°
Beam Angle (10%)	50.1°

Cut-off Angle

Average 2,5%	131.3°
--------------	--------

Field Angle

Average 10%	84.8°
-------------	-------

Intensity Ratio

In 120° cone	94.9%
In 90° cone	86.2%

C000-C180
C090-C270

Linear distribution diagram - Intensity (candela) vs γ -angle

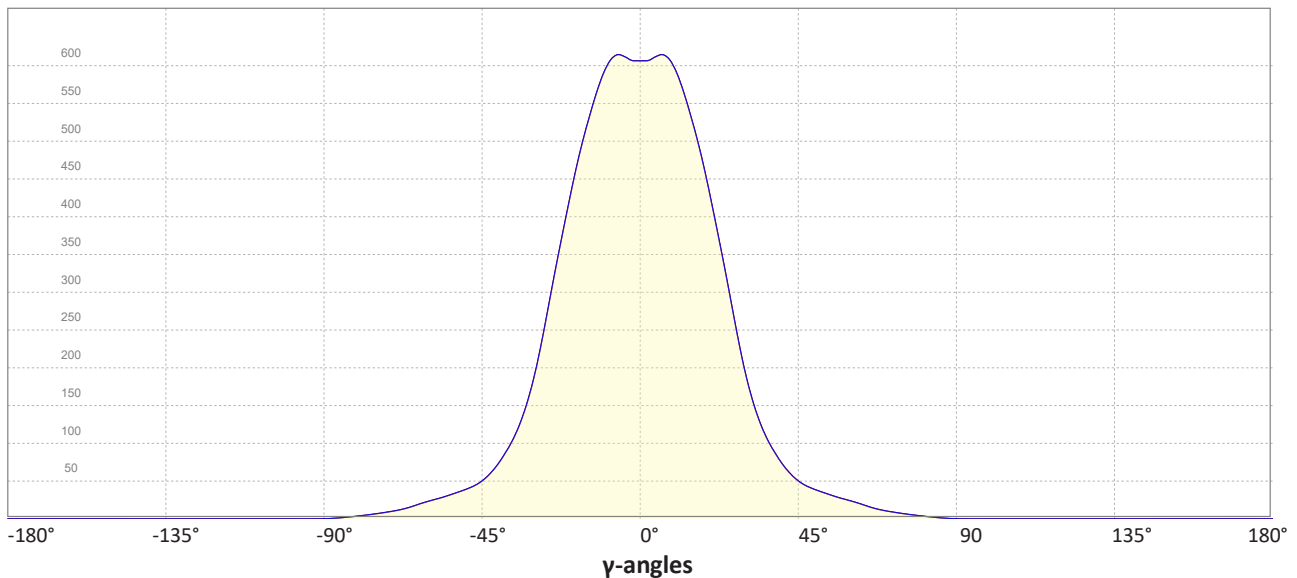

Light Measurement Report

Print date: 2023-01-11

Measurement date and time: 2023-01-11 3:47:12 PM – Measurement no. VFR-230111-0100-MS

Color details

Correlated Color Temperature, Target CCT = 3000 K
 Correlated Color Temperature, Measured CCT = 3034 K
 Color Rendering Index CRI 92.0
 Color Rendering Index, R9 (red component) R9 = 53.0
 Color Rendering TM30-18 R_f 91.8 – R_g 98.7
 Color Quality Scale CQS = 90.8

MacAdam Steps
 Color coordinates CIE 1931 (x;y) = (0.437;0.404)
 Color coordinate CIEs 1960 (u;v) = (0.251;0.348)
 Color deviation from BBL Duv = 0.0013
 Color coordinate CIEs 1976 (CIELUV) (u';v') = (0.251;0.251)

CIE 1931



CIE 1931 – zoomed on Planckian locus

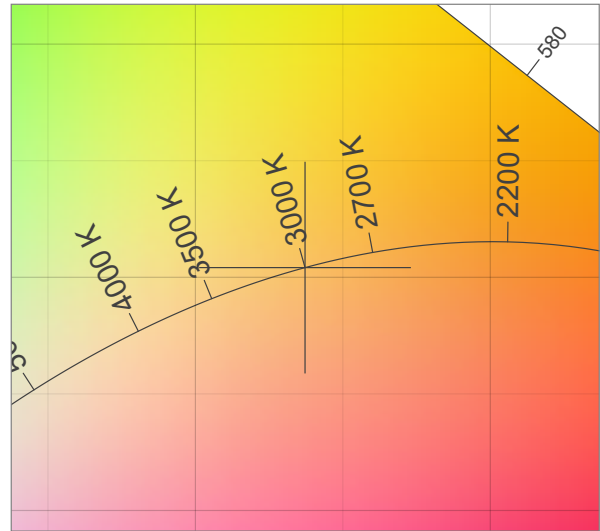

Color Rendering Index per reference color (CIE 1995)

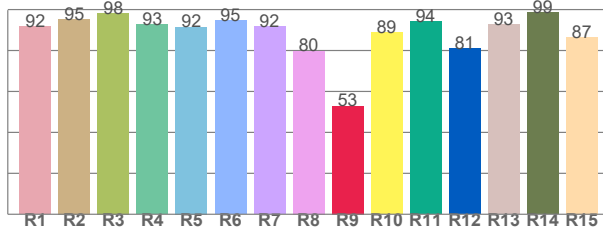

CRI R values, only R1-R8 are used to calculate final CRI value

R1	R2	R3	R4	R5	R6	R7	R8	R9	R10	R11	R12	R13	R14	R15
91.7	95.3	98.3	92.8	91.6	94.7	91.8	79.8	53.0	88.9	94.2	81.0	92.6	98.5	86.5

Spectral power distribution (SPD) / W/nm – 0-100%

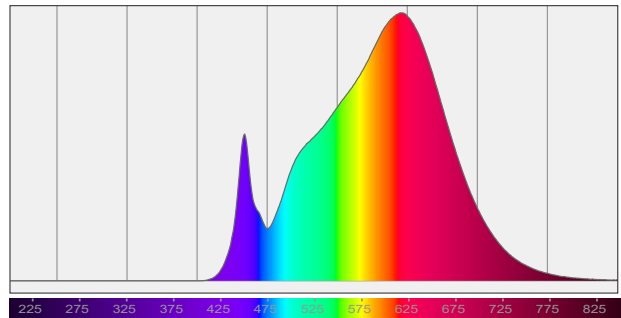

TM30-18 Rf-values per hue bin

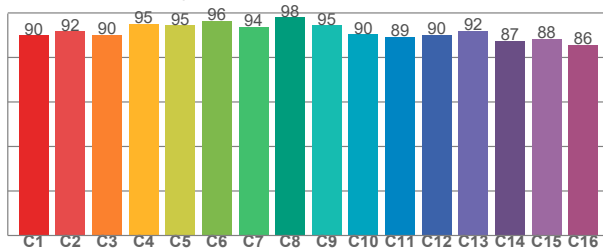

TM30 C values, 16 binned values out of total of 99 C values

C1	C2	C3	C4	C5	C6	C7	C8	C9	C10	C11	C12	C13	C14	C15	C16
89.9	91.7	90.1	95.2	94.5	96.5	93.8	98.0	94.5	90.5	89.2	90.1	91.9	87.4	88.4	85.7

Color Quality Scale by reference color

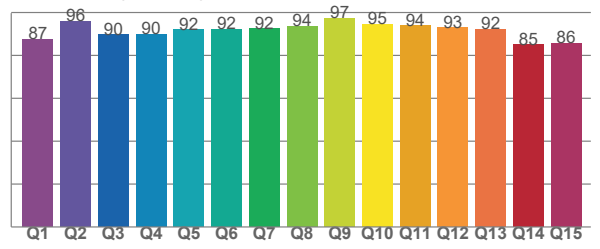

CQS Q values

Q1	Q2	Q3	Q4	Q5	Q6	Q7	Q8	Q9	Q10	Q11	Q12	Q13	Q14	Q15
87.4	95.9	89.6	89.7	91.9	92.1	92.4	93.6	97.4	94.6	93.8	92.9	92.1	84.9	85.8

Light Measurement Report

Print date: 2023-01-11

Measurement date and time: 2023-01-11 3:47:12 PM – Measurement no. VFR-230111-0100-MS

Beam Details

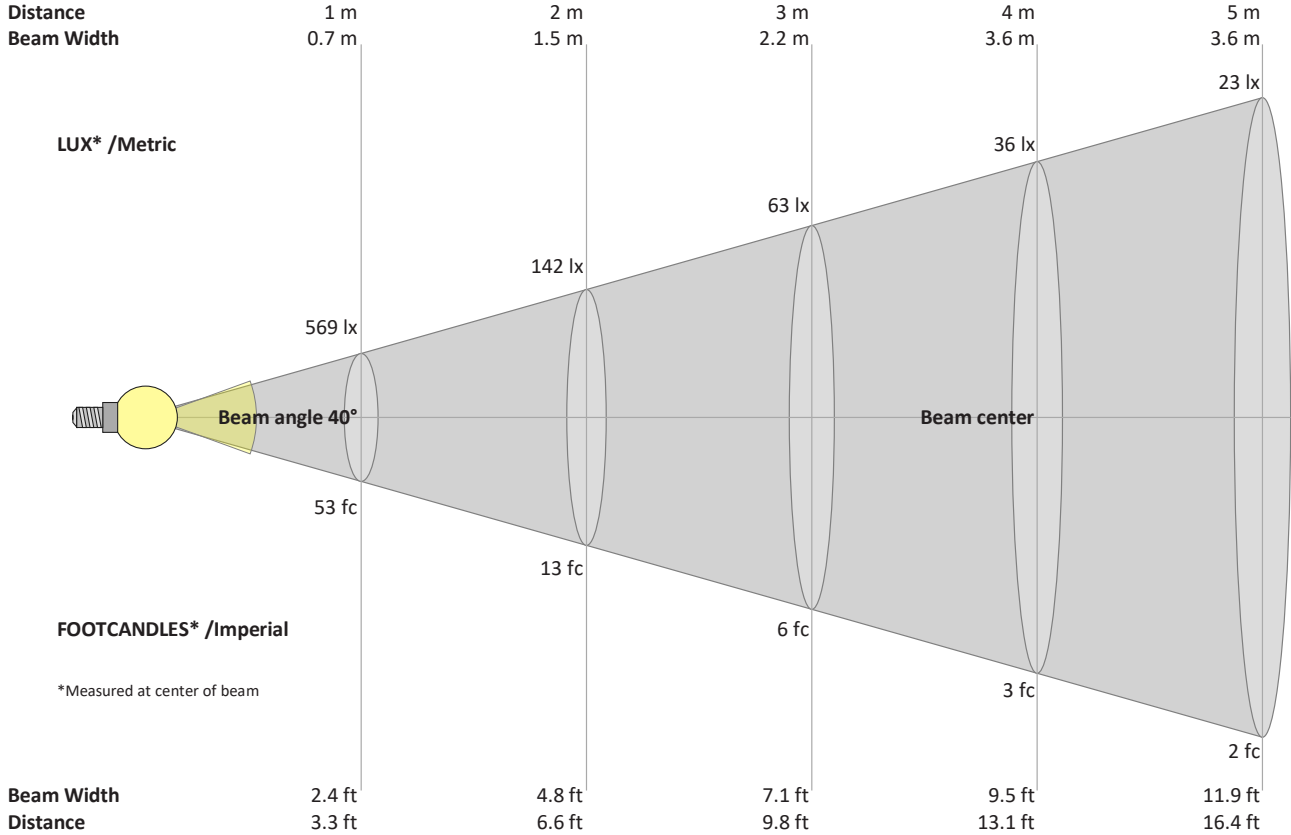

Beam intensities from 1 – 20 m

1	2	3	4	5	6	7	8	9	10	11	12	13	14	15	16	17	18	19	20	m
3.3	6.6	9.8	13.1	16.4	19.7	23	26.2	29.5	32.8	36.1	39.4	42.7	45.9	49.2	52.5	55.8	59.1	62.3	65.6	ft
569	142	63	36	23	16	12	9	7	6	5	4	3	3	3	2	2	2	2	1	lux
52.9	13.2	5.9	3.3	2.1	1.5	1.1	0.8	0.7	0.5	0.4	0.4	0.3	0.3	0.2	0.2	0.2	0.2	0.1	0.1	fc

Intensities in 0° c-plane

0°	2°	4°	6°	8°	10°	12°	14°	16°	18°	20°	22°	24°	26°	28°	30°	32°	34°	36°	38°	y
569	570	574	576	572	558	535	507	475	439	399	357	313	267	221	181	148	121	101	85	cd
100%	100%	101%	101%	100%	98%	94%	89%	83%	77%	70%	63%	55%	47%	39%	32%	26%	21%	18%	15%	of 0°val

Intensities in 90° c-plane

0°	2°	4°	6°	8°	10°	12°	14°	16°	18°	20°	22°	24°	26°	28°	30°	32°	34°	36°	38°	y
569	570	574	576	572	558	535	507	475	439	399	357	313	267	221	181	148	121	101	85	cd
100%	100%	101%	101%	100%	98%	94%	89%	83%	77%	70%	63%	55%	47%	39%	32%	26%	21%	18%	15%	of 0°val

Intensities in 180° c-plane

0°	2°	4°	6°	8°	10°	12°	14°	16°	18°	20°	22°	24°	26°	28°	30°	32°	34°	36°	38°	y
569	570	574	576	572	558	535	507	475	439	399	357	313	267	221	181	148	121	101	85	cd
100%	100%	101%	101%	100%	98%	94%	89%	83%	77%	70%	63%	55%	47%	39%	32%	26%	21%	18%	15%	of 0°val

Intensities in 270° c-plane

0°	2°	4°	6°	8°	10°	12°	14°	16°	18°	20°	22°	24°	26°	28°	30°	32°	34°	36°	38°	y
569	570	574	576	572	558	535	507	475	439	399	357	313	267	221	181	148	121	101	85	cd
100%	100%	101%	101%	100%	98%	94%	89%	83%	77%	70%	63%	55%	47%	39%	32%	26%	21%	18%	15%	of 0°val