

# VEROBOARD®

## 6" LED Commercial Downlight Reflector Square Trim

### SPECIFICATIONS



<b>Model No.*</b>	VBD-COM-6-XXXX-6S			
<b>Voltage</b>	120-347V AC			
<b>Frequency</b>	50/60Hz			
<b>Wattage</b>	20W			
<b>Input Current</b>	0.2A			
<b>Available Colour Temperatures</b>	<table border="1"> <tr> <td>WARM WHITE 3000K</td> <td>NATURAL WHITE 4000K</td> <td>DAY LIGHT 5000K</td> </tr> </table>	WARM WHITE 3000K	NATURAL WHITE 4000K	DAY LIGHT 5000K
WARM WHITE 3000K	NATURAL WHITE 4000K	DAY LIGHT 5000K		
<b>Brightness</b>	1585Lm			
<b>Trim Type</b>	Open Reflector Trim			
<b>Beam Angle</b>	80°			
<b>Colour</b>	White			
<b>Lifespan</b>	50,000 Hours			
<b>Dimmable</b>	Yes (0-10 Dimming)			
<b>Package Content</b>	J Box structured engine, Reflector trim			
<b>Dimensions (Reflector)</b>	Width & Length: 189mm (7.43") Overall Depth: 133.35mm (5.25")			
<b>Dimensions (Cut Size)</b>	152.92mm (6")			

\* Please see the "Ordering Guide" table at the bottom of this page for how to place your order.

### Features

- Comes with a 20W engine that has an inbuilt LED Driver, J-Box structured with good heat dissipation.
- Choose the options which best suits you. Warm White (3000K), Natural White (4000K), and Daylight (5000K).
- The 20W engine is compatible with all commercial lighting reflector trims (CPS series Model).
- Applicable for Indoor use only (dry and damp locations).
- Has a lifespan of 50,000 hours.
- It can be dimmed using a 0-10v dimmer.
- These commercial downlights come in 4 inches, 6 inches, in different shapes (Round, Square).
- We also carry this engine downlight for sloped ceilings in wall wash trims.
- Easy for installation with push springs.
- The J-Box engine has an anti-UV Frosted Polycarbonate Lens that helps in even light transmission, prevents discoloration.
- It is suitable for recessed lighting of commercial and public places and elegantly decorate the ambiance, in shopping malls, hospital, airport, hotel lobbies, and similar places.
- It is a highly efficient product with an Energy Star logo.

**ORDERING GUIDE**

Example part number: **VBD - COM - 6 - XXXX - 6S**

MODEL	SERIES	DIAMETER	COLOUR	REFLECTOR SHAPE
VBD	COM	XXX	XXXX	XXXX
		4" 6" 8"	3000K 4000K 5000K	6R 4S 4SLR 4SLR 8R 6S 6SLR 6SLR



AVAILABLE COLOR TEMPERATURE  
3000K • 4000K • 5000K

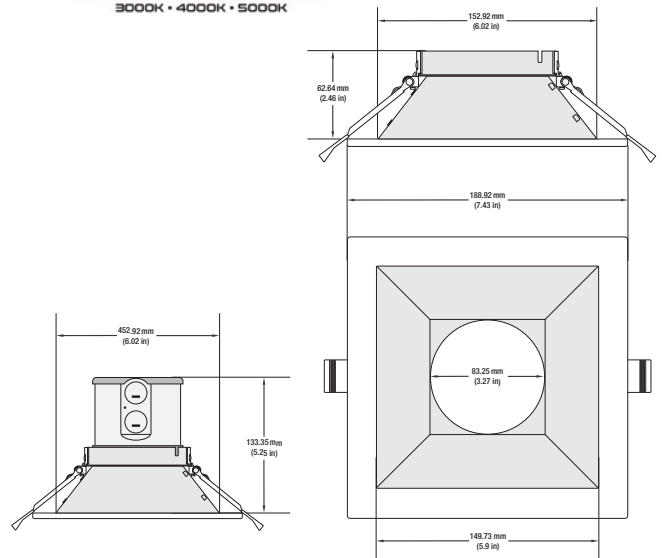

### Safety and Warning

The fixture must be wired in accordance with local electrical codes. All the installation must be done by a certified electrician. Do not modify the product, any modification may render the product unsafe and void the warranty.



# New Construction Universal Mounting Plate

*(Sold separately)*

New Construction Universal Mounting Plate suitable for 3, 4, and 6-inch fixtures, with two hanger bars.  
Model: **VBD-MP-UNV-346** | SKU: **666561433796**

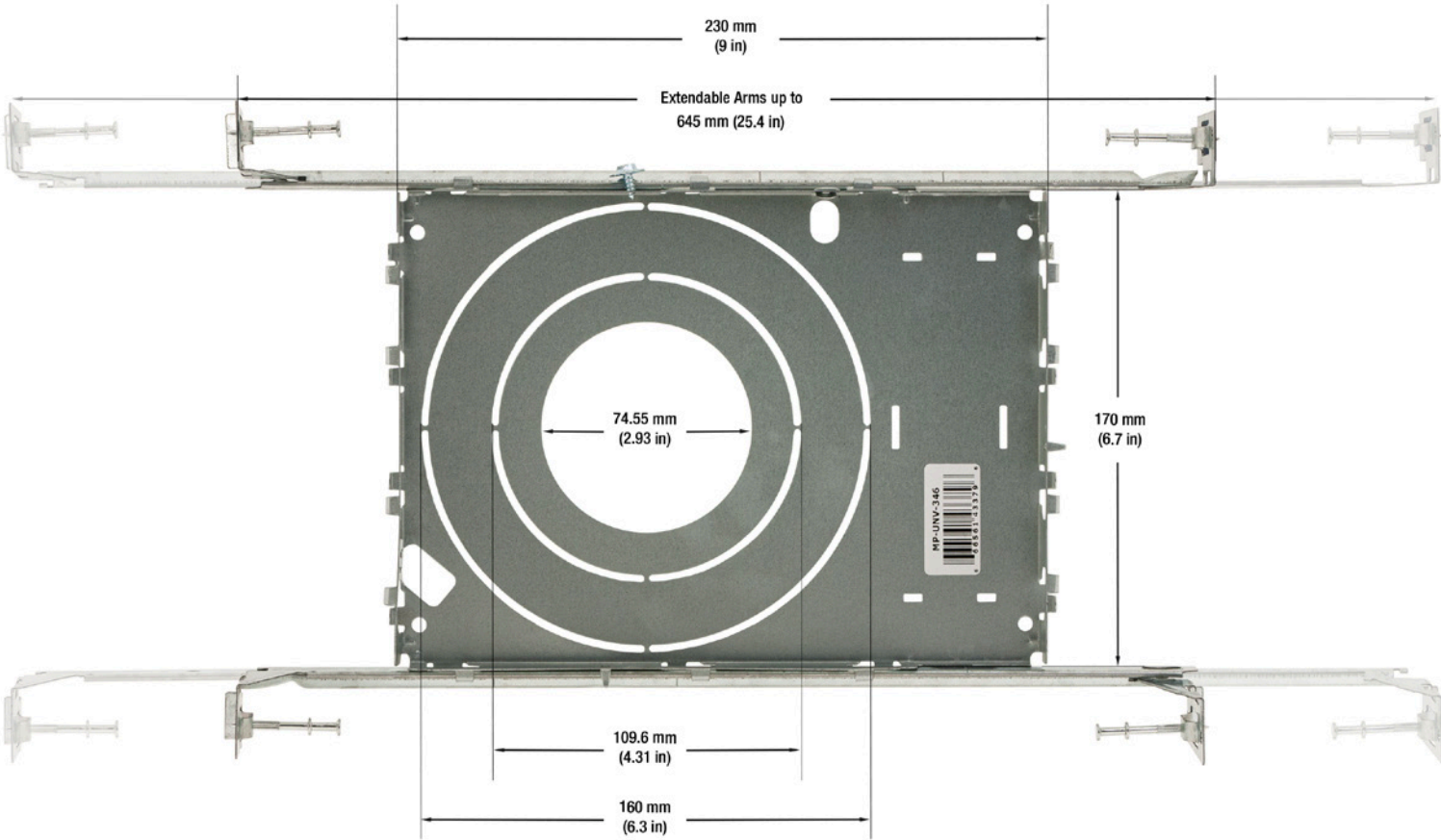
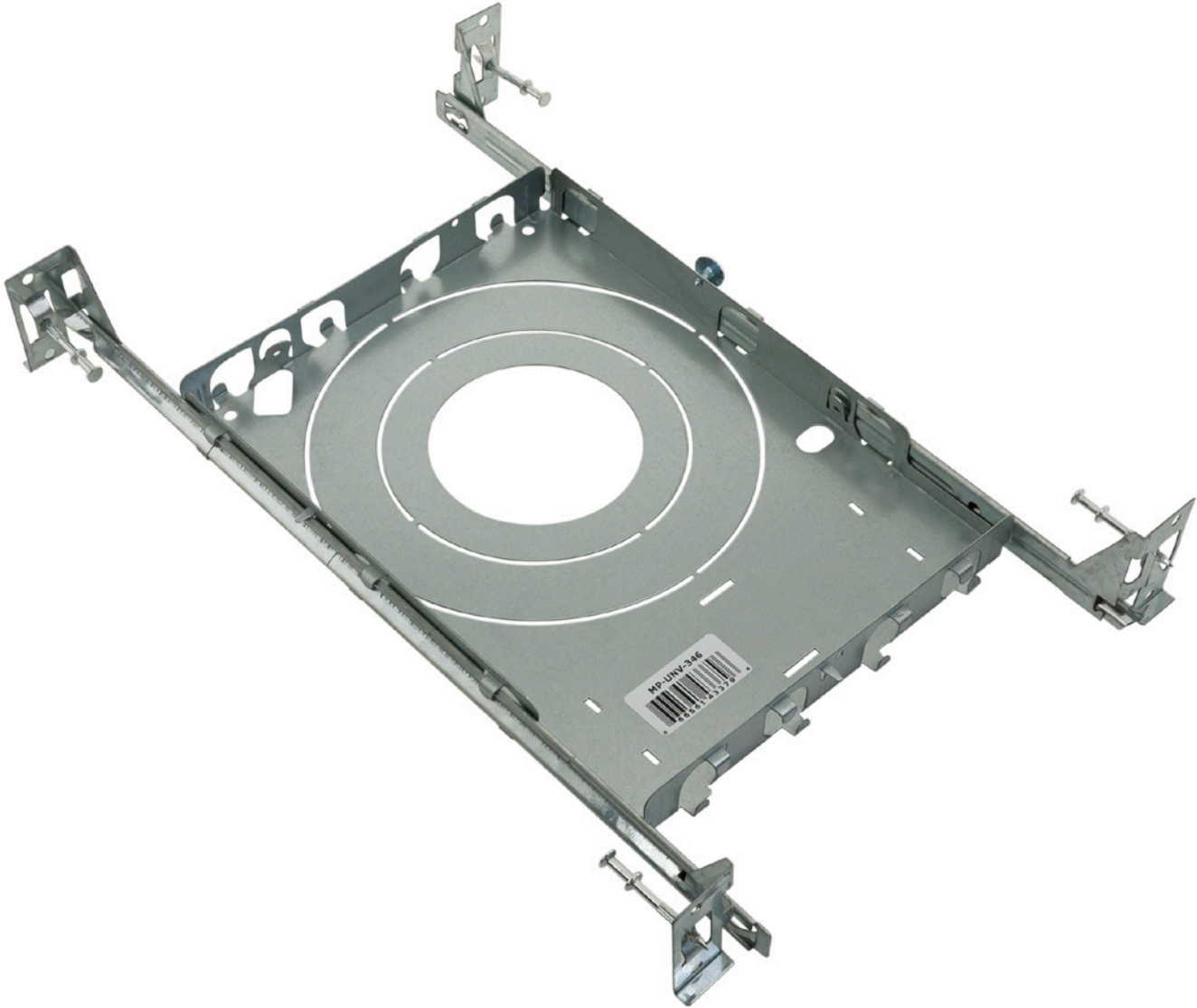

# Light Measurement Report

Print date: 2023-01-26

Measurement date and time: 2023-01-26 9:28:35 AM – Measurement no. VFR-230126-0004-MS

## Luminous Intensity diagram

Unit: 0-100% of peak intensity

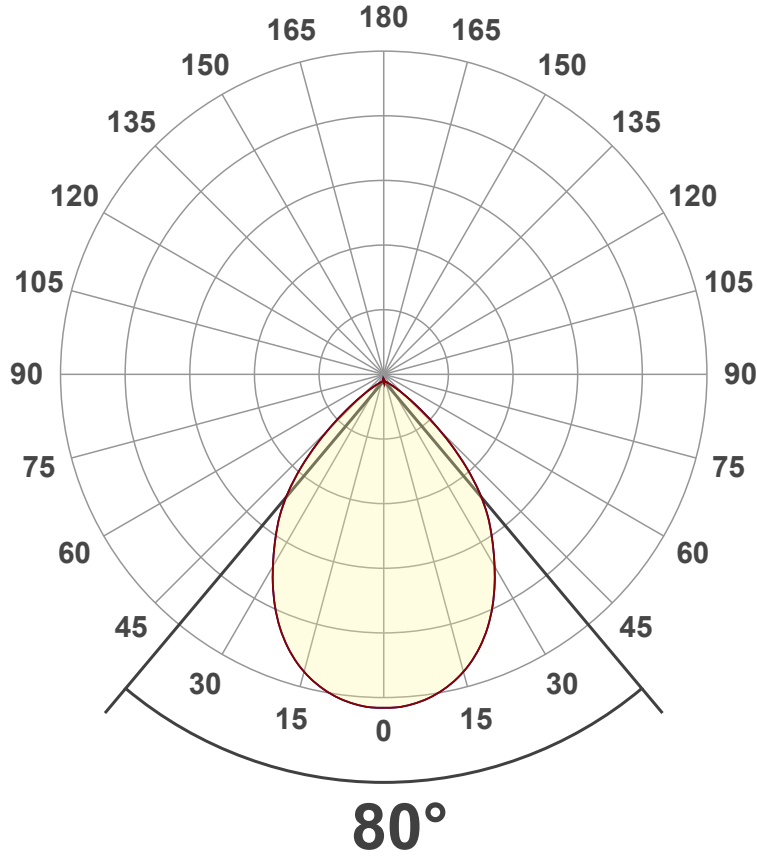

### Main Values

Output (total Lumen)	1585 lm
Lumen Up% / Down%	0.08% / 99.92%
Peak Intensity	1087 cd
Beam Angle (50%)	80°
Beam Angle (90%)	78.2°
Beam Angle (10%)	78.2°

### Cut-off Angle

Average 2,5%	123.8°
--------------	--------

### Field Angle

Average 10%	109.9°
-------------	--------

### Intensity Ratio

In 120° cone	98.8%
In 90° cone	84.8%

**C000-C180**  
**C090-C270**

## Linear distribution diagram - Intensity (candela) vs $\gamma$ -angle

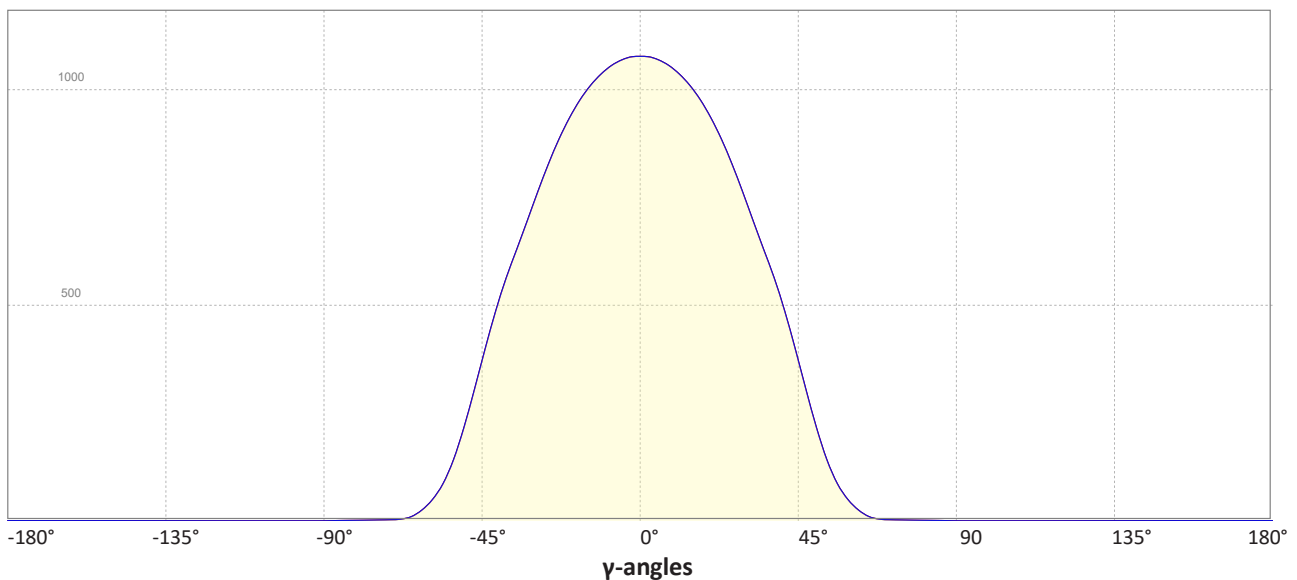

# Light Measurement Report

Print date: 2023-01-26

Measurement date and time: 2023-01-26 9:28:35 AM – Measurement no. VFR-230126-0004-MS

## Color details

Correlated Color Temperature, Target CCT = 3000 K  
 Correlated Color Temperature, Measured CCT = 2925 K  
 Color Rendering Index CRI 82.7  
 Color Rendering Index, R9 (red component) R9 = 6.5  
 Color Rendering TM30-18 R<sub>f</sub> 84.5 – R<sub>g</sub> 94.0  
 Color Quality Scale CQS = 82.0

MacAdam Steps  
 Color coordinates CIE 1931 (x;y) = (0.437;0.404)  
 Color coordinate CIEs 1960 (u';v') = (0.251;0.348)  
 Color deviation from BBL Duv = -0.0022  
 Color coordinate CIEs 1976 (CIELUV) (u'';v'') = (0.251;0.251)

### CIE 1931

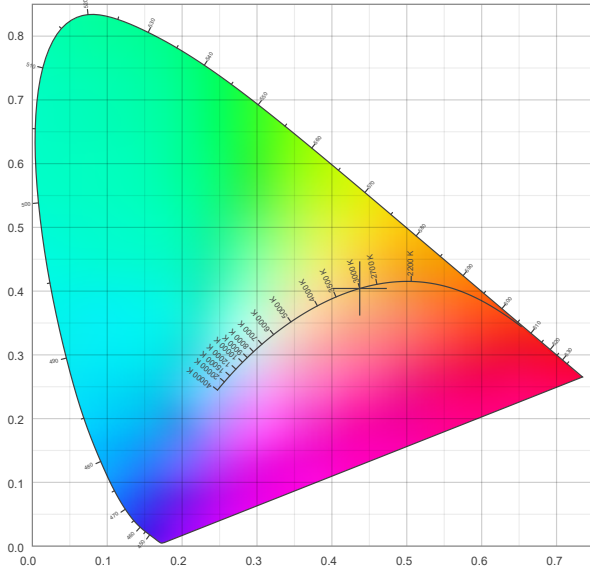

### CIE 1931 – zoomed on Planckian locus

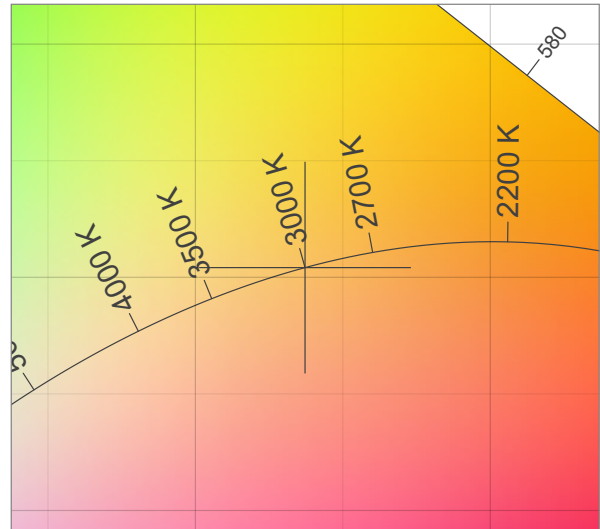

### Color Rendering Index per reference color (CIE 1995)

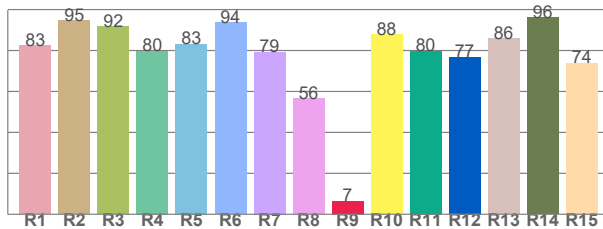

CRI R values, only R1-R8 are used to calculate final CRI value

R1	R2	R3	R4	R5	R6	R7	R8	R9	R10	R11	R12	R13	R14	R15
82.5	94.6	91.8	79.7	83.2	93.6	79.4	56.5	6.5	87.8	79.8	76.8	85.9	96.2	74.0

### Spectral power distribution (SPD) / W/nm – 0-100%

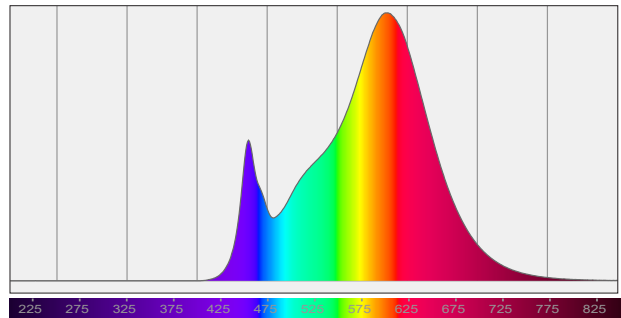

### TM30-18 Rf-values per hue bin

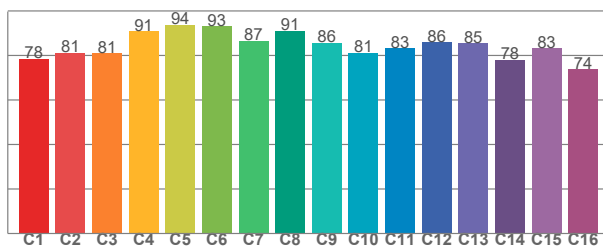

TM30 C values, 16 binned values out of total of 99 C values

C1	C2	C3	C4	C5	C6	C7	C8	C9	C10	C11	C12	C13	C14	C15	C16
78.5	81.2	80.9	91.0	93.8	93.1	86.5	91.1	85.7	81.2	83.3	85.9	85.4	78.1	83.3	73.8

### Color Quality Scale by reference color

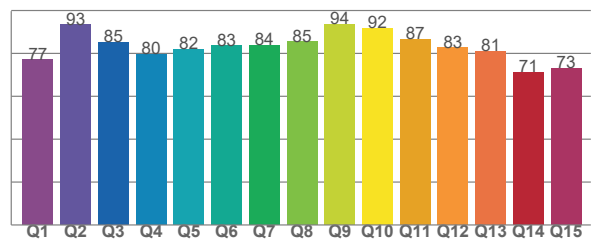

CQS Q values

Q1	Q2	Q3	Q4	Q5	Q6	Q7	Q8	Q9	Q10	Q11	Q12	Q13	Q14	Q15
77.1	93.3	85.3	79.7	82.0	83.5	83.7	85.4	93.5	91.6	86.7	82.6	81.1	71.2	73.1

# Light Measurement Report

Print date: 2023-01-26

Measurement date and time: 2023-01-26 9:28:35 AM – Measurement no. VFR-230126-0004-MS

## Beam Details

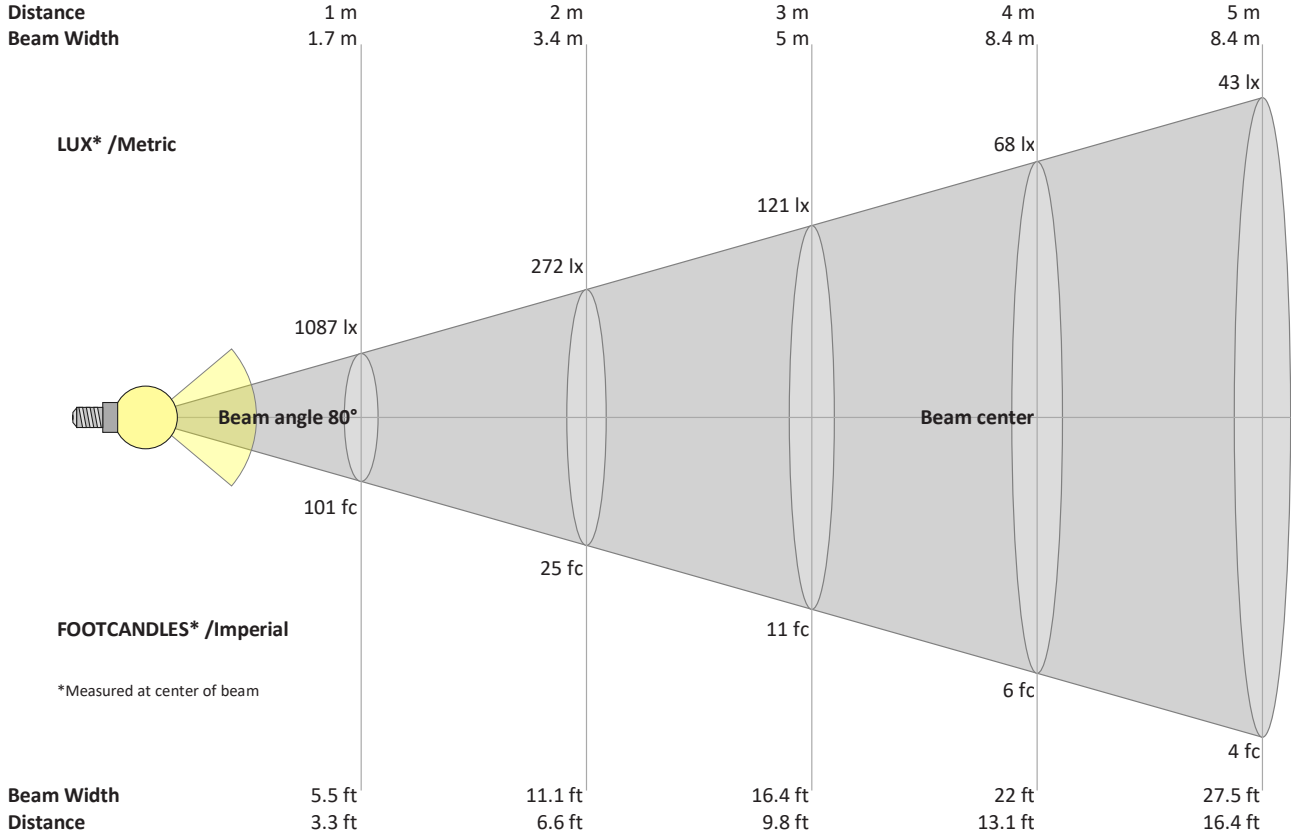

### Beam intensities from 1 – 20 m

1	2	3	4	5	6	7	8	9	10	11	12	13	14	15	16	17	18	19	20	m
3.3	6.6	9.8	13.1	16.4	19.7	23	26.2	29.5	32.8	36.1	39.4	42.7	45.9	49.2	52.5	55.8	59.1	62.3	65.6	ft
1087	272	121	68	43	30	22	17	13	11	9	8	6	6	5	4	4	3	3	3	lux
101	25.3	11.2	6.3	4	2.8	2.1	1.6	1.2	1	0.8	0.7	0.6	0.5	0.4	0.4	0.3	0.3	0.3	0.3	fc

### Intensities in 0° c-plane

0°	5°	10°	15°	20°	25°	30°	35°	40°	45°	50°	55°	60°	65°	70°	75°	80°	85°	90°	95°	y
1087	1080	1054	1010	946	858	751	639	521	376	224	108	43	11	3	2	1	1	0	0	cd
100%	99%	97%	93%	87%	79%	69%	59%	48%	35%	21%	10%	4%	1%	0%	0%	0%	0%	0%	0%	of 0°val

### Intensities in 90° c-plane

0°	5°	10°	15°	20°	25°	30°	35°	40°	45°	50°	55°	60°	65°	70°	75°	80°	85°	90°	95°	y
1087	1080	1054	1010	946	858	751	639	521	376	224	108	43	11	3	2	1	1	0	0	cd
100%	99%	97%	93%	87%	79%	69%	59%	48%	35%	21%	10%	4%	1%	0%	0%	0%	0%	0%	0%	of 0°val

### Intensities in 180° c-plane

0°	5°	10°	15°	20°	25°	30°	35°	40°	45°	50°	55°	60°	65°	70°	75°	80°	85°	90°	95°	y
1087	1080	1054	1010	946	858	751	639	521	376	224	108	43	11	3	2	1	1	0	0	cd
100%	99%	97%	93%	87%	79%	69%	59%	48%	35%	21%	10%	4%	1%	0%	0%	0%	0%	0%	0%	of 0°val

### Intensities in 270° c-plane

0°	5°	10°	15°	20°	25°	30°	35°	40°	45°	50°	55°	60°	65°	70°	75°	80°	85°	90°	95°	y
1087	1080	1054	1010	946	858	751	639	521	376	224	108	43	11	3	2	1	1	0	0	cd
100%	99%	97%	93%	87%	79%	69%	59%	48%	35%	21%	10%	4%	1%	0%	0%	0%	0%	0%	0%	of 0°val

# AVAILABLE OTHER TRIM MODELS

## 6" LED Commercial Downlight Reflector Round Trim

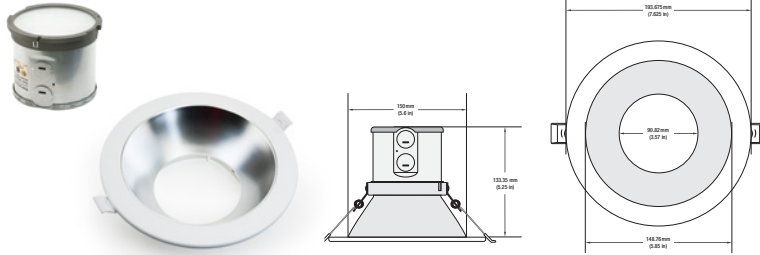

SKU: 66651415914



## 8" LED Commercial Downlight Reflector Round Trim

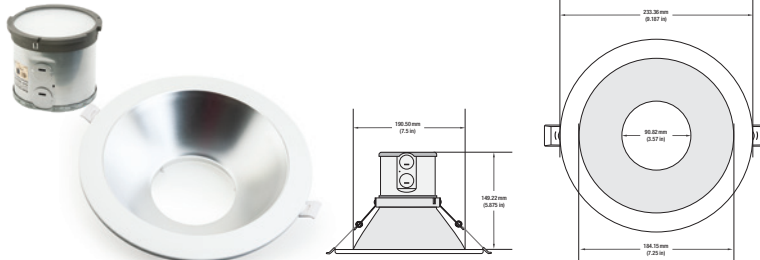

SKU: 66651415921



## 4" LED Commercial Downlight Reflector Square Trim

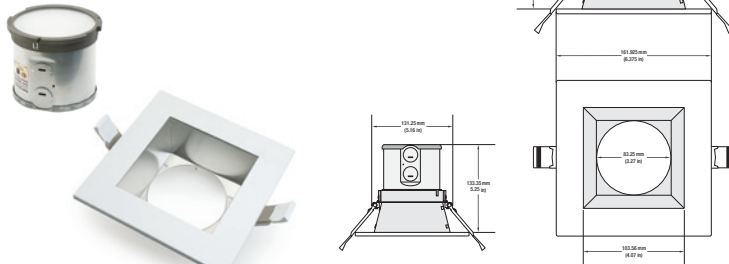

SKU: 666561419943



## 4" LED Commercial Downlight Sloped Ceiling Reflector Round Trim

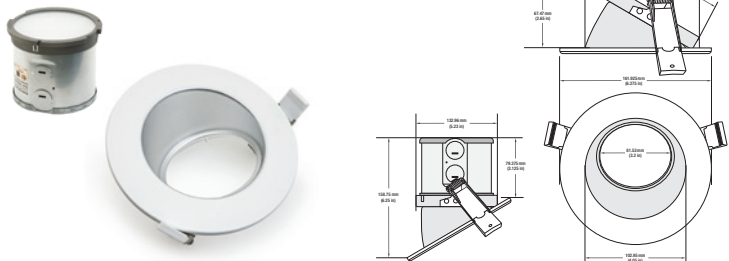

SKU: 666561419929



# AVAILABLE OTHER TRIM MODELS

## 6" LED Commercial Downlight Sloped Ceiling Reflector Round Trim

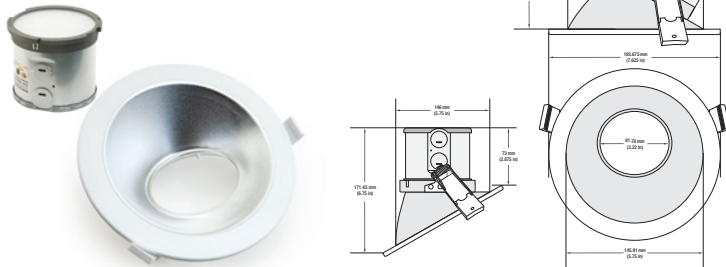

SKU: 666561419936



MODEL No. **VBD-COM-6-XXXX-6SLR**

## 4" LED Commercial Downlight Sloped Ceiling Reflector Square Trim

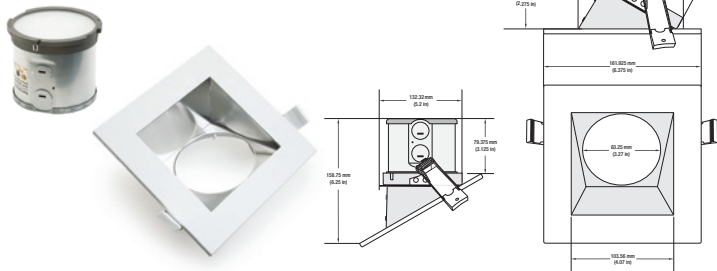

SKU: 666561419967



MODEL No. **VBD-COM-4-XXXX-4SLS**

## 6" LED Commercial Downlight Sloped Ceiling Reflector Square Trim

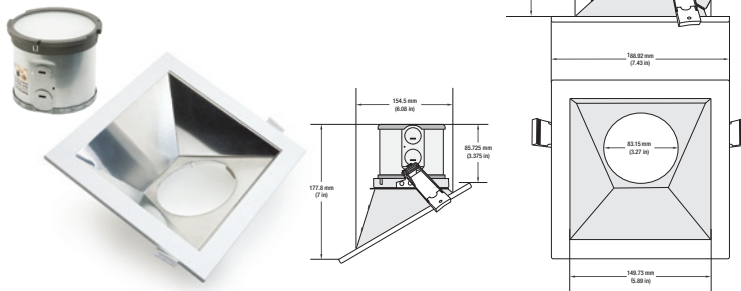

SKU: 666561419974



MODEL No. **VBD-COM-6-XXXX-6SLS**

### Notes:

### Disclaimer:

The data and information contained in this specification sheet are subject to change without notice; the ratings supplied are provided based on the product manufacturer. The information contained in this specification sheet should not be considered a warranty, expressed or implied, including, but not limited to, a warranty of merchantability or fitness for a particular purpose. In no event shall Veroboard be liable for any incidental or consequential damages resulting from the use, misuse, or inability to use the product. This exclusion applies regardless of whether such damages are sought based on breach of warranty, breach of contract, negligence, strict liability in tort, or any other legal theory.

For more information about our products and services, please visit our website: [www.veroboard.com](http://www.veroboard.com)