

# VEROBOARD®

## 7" Retaining Wall/Step Lights 12V AC/DC 2W (3000K & RGBW)

### SPECIFICATIONS

3000K (2700K with lens)



Model No:	HSC2-2W-FLT-30K
Voltage:	12V AC/DC
Wattage:	2W
Color Temperature:	3000K (2700K with lens)
Brightness:	180 Lumens
Light Source:	6 SMD
Wire Gauge:	5ft of AWG22
Beam Angle:	45°
Dimmable:	No
Dimensions:	175mm x 75mm (6.875" x 2.95")
IP Rating:	IP67 (Outdoor rated)

**SKU: 666561418182**

### FEATURES:

- **Outdoor Step Lights:** With a working temperature range of -4° F-122° F and an IP67 waterproof rating, HSC2-2W-FLT-30K LED low voltage step lights are perfect for outdoor assembly.
- **Widely Used:** Powered by 12V AC/DC voltage. This light can illuminate landscape steps, retaining walls, decks, flowerbeds, and masonry walls.
- **High Lumen Lighting:** Emitting 180Lm of 3000K (2700 with lens) soft white light, this LED hardscape light only needs 2W to match the output of a 1W halogen light. The 45° downward beam angle eliminates glare, while the CRI of 90 displays the true colors of objects.
- **Quality Assurance:** HSC2-2W-FLT-30K hardscape light's high quality and safe use are assured. It has a long 40,000hrs lifespan and comes with a two years warranty.
- **Tips:** This product only contains lights and does not contain a low-voltage power supply. The power supply needs to be purchased separately. But our landscape lights can work with a 12V AC/DC system. May you can use it in your existing power supply.

SOFT WHITE  
2700K

WARM WHITE  
3000K



### SPECIFICATIONS

RGBW



Model No:	HSC2-2W-RGBW
Voltage:	12V AC/DC
Wattage:	2W
Color Temperature:	RGBW (Multi-color)
Brightness:	180 Lumens
Light Source:	6 SMD
Wire Gauge:	5ft of AWG22
Beam Angle:	45°
Dimmable:	Yes
Dimensions:	175mm x 75mm (6.875" x 2.95")
IP Rating:	IP67 (Outdoor rated)

**SKU: 666561418199**

### FEATURES:

- **Outdoor Step Lights:** With a working temperature range of -4° F-122° F and an IP67 waterproof rating, HSC2-2W-RGBW LED low voltage step lights are perfect for outdoor assembly.
- **Widely Used:** Powered by 12V AC/DC voltage. This light can illuminate landscape steps, retaining walls, decks, flowerbeds, and masonry walls.
- **High Lumen Lighting:** Emitting 180Lm of Red, Blue, Green, and White and any color in between. The 45° downward beam angle eliminates glare.
- **Quality Assurance:** HSC2-2W-RGBW hardscape light's high quality and safe use are assured. It has a long 40,000hrs lifespan and comes with a two years warranty.
- **Tips:** This product only contains lights and does not contain a controller or low-voltage power supply. The controller and power supply need to be purchased separately. But our landscape lights can work with a 12V AC/DC system. May you can use it in your existing power supply.

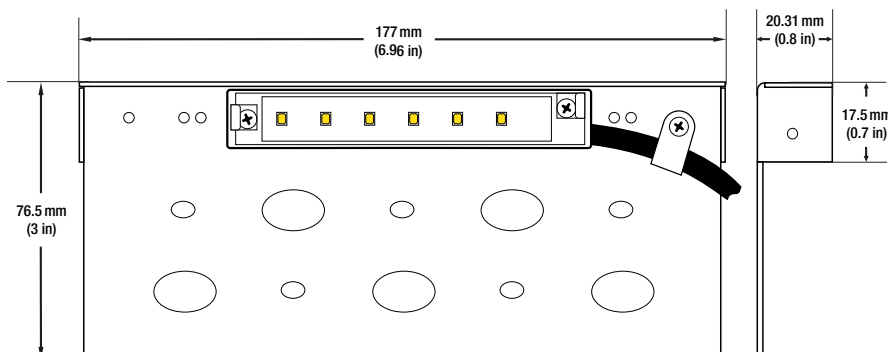

For more information about our products and services, please visit our website: [www.veroboard.com](http://www.veroboard.com)

## ACCESSORIES (Sold Separately)

### Face Trims

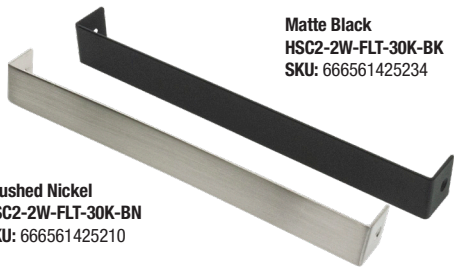

**Matte Black**  
HSC2-2W-FLT-30K-BK  
SKU: 666561425234

**Brushed Nickel**  
HSC2-2W-FLT-30K-BN  
SKU: 666561425210

**SOFT WHITE**  
2700K

**WARM WHITE**  
3000K



**Model: 3W-2C-SC**  
SKU: 666561406288

**Model: 2W-2C-SC**  
SKU: 666561406295

**Model: 3W-JB-M686**  
SKU: 666561434182

**3 Way Outdoor  
Screw Type Connector  
2 Contact**



**2 Way Outdoor  
Screw Type Connector  
2 Contact**



## ACCESSORIES (Sold Separately)

### Face Trims

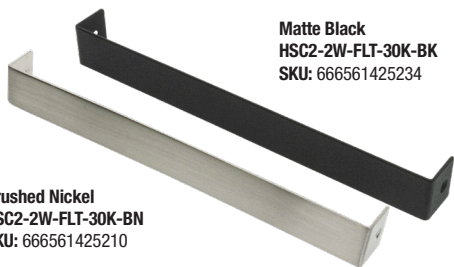

**Matte Black**  
HSC2-2W-FLT-30K-BK  
SKU: 666561425234

**Brushed Nickel**  
HSC2-2W-FLT-30K-BN  
SKU: 666561425210



**Model: 3W-YC-RGBW-M685**  
SKU: 666561434205

**Model: 3W-JB-M686**  
SKU: 666561434182

**3 Way Outdoor  
Screw Type Connector  
5 Contact (RGBW)**



To see all available controllers and remote controls, please scan the QR code with your smartphone.



### Disclaimer:

The data and information contained in this specification sheet are subject to change without notice; the ratings supplied are provided based on the product manufacturer. The information contained in this specification sheet should not be considered a warranty, expressed or implied, including, but not limited to, a warranty of merchantability or fitness for a particular purpose. In no event shall Veroboard be liable for any incidental or consequential damages resulting from the use, misuse, or inability to use the product. This exclusion applies regardless of whether such damages are sought based on breach of warranty, breach of contract, negligence, strict liability in tort, or any other legal theory.

For more information about our products and services, please visit our website: [www.veroboard.com](http://www.veroboard.com)

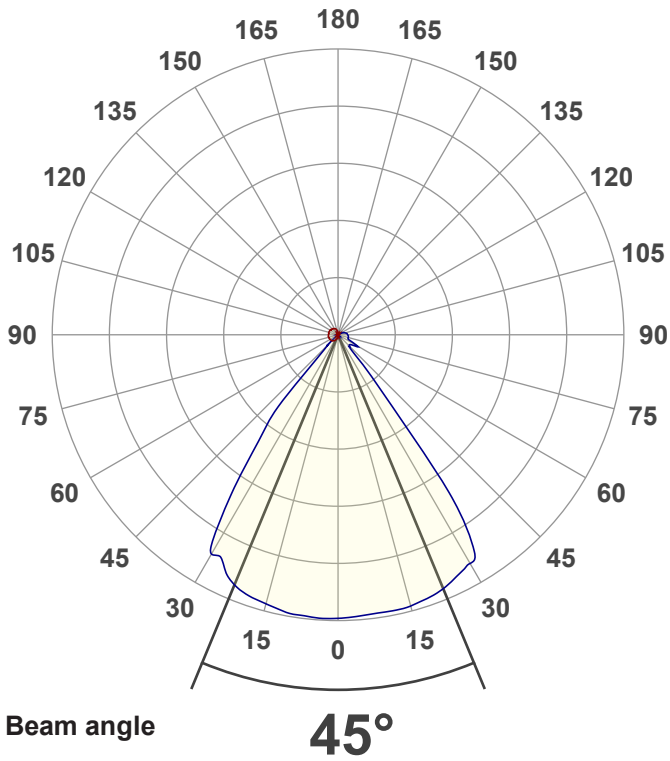

**WARM WHITE  
3000K**



**CIE 1931  
x: 0.437  
y: 0.404**

**Spectra**

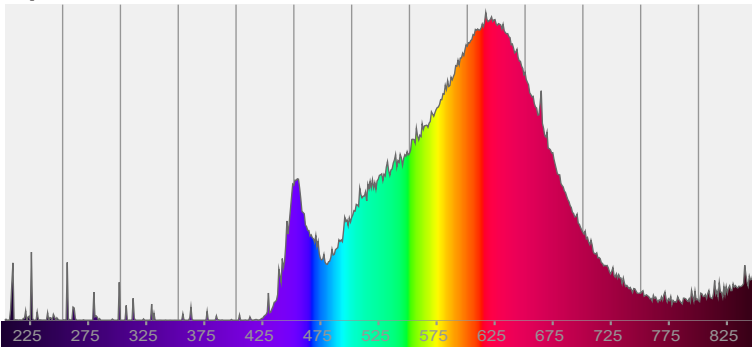

**Power**

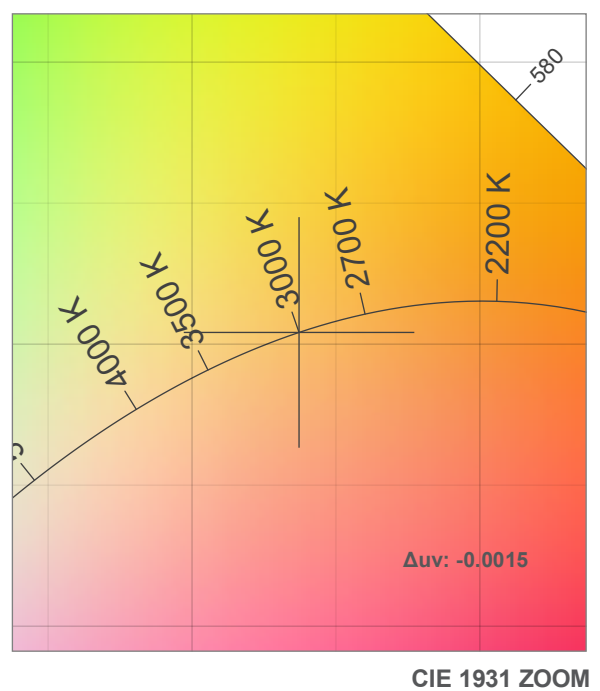
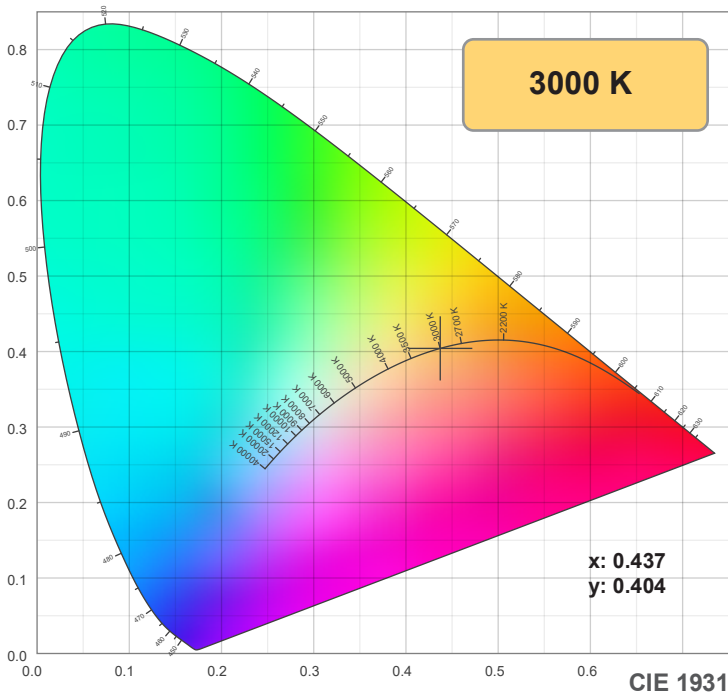
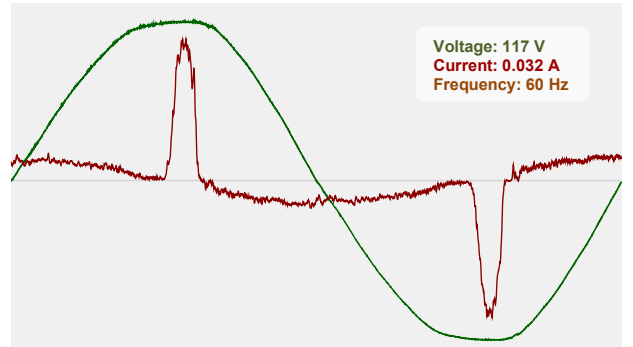

**TM-30: 91.9**

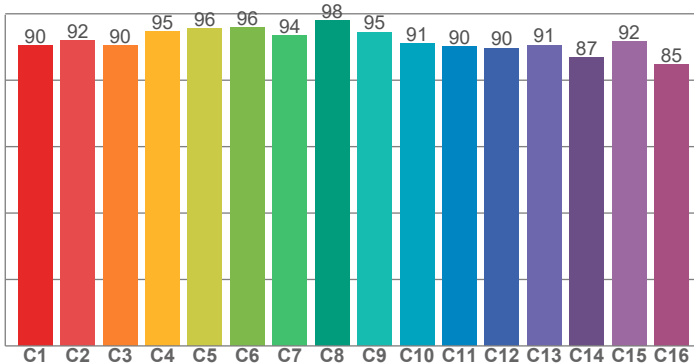

**CRI: 93.2 (R1-R8)**

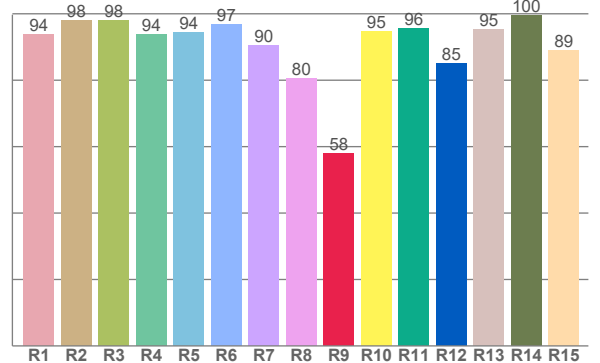

CRI R values, only R1-R8 are used to calculate final CRI value

R1	R2	R3	R4	R5	R6	R7	R8	R9	R10	R11	R12	R13	R14	R15
93.9	97.9	98.1	93.7	94.2	96.7	90.4	80.4	58.1	94.7	95.6	85.2	95.3	99.6	89.1

TM30 C values, 16 binned values out of total of 99 C values

C1	C2	C3	C4	C5	C6	C7	C8	C9	C10	C11	C12	C13	C14	C15	C16
90.5	92.0	90.5	94.6	95.5	95.9	93.5	98.0	94.5	91.1	90.1	89.7	90.6	86.8	91.7	84.8

CQS Q values

Q1	Q2	Q3	Q4	Q5	Q6	Q7	Q8	Q9	Q10	Q11	Q12	Q13	Q14	Q15
87.7	95.2	89.9	89.6	92.7	93.5	91.7	91.9	96.3	94.6	93.4	91.9	91.3	86.4	86.7

CQS: 90.9

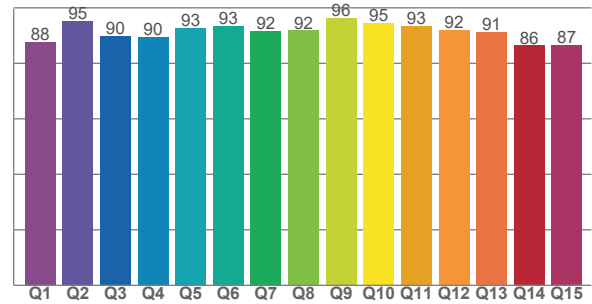

**Color parameters**

Color temperature	Color rendering index	Red component	Color fidelity	Color gamut	Color quality scale	Color coordinate cie 1931	Color coordinate cie 1931	Color coordinate	Color coordinate	Color deviation from black body
CCT	CRI	CRI R9	TM30 Rf	TM30 Rg	CQS	x	y	u	v	Δuv
3000 K	93.2	58.1	91.9	99.4	90.9	0.437	0.404	0.251	0.348	-0.0015

**Beam details**

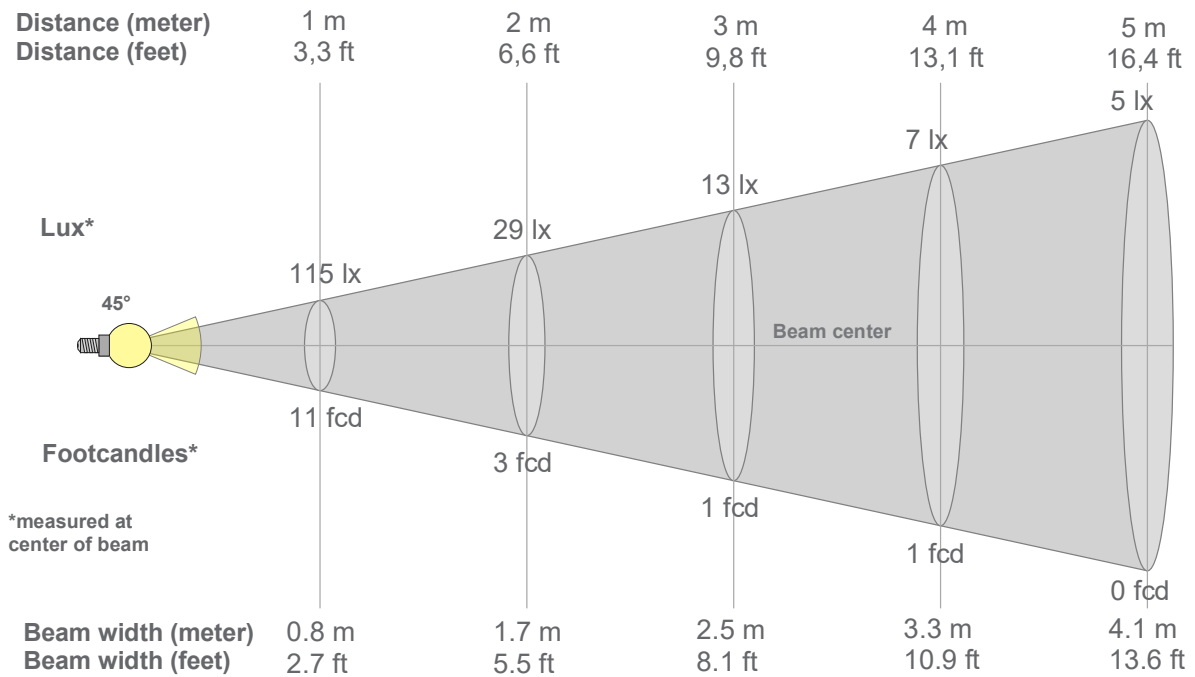

**Beam intensities from 1-20m**

1m	2m	3m	4m	5m	6m	7m	8m	9m	10m	11m	12m	13m	14m	15m	16m	17m	18m	19m	20m
3.3ft	6.6ft	9.8ft	13.1ft	16.4ft	19.7ft	23ft	26.2ft	29.5ft	32.8ft	36.1ft	39.4ft	42.7ft	45.9ft	49.2ft	52.5ft	55.8ft	59.1ft	62.3ft	65.6ft
115lx	29lx	13lx	7lx	5lx	3lx	2lx	2lx	1lx	1lx	1lx	1lx	1lx	1lx	1lx	0lx	0lx	0lx	0lx	0lx
10.7fcd	2.7fcd	1.2fcd	0.7fcd	0.4fcd	0.3fcd	0.2fcd	0.2fcd	0.1fcd	0.1fcd	0.1fcd	0.1fcd	0.1fcd	0.1fcd	0fcd	0fcd	0fcd	0fcd	0fcd	0fcd

**Intensities in 0° c-plane**

0°	9°	18°	27°	36°	45°	54°	63°	72°	81°	90°	99°	108°	117°	126°	135°	144°	153°	162°	171°	
115	0	0	0	0	0	0	0	0	0	0	0	0	0	0	0	0	0	0	1	1
100%	0%	0%	0%	0%	0%	0%	0%	0%	0%	0%	0%	0%	0%	0%	0%	0%	0%	0%	0%	1%

**Intensities in 90° c-plane**

0°	9°	18°	27°	36°	45°	54°	63°	72°	81°	90°	99°	108°	117°	126°	135°	144°	153°	162°	171°	
115	228	226	217	126	13	14	13	9	8	8	7	5	3	2	1	1	1	1	1	1
100%	198%	196%	189%	109%	12%	12%	11%	7%	7%	7%	6%	5%	3%	1%	1%	1%	1%	1%	1%	1%

**Intensities in 180° c-plane**

0°	9°	18°	27°	36°	45°	54°	63°	72°	81°	90°	99°	108°	117°	126°	135°	144°	153°	162°	171°	
115	2	3	5	6	7	7	8	8	8	8	7	8	7	7	7	6	5	4	3	3
100%	2%	3%	4%	5%	6%	6%	7%	7%	7%	7%	6%	7%	6%	6%	6%	5%	5%	4%	4%	2%

**Intensities in 270° c-plane**

0°	9°	18°	27°	36°	45°	54°	63°	72°	81°	90°	99°	108°	117°	126°	135°	144°	153°	162°	171°	
115	229	224	207	120	14	0	0	0	0	0	0	0	0	0	0	0	0	0	0	0
100%	199%	195%	180%	104%	12%	0%	0%	0%	0%	0%	0%	0%	0%	0%	0%	0%	0%	0%	0%	0%

Beam angle 50%	Field angle 10%	Cutoff angle 2,5%	Intensity ratio in 120° cone	Intensity ratio in 90° cone
45°	221.5°	257.1°	83.2%	78.8%