

Mini StarLite Series



These high-quality 3 Watt round ceiling lights are available in 4 different body colours, which brings more style to your home/office environment. 2-year in-store warranty is also included with the product.

RD24-3W-30K-WH

SKU: 666561415631

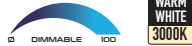

Model No:	RD24-3W-30K-WH
Voltage:	12V DC
Wattage:	3W
Colour Temperature:	3000K (Warm White)
Fixture Colour:	White
Housing Material:	Aluminum
Dimmable:	Yes
Dimensions:	Ø52mm x 44mm Depth (2.1in x 1.8in)
Cut Size:	Ø42mm (1.7in)



RD24-3W-30K-BK

SKU: 666561415617

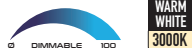

Model No:	RD24-3W-30K-BK
Voltage:	12V DC
Wattage:	3W
Colour Temperature:	3000K (Warm White)
Fixture Colour:	White
Housing Material:	Aluminum
Dimmable:	Yes
Dimensions:	Ø52mm x 44mm Depth (2.1in x 1.8in)
Cut Size:	Ø42mm (1.7in)



RD24-3W-30K-BN

SKU: 666561415624



Model No:	RD24-3W-30K-BN
Voltage:	12V DC
Wattage:	3W
Colour Temperature:	3000K (Warm White)
Fixture Colour:	White
Housing Material:	Aluminum
Dimmable:	Yes
Dimensions:	Ø52mm x 44mm Depth (2.1in x 1.8in)
Cut Size:	Ø42mm (1.7in)



RD24-3W-RGB-BN

SKU: 666561415648

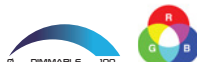

Model No:	RD24-3W-RGB-BN
Voltage:	12V DC
Wattage:	3W
Colour Temperature:	RGB
Fixture Colour:	White
Housing Material:	Aluminum
Dimmable:	Yes
Dimensions:	Ø52mm x 44mm Depth (2.1in x 1.8in)
Cut Size:	Ø42mm (1.7in)

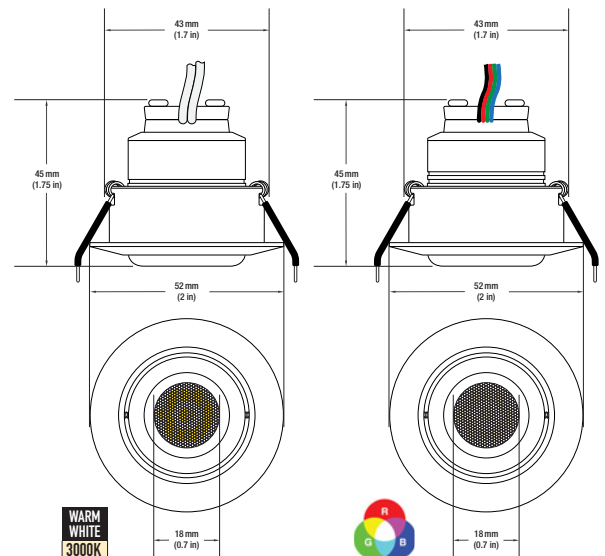

Disclaimer:

The data and information contained in this specification sheet are subject to change without notice; the ratings supplied are provided based on the product manufacturer. The information contained in this specification sheet should not be considered a warranty, expressed or implied, including, but not limited to, a warranty of merchantability or fitness for a particular purpose. In no event shall Veroboard be liable for any incidental or consequential damages resulting from the use, misuse, or inability to use the product. This exclusion applies regardless of whether such damages are sought based on breach of warranty, breach of contract, negligence, strict liability in tort, or any other legal theory.



New Construction Universal Mounting Plate

(Sold separately)

New Construction Universal Mounting Plate suitable for 2, 3, 3.5, and 5-inch sizes, with two hanger bars.

Model: **MP-UNV-23345** | SKU: **666561433802**

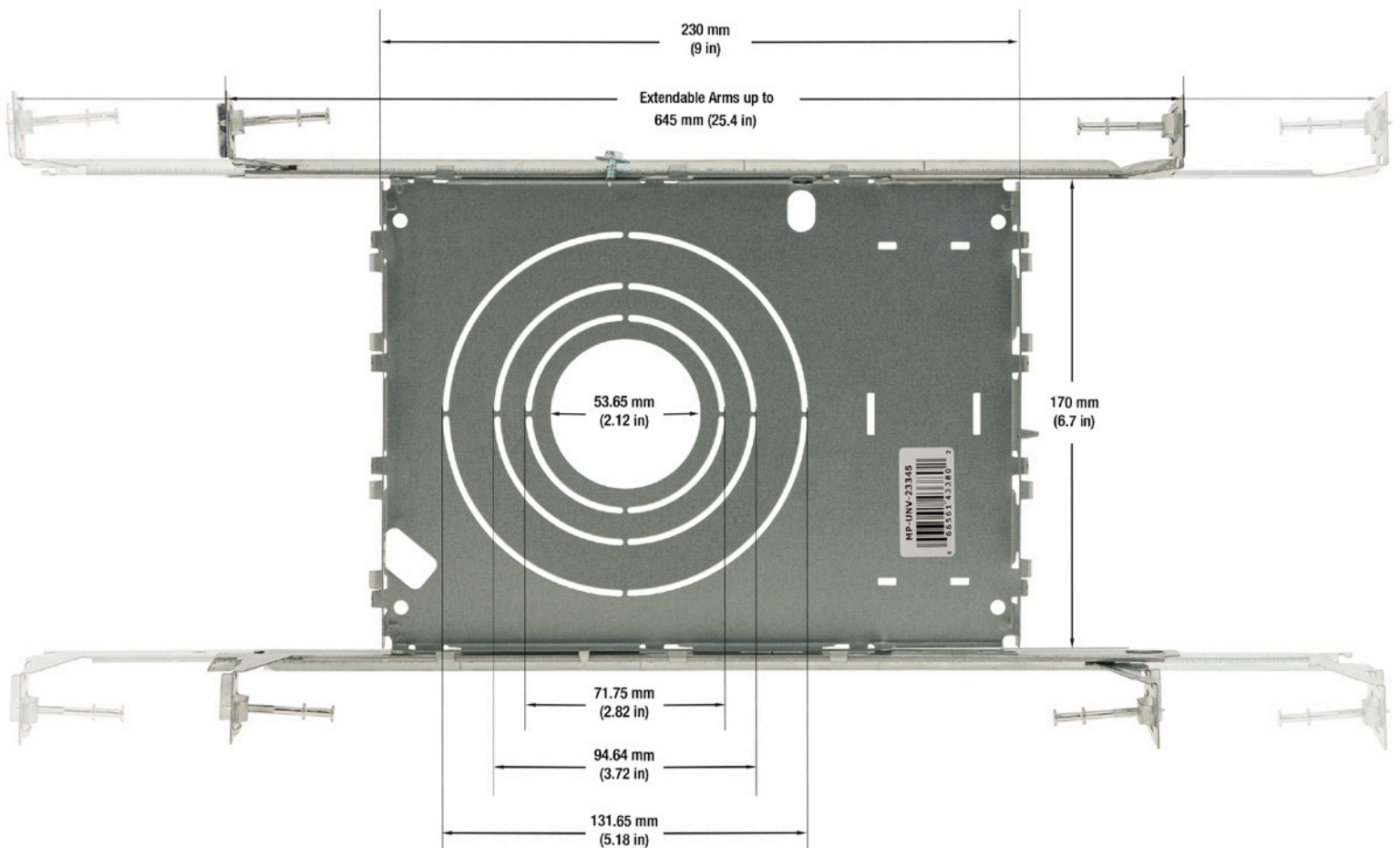
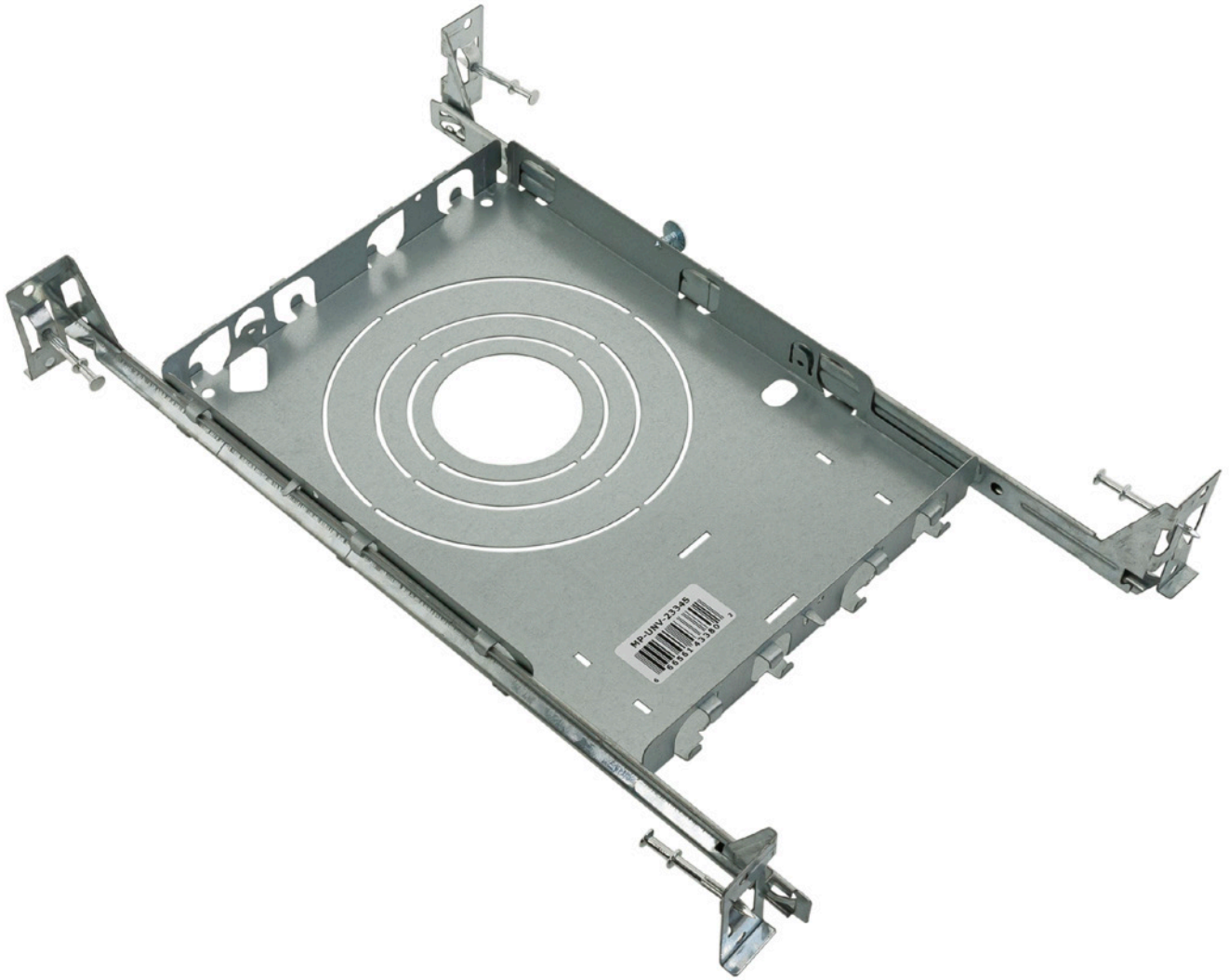

Light Measurement Report

Print date: 2023-01-26

Measurement date and time: 2023-01-25 3:08:55 PM – Measurement no. VFR-230125-0002-MS

Luminous Intensity diagram

Unit: 0-100% of peak intensity

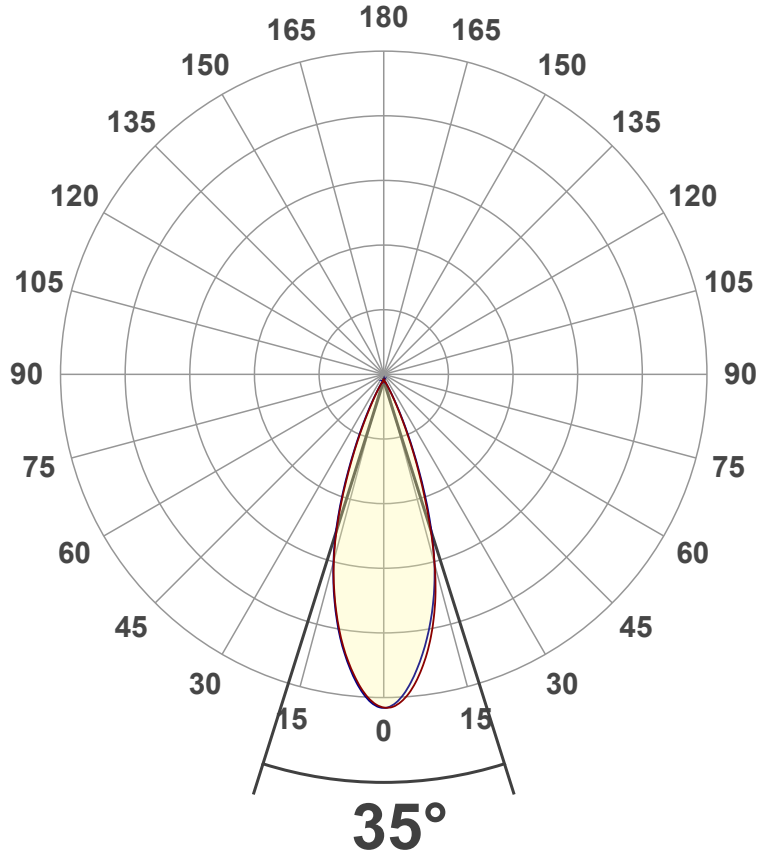

Main Values

Output (total Lumen)	210 lm
Lumen Up% / Down%	0.03% / 99.97%
Peak Intensity	580 cd
Beam Angle (50%)	35°
Beam Angle (90%)	35.1°
Beam Angle (10%)	34.7°

Cut-off Angle

Average 2,5%	70.3°
--------------	-------

Field Angle

Average 10%	55°
-------------	-----

Intensity Ratio

In 120° cone	99.1%
In 90° cone	96.9%

C000-C180
C090-C270

Linear distribution diagram - Intensity (candela) vs γ -angle

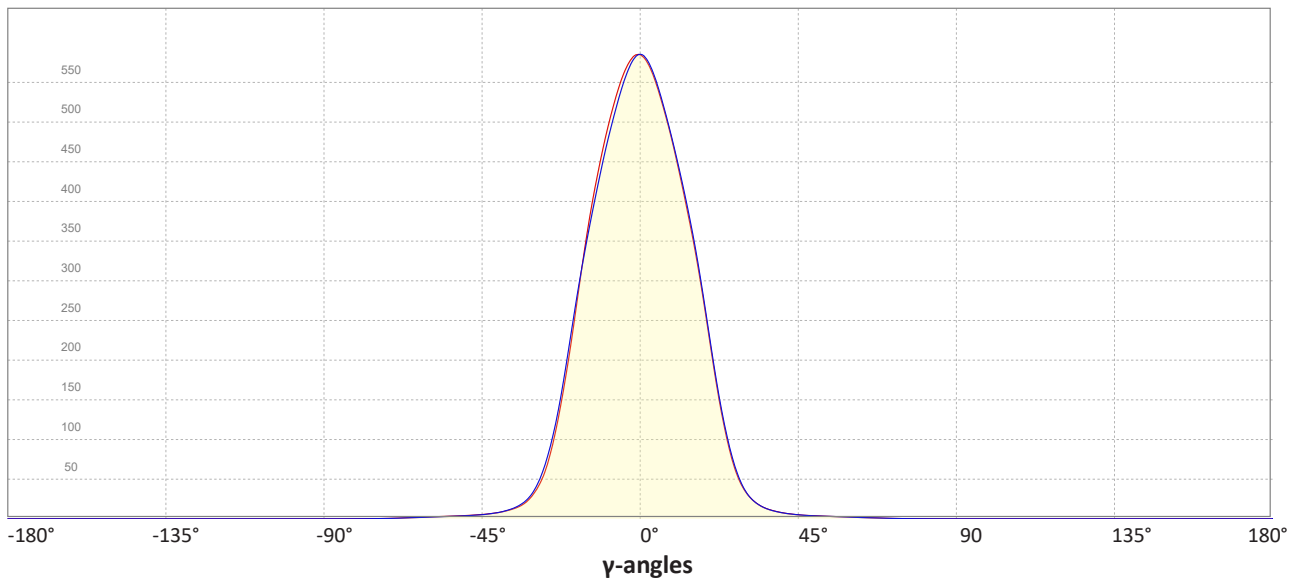

Light Measurement Report

Print date: 2023-01-26

Measurement date and time: 2023-01-25 3:08:55 PM – Measurement no. VFR-230125-0002-MS

Color details

Correlated Color Temperature, Target CCT = 3000 K
 Correlated Color Temperature, Measured CCT = 3076 K
 Color Rendering Index CRI 83.0
 Color Rendering Index, R9 (red component) R9 = 17.8
 Color Rendering TM30-18 R_f 80.3 – R_g 102.3
 Color Quality Scale CQS = 79.9

MacAdam Steps
 Color coordinates CIE 1931 (x;y) = (0.437;0.404)
 Color coordinate CIEs 1960 (u;v) = (0.251;0.348)
 Color deviation from BBL Duv = -0.0037
 Color coordinate CIEs 1976 (CIELUV) (u';v') = (0.251;0.251)

CIE 1931

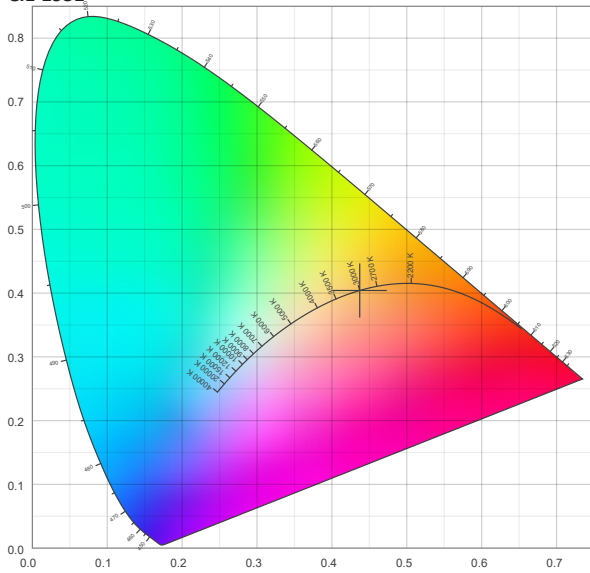

CIE 1931 – zoomed on Planckian locus

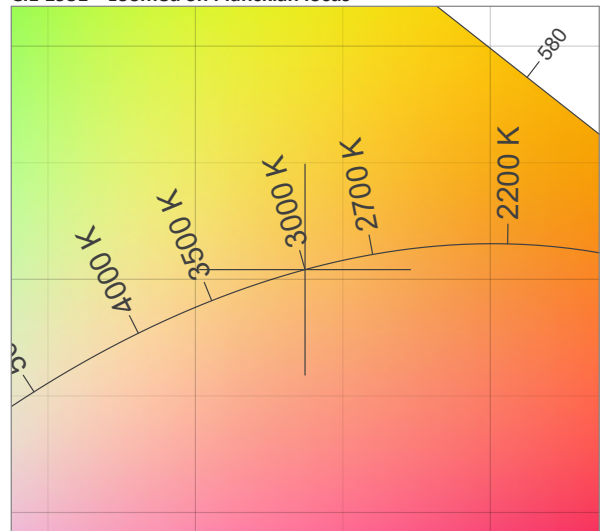

Color Rendering Index per reference color (CIE 1995)

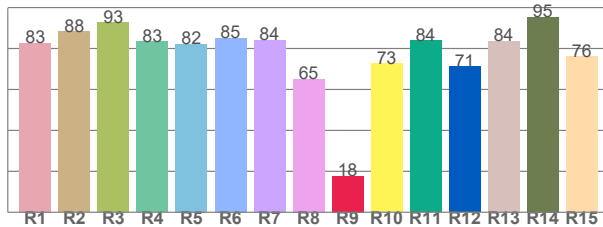

CRI R values, only R1-R8 are used to calculate final CRI value

R1	R2	R3	R4	R5	R6	R7	R8	R9	R10	R11	R12	R13	R14	R15
82.7	88.3	92.8	83.3	82.3	85.2	84.2	65.1	17.8	72.7	84.0	71.3	83.6	95.5	76.2

Spectral power distribution (SPD) / W/nm – 0-100%

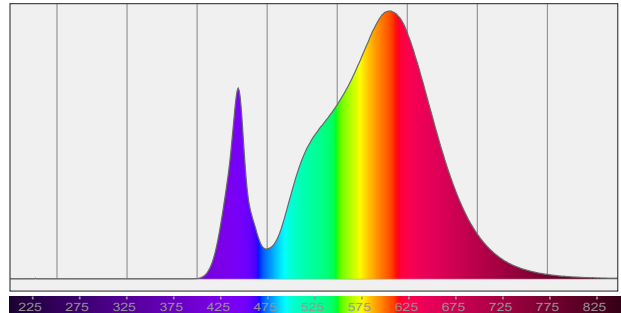

TM30-18 Rf-values per hue bin

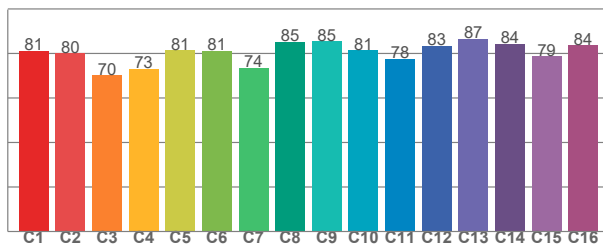

TM30 C values, 16 binned values out of total of 99 C values

C1	C2	C3	C4	C5	C6	C7	C8	C9	C10	C11	C12	C13	C14	C15	C16
81.3	80.1	70.1	73.1	81.5	81.2	73.6	85.2	85.5	81.5	77.7	83.5	86.7	84.5	78.8	83.7

Color Quality Scale by reference color

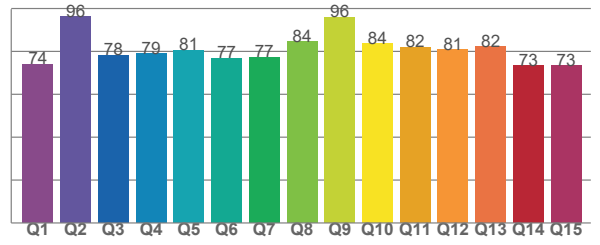

CQS Q values

Q1	Q2	Q3	Q4	Q5	Q6	Q7	Q8	Q9	Q10	Q11	Q12	Q13	Q14	Q15
74.0	96.1	78.1	78.8	80.5	76.8	77.3	84.5	96.0	83.6	81.8	80.8	82.1	73.3	73.3

Light Measurement Report

Print date: 2023-01-26

Measurement date and time: 2023-01-25 3:08:55 PM – Measurement no. VFR-230125-0002-M5

Beam Details

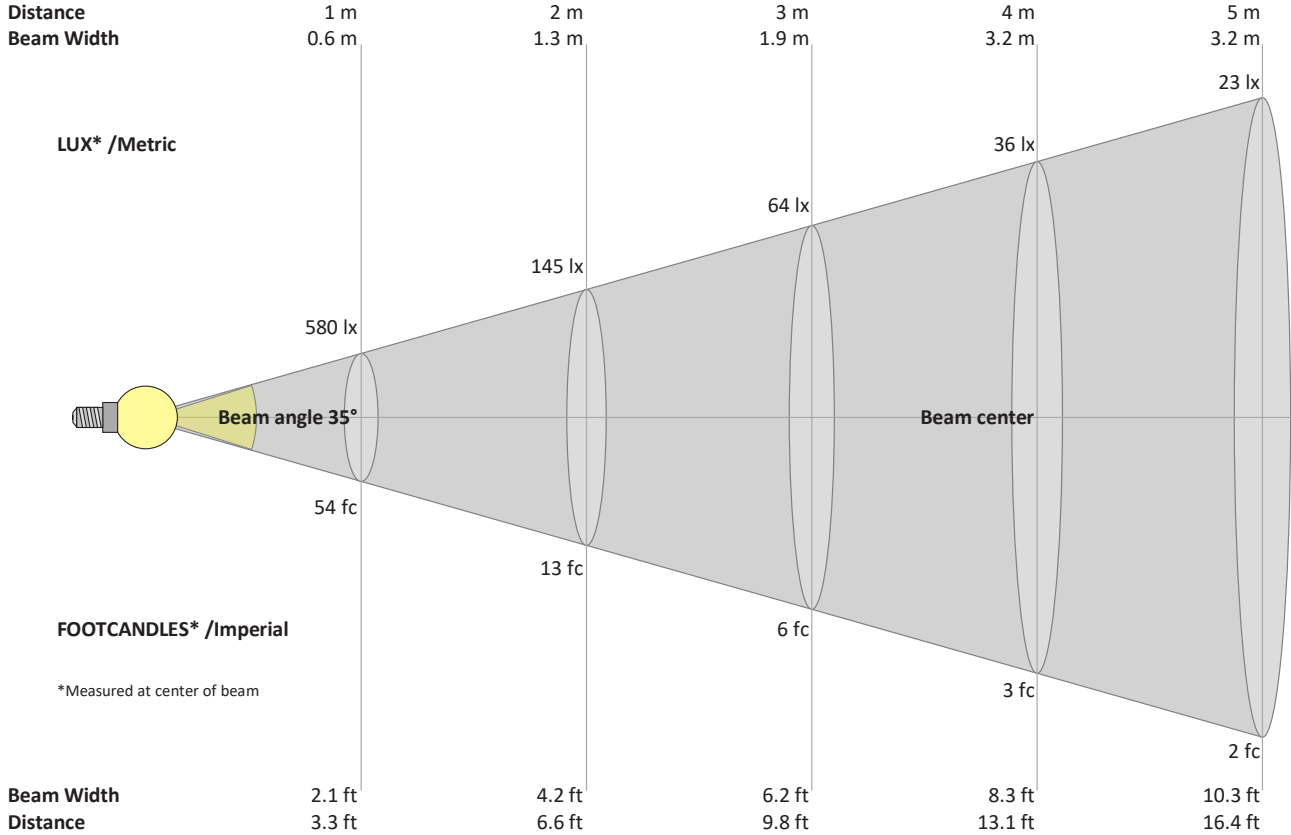

Beam intensities from 1 – 20 m

1	2	3	4	5	6	7	8	9	10	11	12	13	14	15	16	17	18	19	20	m
3.3	6.6	9.8	13.1	16.4	19.7	23	26.2	29.5	32.8	36.1	39.4	42.7	45.9	49.2	52.5	55.8	59.1	62.3	65.6	ft
580	145	64	36	23	16	12	9	7	6	5	4	3	3	3	2	2	2	2	1	lux
53.9	13.5	6	3.4	2.2	1.5	1.1	0.8	0.7	0.5	0.4	0.4	0.3	0.3	0.2	0.2	0.2	0.2	0.1	0.1	fc

Intensities in 0° c-plane

0°	2°	4°	6°	8°	10°	12°	14°	16°	18°	20°	22°	24°	26°	28°	30°	32°	34°	36°	38°	y
580	577	563	540	510	474	433	386	331	271	211	157	111	75	50	33	23	17	13	10	cd
100%	100%	97%	93%	88%	82%	75%	67%	57%	47%	36%	27%	19%	13%	9%	6%	4%	3%	2%	2%	of 0°val

Intensities in 90° c-plane

0°	2°	4°	6°	8°	10°	12°	14°	16°	18°	20°	22°	24°	26°	28°	30°	32°	34°	36°	38°	y
580	573	554	526	494	458	419	377	331	277	220	165	118	80	53	35	24	17	13	10	cd
100%	99%	96%	91%	85%	79%	72%	65%	57%	48%	38%	28%	20%	14%	9%	6%	4%	3%	2%	2%	of 0°val

Intensities in 180° c-plane

0°	2°	4°	6°	8°	10°	12°	14°	16°	18°	20°	22°	24°	26°	28°	30°	32°	34°	36°	38°	y
580	570	550	523	491	455	415	372	326	273	216	161	114	77	51	34	24	17	13	10	cd
100%	98%	95%	90%	85%	78%	72%	64%	56%	47%	37%	28%	20%	13%	9%	6%	4%	3%	2%	2%	of 0°val

Intensities in 270° c-plane

0°	2°	4°	6°	8°	10°	12°	14°	16°	18°	20°	22°	24°	26°	28°	30°	32°	34°	36°	38°	y
580	573	554	527	494	459	418	375	328	277	222	168	121	84	56	37	25	18	14	10	cd
100%	99%	96%	91%	85%	79%	72%	65%	57%	48%	38%	29%	21%	15%	10%	6%	4%	3%	2%	2%	of 0°val