

Job Name: _____

Distributor: _____

Type: _____

VBD-MTR-10B Light Fixture 2.5" Round Recessed Downlight

SPECIFICATIONS



Model No.	VBD-MTR-10B
Trim Color	White with Black interior finish
Trim Material	Aluminum
Trim Shape	Round
Compatible Light Engines	VBD-TR5-W (2400K • 2700K • 3000K • 3500K • 4000K • 5000K) VBD-TR4-RGBW
Outer Diameter	88.24mm (3.47")
Cut Size	65.45mm (2.5")
Depth	31.4mm (1.23")

SKU: 666561407322

Features

- Widely used by interior designers.
- This VBD-MTR-10B light fixture is compatible to work with our VBD-TR Series Light engines.
- Contact us for more assistance and to know more about bulk orders.

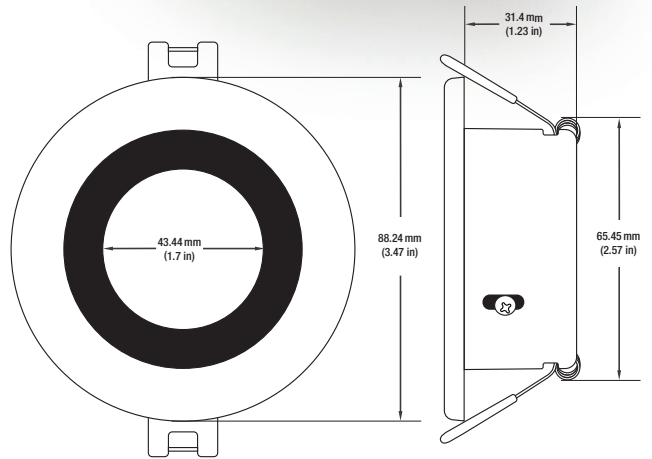

VBD-TR5-W (Frosted Glass)

Model No.	VBD-TR5-W-FG
Input Voltage	12V DC
Wattage	5W
Body Colour	Metallic Silver
Available Trim Color	Silver • White • Black • Gold
Diffuser Material	Frosted Glass
Fixture Material	Aluminum
Beam Angle	110°
Rendering Index	CRI>90
IP Rating	IP20 (Damp Location)
Dimensions	49mm x 28.5mm (1.93" x 1.12")

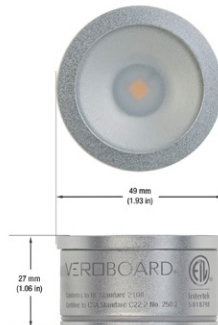

Beam Details

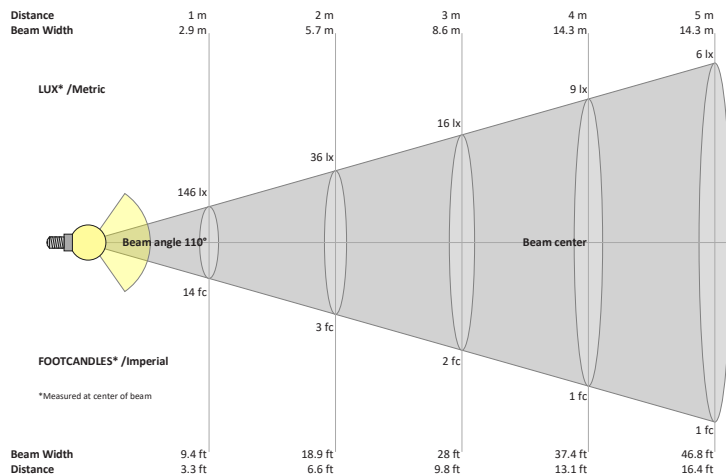

Available Colour Temperatures

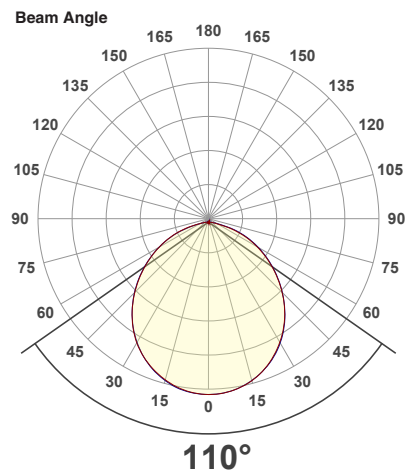

ORDERING GUIDE

Example part number: **VBD-TR5-W-FG-24K-S**

MODEL	SERIES	DIFFUSER	COLOUR	TRIM COLOUR
VBD	TR5-W	FG	24K 35K 27K 40K 30K 50K	S B G W

NOTES:
 FG = Frosted Glass
 S = Silver
 G = Gold
 B = Black
 W = White



VBD-TR5-W (Clear Lens)

Model No.	VBD-TR5-W-L
Input Voltage	12V DC
Wattage	5W
Body Colour	Metallic Silver
Available Trim Color	Silver • White • Black • Gold
Diffuser Material	Clear Lens
Fixture Material	Aluminum
Beam Angle	35°
Rendering Index	CRI>90
IP Rating	IP20 (Damp Location)
Dimensions	49mm x 28.5mm (1.93" x 1.12")



Available Colour Temperatures



Beam Details



Beam Angle

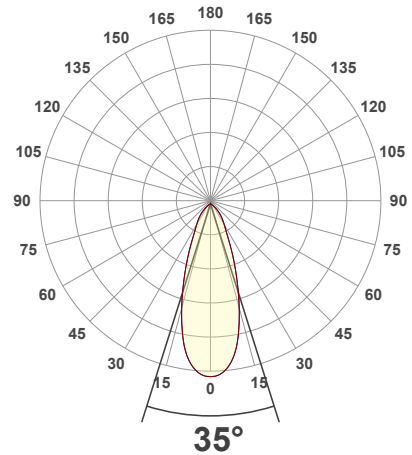

ORDERING GUIDE

Example part number: **VBD-TR5-W-L-24K-S**



NOTES:

L = Clear Lens
S = Silver
G = Gold
B = Black
W = White



VBD-TR4-RGBW (Frosted Glass)

Model No.	VBD-TR4-RGBW-FG
Input Voltage	12V DC
Wattage	4W
Color Temperature	RGBW
Body Colour	Metallic Silver
Available Trim Color	Silver • White • Black • Gold
Diffuser Material	Frosted Glass
Fixture Material	Aluminum
Beam Angle	110°
Rendering Index	CRI>80
IP Rating	IP20 (Damp Location)
Dimensions	49mm x 28.5mm (1.93" x 1.12")

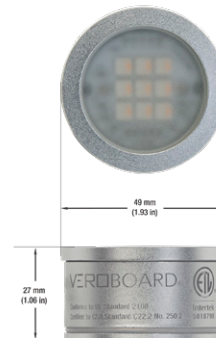

Beam Details



Beam Angle

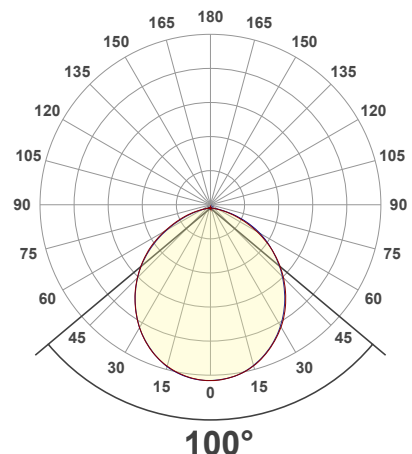

ORDERING GUIDE

Example part number: **VBD-TR4-RGBW-FG-S**

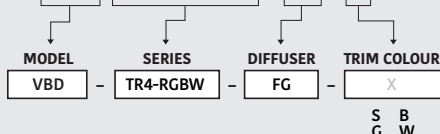

NOTES:

FG = Frosted Glass
S = Silver
G = Gold
B = Black
W = White



AVAILABLE TRIM MODELS



MODEL No. VBD-MTR-1C



MODEL No. VBD-MTR-1W



MODEL No. VBD-MTR-13C



MODEL No. VBD-MTR-13W



MODEL No. VBD-MTR-13B



MODEL No. VBD-MTR-12C



MODEL No. VBD-MTR-12W

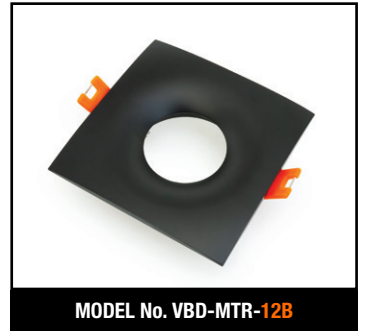

MODEL No. VBD-MTR-12B



MODEL No. VBD-MTR-11C



MODEL No. VBD-MTR-11W



MODEL No. VBD-MTR-11B



MODEL No. VBD-MTR-9C



MODEL No. VBD-MTR-9W



MODEL No. VBD-MTR-9B



MODEL No. VBD-MTR-7C



MODEL No. VBD-MTR-7W



MODEL No. VBD-MTR-14C



MODEL No. VBD-MTR-14W



MODEL No. VBD-MTR-14B

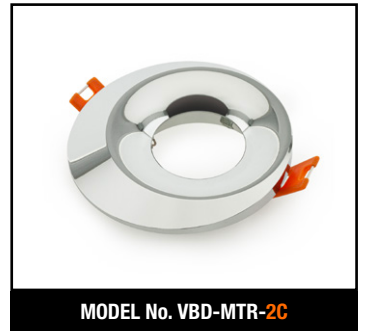

MODEL No. VBD-MTR-2C



MODEL No. VBD-MTR-2W



MODEL No. VBD-MTR-8C



MODEL No. VBD-MTR-8W



MODEL No. VBD-MTR-8B



MODEL No. VBD-MTR-5C



MODEL No. VBD-MTR-5W

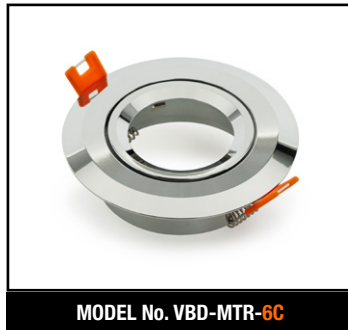

MODEL No. VBD-MTR-6C



MODEL No. VBD-MTR-6W

AVAILABLE TRIM MODELS



MODEL No. VBD-MTR-3C



MODEL No. VBD-MTR-3W

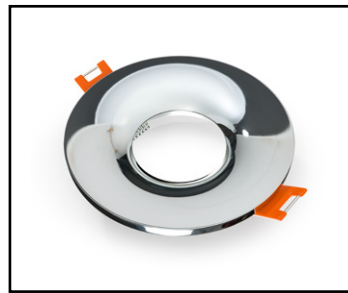

MODEL No. VBD-MTR-4C



MODEL No. VBD-MTR-4W



MODEL No. VBD-MTR-16C



MODEL No. VBD-MTR-16W



MODEL No. VBD-MTR-10W



MODEL No. VBD-MTR-10B



MODEL No. VBD-MTR-54T



MODEL No. VBD-MTR-59T

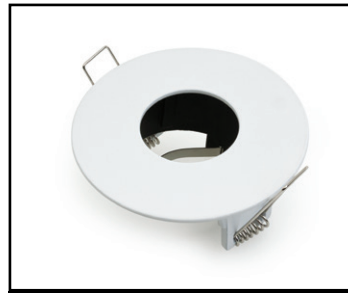

MODEL No. VBD-MTR-60T



MODEL No. VBD-MTR-65T



MODEL No. VBD-MTR-67T



MODEL No. VBD-MTR-70T



MODEL No. VBD-MTR-75T



MODEL No. VBD-MTR-76T



MODEL No. VBD-MTR-73T



MODEL No. VBD-MTR-74T



MODEL No. VBD-MTR-77T



MODEL No. VBD-MTR-78T



MODEL No. VBD-MTR-17-1W



MODEL No. VBD-MTR-17C



MODEL No. VBD-MTR-79W



MODEL No. VBD-MTR-80W



MODEL No. VBD-MTR-81W



MODEL No. VBD-MTR-82W



MODEL No. VBD-MTR-83W



MODEL No. VBD-MTR-84W

