

Job Name: _____

Distributor: _____

Type: _____

VBD-MTR-8W Light Fixture 2.5" Round Recessed Downlight

SPECIFICATIONS



Model No.	VBD-MTR-8W
Trim Color	White
Trim Material	Aluminum
Trim Shape	Round
Compatible Light Engines	VBD-TR5-W (2400K • 2700K • 3000K • 3500K • 4000K • 5000K) VBD-TR4-RGBW
Outer Diameter	98mm (3.85")
Cut Size	64.83mm (2.5")
Depth	20.48mm (0.8")



SKU: 666561407285

Features

- Widely used by interior designers.
- This VBD-MTR-8W light fixture is compatible to work with our VBD-TR Series Light engines.
- Contact us for more assistance and to know more about bulk orders.

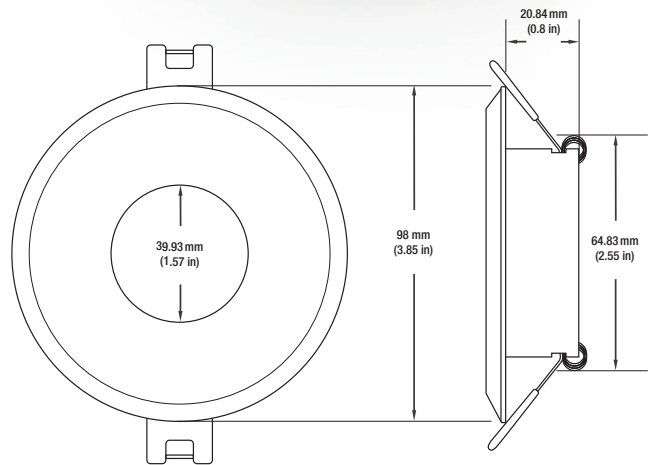

VBD-TR5-W (Frosted Glass)

Model No.	VBD-TR5-W-FG
Input Voltage	12V DC
Wattage	5W
Body Colour	Metallic Silver
Available Trim Color	Silver • White • Black • Gold
Diffuser Material	Frosted Glass
Fixture Material	Aluminum
Beam Angle	110°
Rendering Index	CRI>90
IP Rating	IP20 (Damp Location)
Dimensions	49mm x 28.5mm (1.93" x 1.12")

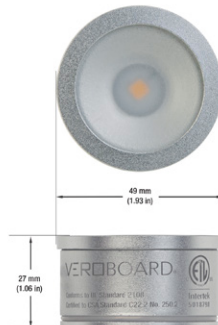

Beam Details

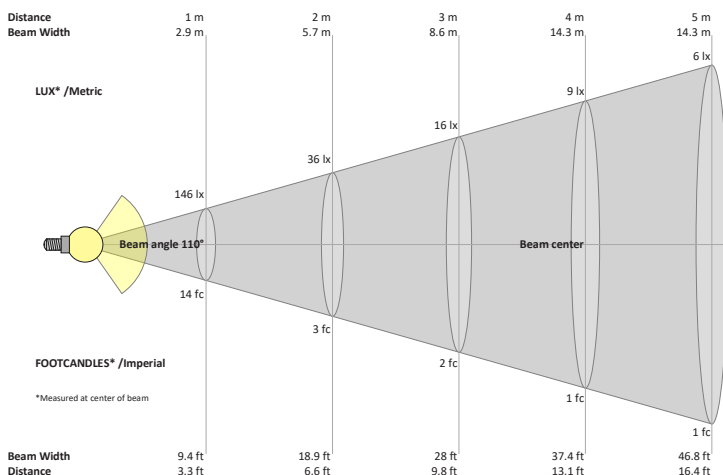

Available Colour Temperatures

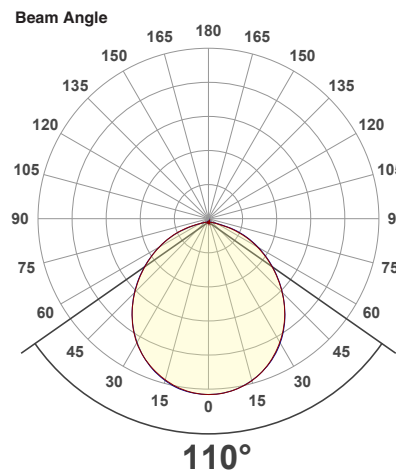

ORDERING GUIDE

Example part number: **VBD-TR5-W-FG-24K-S**

MODEL	SERIES	DIFFUSER	COLOUR	TRIM COLOUR
VBD	TR5-W	FG	24K 35K 27K 40K 30K 50K	S B G W

NOTES:
FG = Frosted Glass
S = Silver
G = Gold
B = Black
W = White



VBD-TR5-W (Clear Lens)

Model No.	VBD-TR5-W-L
Input Voltage	12V DC
Wattage	5W
Body Colour	Metallic Silver
Available Trim Color	Silver • White • Black • Gold
Diffuser Material	Clear Lens
Fixture Material	Aluminum
Beam Angle	35°
Rendering Index	CRI>90
IP Rating	IP20 (Damp Location)
Dimensions	49mm x 28.5mm (1.93" x 1.12")



Available Colour Temperatures



Beam Details



Beam Angle

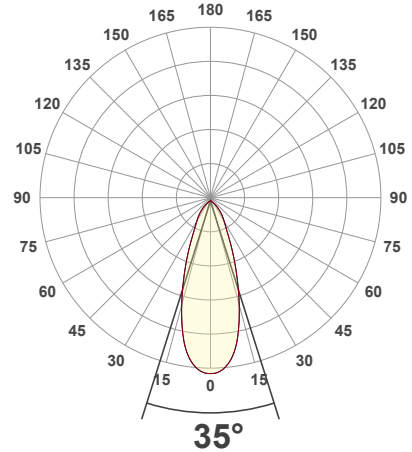

ORDERING GUIDE

Example part number: **VBD-TR5-W-L-24K-S**

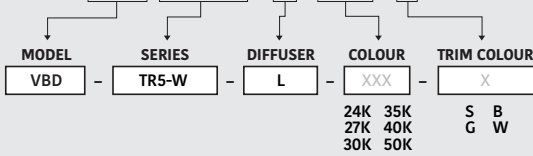

NOTES:

L = Clear Lens
 S = Silver
 G = Gold
 B = Black
 W = White



VBD-TR4-RGBW (Frosted Glass)

Model No.	VBD-TR4-RGBW-FG
Input Voltage	12V DC
Wattage	4W
Color Temperature	RGBW
Body Colour	Metallic Silver
Available Trim Color	Silver • White • Black • Gold
Diffuser Material	Frosted Glass
Fixture Material	Aluminum
Beam Angle	110°
Rendering Index	CRI>80
IP Rating	IP20 (Damp Location)
Dimensions	49mm x 28.5mm (1.93" x 1.12")

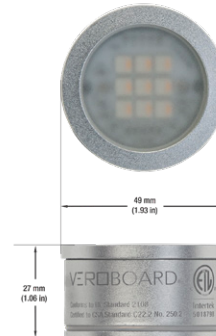

Beam Details



Beam Angle

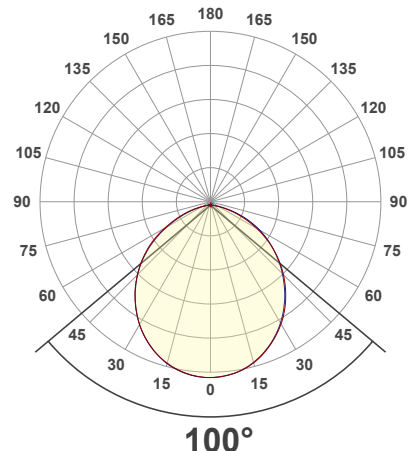

ORDERING GUIDE

Example part number: **VBD-TR4-RGBW-FG-S**











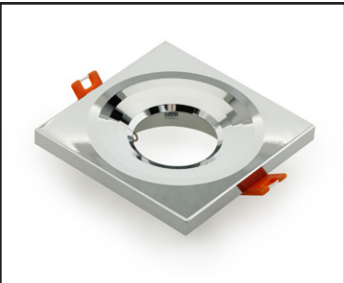

NOTES:

FG = Frosted Glass
 S = Silver
 G = Gold
 B = Black
 W = White



AVAILABLE TRIM MODELS

 <p>MODEL No. VBD-MTR-1C</p>	 <p>MODEL No. VBD-MTR-1W</p>	 <p>MODEL No. VBD-MTR-13C</p>	 <p>MODEL No. VBD-MTR-13W</p>
 <p>MODEL No. VBD-MTR-13B</p>	 <p>MODEL No. VBD-MTR-12C</p>	 <p>MODEL No. VBD-MTR-12W</p>	 <p>MODEL No. VBD-MTR-12B</p>
 <p>MODEL No. VBD-MTR-11C</p>	 <p>MODEL No. VBD-MTR-11W</p>	 <p>MODEL No. VBD-MTR-11B</p>	 <p>MODEL No. VBD-MTR-9C</p>
 <p>MODEL No. VBD-MTR-9W</p>	 <p>MODEL No. VBD-MTR-9B</p>	 <p>MODEL No. VBD-MTR-7C</p>	 <p>MODEL No. VBD-MTR-7W</p>
 <p>MODEL No. VBD-MTR-14C</p>	 <p>MODEL No. VBD-MTR-14W</p>	 <p>MODEL No. VBD-MTR-14B</p>	 <p>MODEL No. VBD-MTR-2C</p>
 <p>MODEL No. VBD-MTR-2W</p>	 <p>MODEL No. VBD-MTR-8C</p>	 <p>MODEL No. VBD-MTR-8W</p>	 <p>MODEL No. VBD-MTR-8B</p>
 <p>MODEL No. VBD-MTR-5C</p>	 <p>MODEL No. VBD-MTR-5W</p>	 <p>MODEL No. VBD-MTR-6C</p>	 <p>MODEL No. VBD-MTR-6W</p>

AVAILABLE TRIM MODELS



MODEL No. VBD-MTR-3C



MODEL No. VBD-MTR-3W

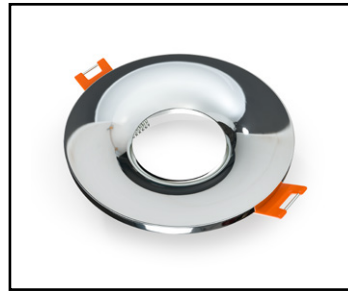

MODEL No. VBD-MTR-4C



MODEL No. VBD-MTR-4W



MODEL No. VBD-MTR-16C



MODEL No. VBD-MTR-16W



MODEL No. VBD-MTR-10W



MODEL No. VBD-MTR-10B



MODEL No. VBD-MTR-54T



MODEL No. VBD-MTR-59T



MODEL No. VBD-MTR-60T



MODEL No. VBD-MTR-65T



MODEL No. VBD-MTR-67T



MODEL No. VBD-MTR-70T



MODEL No. VBD-MTR-75T



MODEL No. VBD-MTR-76T



MODEL No. VBD-MTR-73T



MODEL No. VBD-MTR-74T



MODEL No. VBD-MTR-77T



MODEL No. VBD-MTR-78T



MODEL No. VBD-MTR-17-1W



MODEL No. VBD-MTR-17C



MODEL No. VBD-MTR-79W



MODEL No. VBD-MTR-80W



MODEL No. VBD-MTR-81W



MODEL No. VBD-MTR-82W



MODEL No. VBD-MTR-83W



MODEL No. VBD-MTR-84W

