

Job Name: _____

Distributor: _____

Type: _____

VBD-MTR-14W Light Fixture 2.5" Round Recessed Downlight

SPECIFICATIONS



Model No.	VBD-MTR-14W
Trim Color	White
Trim Material	Aluminum
Trim Shape	Round
Compatible Light Engines	VBD-TR5-W (2400K • 2700K • 3000K • 3500K • 4000K • 5000K) VBD-TR4-RGBW
Outer Diameter	98mm (3.85")
Cut Size	64.83mm (2.5")
Depth	16mm (0.62")

SKU: 666561407117

Features

- Widely used by interior designers.
- This VBD-MTR-14W light fixture is compatible to work with our VBD-TR Series Light engines.
- Contact us for more assistance and to know more about bulk orders.

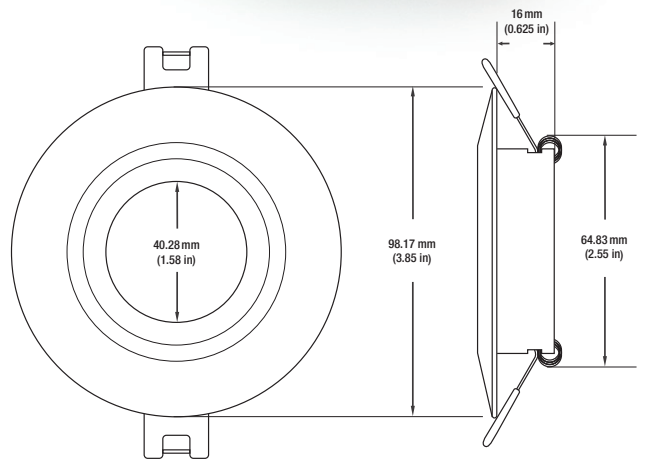

VBD-TR5-W (Frosted Glass)

Model No.	VBD-TR5-W-FG
Input Voltage	12V DC
Wattage	5W
Body Colour	Metallic Silver
Available Trim Color	Silver • White • Black • Gold
Diffuser Material	Frosted Glass
Fixture Material	Aluminum
Beam Angle	110°
Rendering Index	CRI>90
IP Rating	IP20 (Damp Location)
Dimensions	49mm x 28.5mm (1.93" x 1.12")



Beam Details

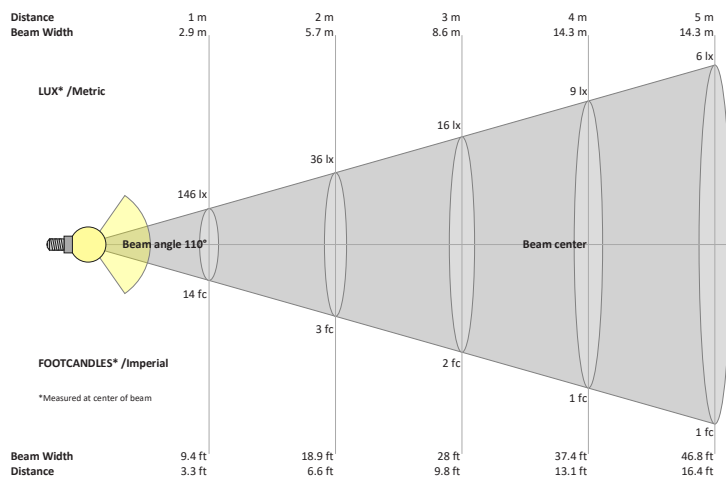

Available Colour Temperatures

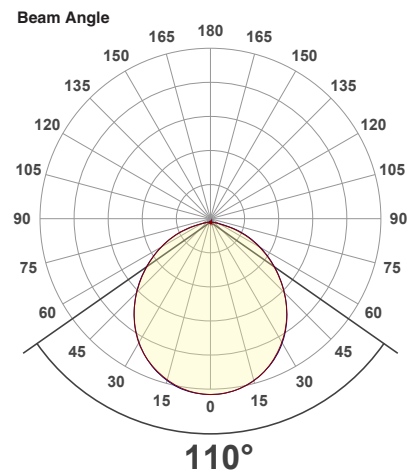

ORDERING GUIDE

Example part number: **VBD-TR5-W-FG-24K-S**

MODEL	SERIES	DIFFUSER	COLOUR	TRIM COLOUR
VBD	TR5-W	FG	XXX	X
			24K 35K 27K 40K 30K 50K	S B G W

NOTES:
 FG = Frosted Glass
 S = Silver
 G = Gold
 B = Black
 W = White

VBD-TR5-W (Clear Lens)

Model No.	VBD-TR5-W-L
Input Voltage	12V DC
Wattage	5W
Body Colour	Metallic Silver
Available Trim Color	Silver • White • Black • Gold
Diffuser Material	Clear Lens
Fixture Material	Aluminum
Beam Angle	35°
Rendering Index	CRI>90
IP Rating	IP20 (Damp Location)
Dimensions	49mm x 28.5mm (1.93" x 1.12")



Available Colour Temperatures



Beam Details



Beam Angle

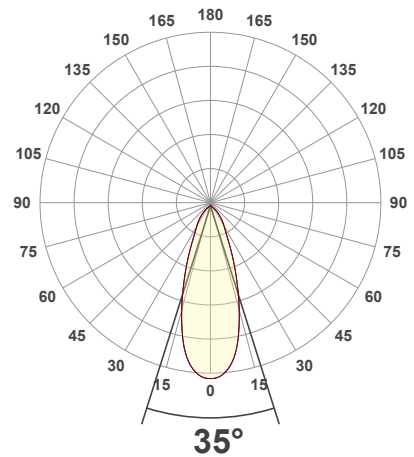

ORDERING GUIDE

Example part number: **VBD-TR5-W-L-24K-S**



NOTES:

L = Clear Lens
S = Silver
G = Gold
B = Black
W = White



VBD-TR4-RGBW (Frosted Glass)

Model No.	VBD-TR4-RGBW-FG
Input Voltage	12V DC
Wattage	4W
Color Temperature	RGBW
Body Colour	Metallic Silver
Available Trim Color	Silver • White • Black • Gold
Diffuser Material	Frosted Glass
Fixture Material	Aluminum
Beam Angle	110°
Rendering Index	CRI>80
IP Rating	IP20 (Damp Location)
Dimensions	49mm x 28.5mm (1.93" x 1.12")

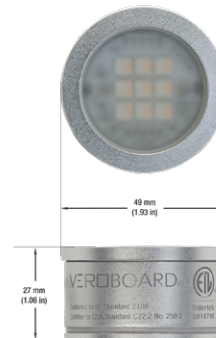

Beam Details



Beam Angle

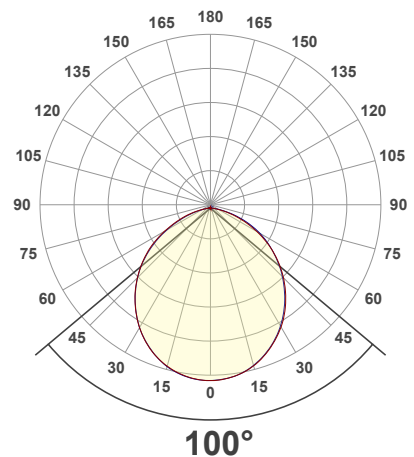

ORDERING GUIDE

Example part number: **VBD-TR4-RGBW-FG-S**

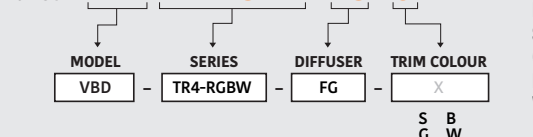

NOTES:

FG = Frosted Glass
S = Silver
G = Gold
B = Black
W = White



AVAILABLE TRIM MODELS

 <p>MODEL No. VBD-MTR-1C</p>	 <p>MODEL No. VBD-MTR-1W</p>	 <p>MODEL No. VBD-MTR-13C</p>	 <p>MODEL No. VBD-MTR-13W</p>
 <p>MODEL No. VBD-MTR-13B</p>	 <p>MODEL No. VBD-MTR-12C</p>	 <p>MODEL No. VBD-MTR-12W</p>	 <p>MODEL No. VBD-MTR-12B</p>
 <p>MODEL No. VBD-MTR-11C</p>	 <p>MODEL No. VBD-MTR-11W</p>	 <p>MODEL No. VBD-MTR-11B</p>	 <p>MODEL No. VBD-MTR-9C</p>
 <p>MODEL No. VBD-MTR-9W</p>	 <p>MODEL No. VBD-MTR-9B</p>	 <p>MODEL No. VBD-MTR-7C</p>	 <p>MODEL No. VBD-MTR-7W</p>
 <p>MODEL No. VBD-MTR-14C</p>	 <p>MODEL No. VBD-MTR-14W</p>	 <p>MODEL No. VBD-MTR-14B</p>	 <p>MODEL No. VBD-MTR-2C</p>
 <p>MODEL No. VBD-MTR-2W</p>	 <p>MODEL No. VBD-MTR-8C</p>	 <p>MODEL No. VBD-MTR-8W</p>	 <p>MODEL No. VBD-MTR-8B</p>
 <p>MODEL No. VBD-MTR-5C</p>	 <p>MODEL No. VBD-MTR-5W</p>	 <p>MODEL No. VBD-MTR-6C</p>	 <p>MODEL No. VBD-MTR-6W</p>

AVAILABLE TRIM MODELS



MODEL No. VBD-MTR-3C



MODEL No. VBD-MTR-3W



MODEL No. VBD-MTR-4C



MODEL No. VBD-MTR-4W



MODEL No. VBD-MTR-16C



MODEL No. VBD-MTR-16W



MODEL No. VBD-MTR-10W



MODEL No. VBD-MTR-10B



MODEL No. VBD-MTR-54T



MODEL No. VBD-MTR-59T



MODEL No. VBD-MTR-60T



MODEL No. VBD-MTR-65T



MODEL No. VBD-MTR-67T



MODEL No. VBD-MTR-70T



MODEL No. VBD-MTR-75T



MODEL No. VBD-MTR-76T



MODEL No. VBD-MTR-73T



MODEL No. VBD-MTR-74T



MODEL No. VBD-MTR-77T



MODEL No. VBD-MTR-78T



MODEL No. VBD-MTR-17-1W



MODEL No. VBD-MTR-17C



MODEL No. VBD-MTR-79W



MODEL No. VBD-MTR-80W



MODEL No. VBD-MTR-81W



MODEL No. VBD-MTR-82W



MODEL No. VBD-MTR-83W



MODEL No. VBD-MTR-84W

AVAILABLE TRIM MODELS



MODEL No. VBD-MTR-85W



MODEL No. VBD-MTR-86B



MODEL No. VBD-MTR-87W



MODEL No. VBD-MTR-88W

COLOUR TEMPERATURE	DIFFUSER	SKU NUMBER
2400K (Sunset White)	Frosted Glass (FG) Clear Lens (L)	666561428518 666561428464
2700K (Soft White)	Frosted Glass (FG) Clear Lens (L)	666561428525 666561428471
3000K (Warm White)	Frosted Glass (FG) Clear Lens (L)	666561428532 666561428488
3500K (Mid-Warm White)	Frosted Glass (FG) Clear Lens (L)	666561428549 666561428495
4000K (Natural White)	Frosted Glass (FG) Clear Lens (L)	666561428556 666561428501
5000K (Daylight)	Frosted Glass (FG) Clear Lens (L)	666561429997 666561429980
RGBW	Frosted Glass (FG)	666561428457

NOTES:

Disclaimer:

The data and information contained in this specification sheet are subject to change without notice; the ratings supplied are provided based on the product manufacturer. The information contained in this specification sheet should not be considered a warranty, expressed or implied, including, but not limited to, a warranty of merchantability or fitness for a particular purpose. In no event shall Veroboard be liable for any incidental or consequential damages resulting from the use, misuse, or inability to use the product. This exclusion applies regardless of whether such damages are sought based on breach of warranty, breach of contract, negligence, strict liability in tort, or any other legal theory.