



www.winemate.com

Wine Cooling System

Installation, Use & Care Manual

**WM-1500CD WM-
1500CTEDWM-2500CD
WM-2500CTED**



By *Vinotemp*

www.vinotemp.com

Read and save these instructions

Important Safety Information

- DO NOT PLUG IN UNTIL 24 HOURS AFTER DELIVERY.
- DO NOT USE A GROUND FAULT INTERRUPTER (GFI).
- A DEDICATED 20 AMP CIRCUIT IS REQUIRED.

WARNING



To avoid the risk of electrical shock, property damage, personal injury, or death:

- The power cord must be plugged into a 3-prong grounding type wall receptacle, grounded in accordance with the National Electrical Code, ANSI/NFPA 70 – latest edition and local codes and ordinances.
- It is the personal responsibility of the consumer to have a proper 3-prong wall receptacle installed by a qualified electrician.
- DO NOT, UNDER ANY CIRCUMSTANCES, REMOVE THE POWER CORD GROUNDING PRONG.
- A separate adequately fused and grounded circuit should be available for this appliance.
- Do not remove any grounding wires from individual components while servicing unless the component is to be removed and replaced. It is extremely important to replace all grounding wires when components are replaced.

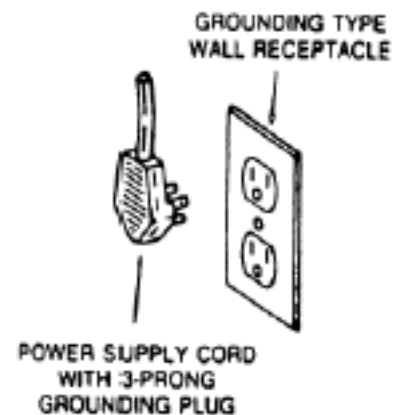

WARNING



ELECTRICAL SHOCK HAZARD

- Disconnect electrical supply from appliance before servicing.
 - Replace all panels before operating.
- Failure to do so could result in death or electrical shock.

Table of Contents

Features & Specifications.....	3
Installation Instructions.....	5
Temperature and Humidity.....	10
Care Guide.....	14
Troubleshooting.....	15
Wiring Diagram.....	18
Customer Support.....	20
Warranty.....	21

Features and Specifications

- WM-1500CD, CTED and WM-2500CD, CTED cooling units are designed and used to provide a subtle temperature between 50~65 °F for a properly insulated wine cabinet.
- The refrigerated space will maintain humidity range within 50~70% RH.
- These temperature and humidity ranges are optimized for long term storage of wine.
- Temperature is controlled and humidity is adjusted using innovative technology.
- Bottom cold-air supply is optimized for use in the wine cabinets.
- Multiple options for top and rear hot air exhaust are convenient for installations.
- The unit is self-contained ready for easy installation and use.

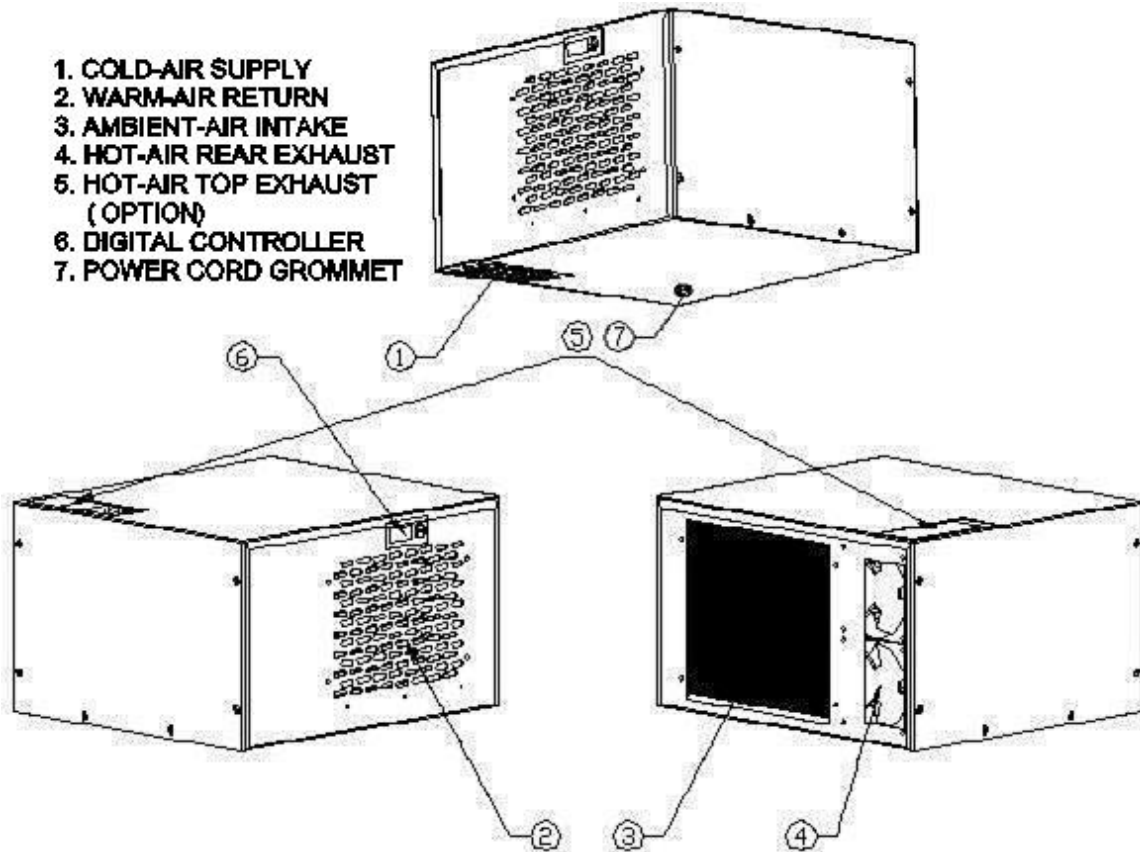

Fig. 1.1 FEATURE DESCRIPTIONS

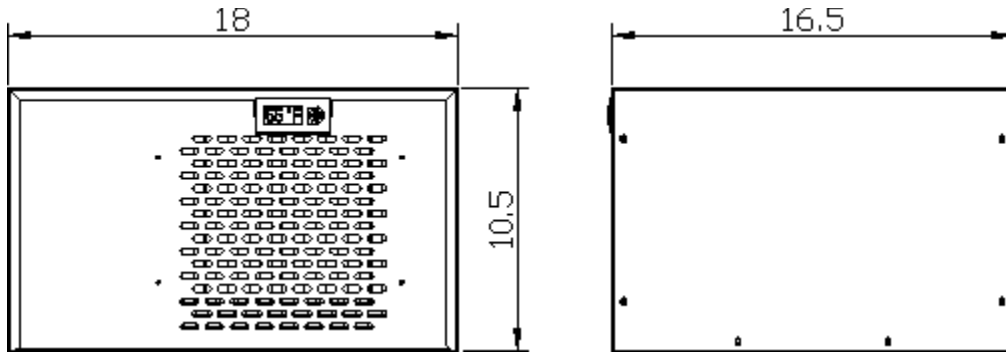

Fig. 1.2 DIMENSIONS (in)

The specifications and dimensions are listed as follows:

Model	Exhaust	CF M	Cabinet Size (cu ft)	Electrical	Weight(lb)
WM-1500cd	Rear Exhaust	120	90	115V/60Hz/4A	50
WM-1500ctcd	Top Exhaust	120	90	115V/60Hz/4A	50
WM-2500cd	Rear Exhaust	180	200	115V/60Hz/5A	55
WM-2500ctcd	Top Exhaust	180	200	115V/60Hz/5A	55

NOTES:

- Also see the voltage, frequency and current specified on the label at the cooling unit.
- The rated capacity is determined under the cabinet and ambient temperatures of 55°F and 75°F with R13 interior and R19 exterior insulations. Any lower cabinet temperature, higher ambient temperature and less insulation will cause reducing capacity and may not maintain 55°F.
- The ambient temperatures for WM-1500CD shall not be higher than 78°F or lower than 50°F in order to operate properly.
- The ambient temperatures for WM-2500CD shall not be higher than 95°F or lower than 50°F in order to operate properly.

Installation Instructions

NOTES:

- Mounting brackets, screws, gaskets and other seal materials are not included.
- Do not install any ducts onto the supply, return, intake and exhaust.
- There is a grommet on the power cord and it must be installed properly, otherwise hot air may enter into the cabinet.
- We strongly recommend against the use of an extension cord. However, if you still select to use an extension cord, it is absolutely necessary that it is a UL LISTED 3-wire grounding type appliance extension cord. The marked rating of the extension cord shall be 115 V, 15 A. or equivalent and not greater than 15ft in length.

1. Cabinet Location

- Place the wine cabinet in a properly ventilated location. Otherwise, heat exhausted by the cooling unit will build up and it will not operate properly.
- The exhaust area must not be a closed space and must be ventilated.
- The ambient temperatures shall not be higher than 78°F for a WM-1500CD unit and 95°F for a WM-2500CD unit or lower than 50 °F.

1) Rear Exhaust Location

- Leave min 6" clearance from the rear to the wall.
- Leave min 12" clearance from the top to the ceiling.
- Leave min 6" clearance from the left and right sides.

2) Front Exhaust Location

- Leave min 6" clearance from the front if left and right sides unobstructed.
- Or, leave min 36" clearance from the front if left and right sides obstructed.

3) Top Exhaust Location

- Leave min 12" from the top to the ceiling.
- Leave min 2" clearance from the rear to the wall.
- Leave min 2" clearance from the left and right sides.

4) Side Exhaust Location

- Leave min 6" clearance from the left or right side to the wall.
- Leave min 12" clearance from the top to the ceiling.

2. Cooling Unit Installation

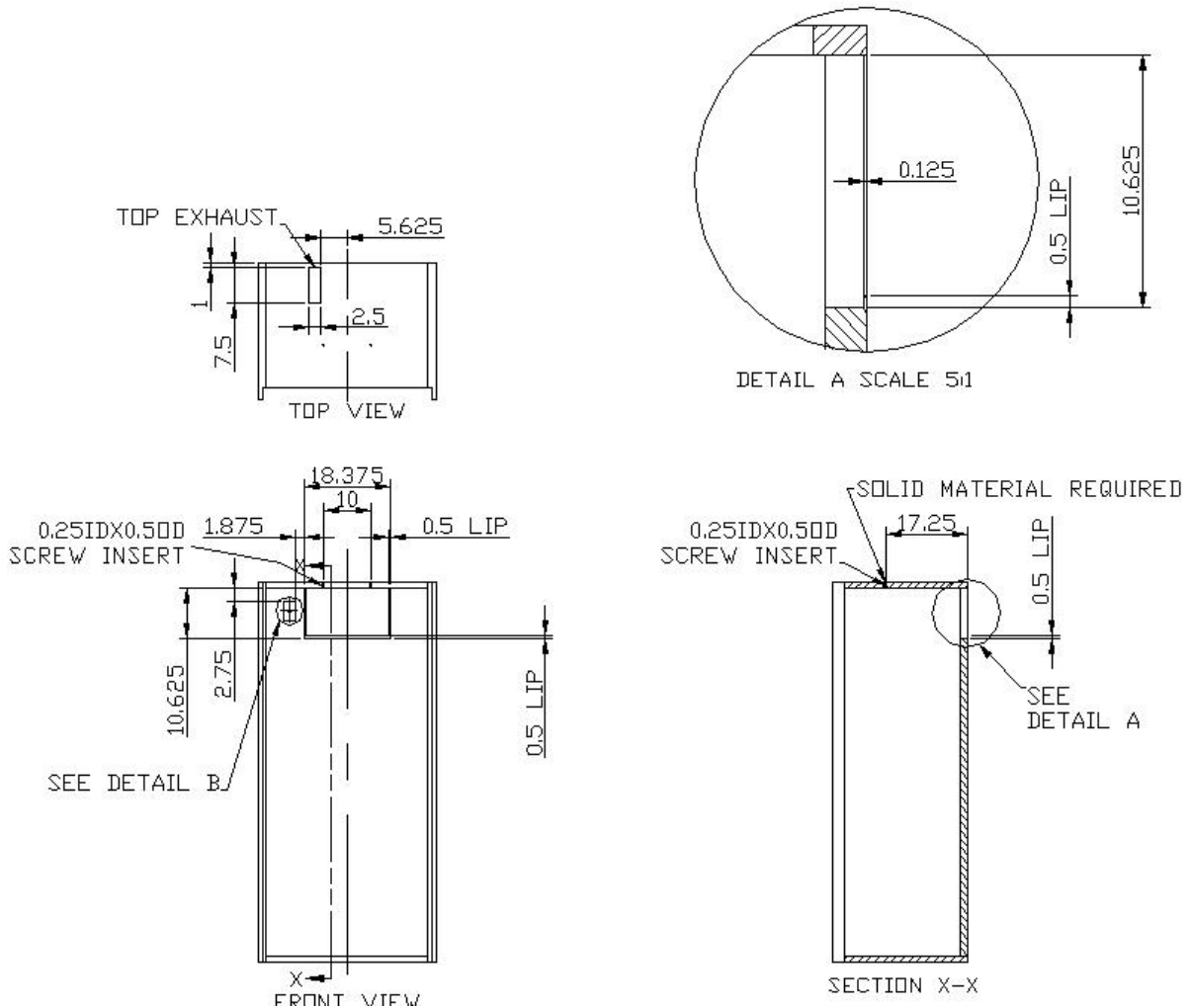

Fig. 2.1 CUTOUT AND HOLE DIMENSIONS

- The cooling unit produces cooling supplied into the cabinet, meanwhile it also generates heat that must be exhausted outside the cabinet. So the cold-air supply with return-air intake and hot-air exhaust with ambient-air side must be separated and sealed. Foam tape gasket may be used to seal them. The cooling unit must intake adequate fresh ambient-air to work properly. The ambient-air intake and hot-air exhaust must not be short-circulated. A piece of wood may be used to separate them.
- Cut a rectangular inside opening at the rear of the cabinet with the 1/4" clearance inwards to the width and height of the cooling unit. By not going through, leave 1/2" lip inside at the wall to place the gaskets (see Fig. 2.1 & 2.2).
- If top exhaust installation, cut another rectangular opening at the top of the cabinet to the length and width of the top exhaust (see Fig. 2.1 & 2.3).

- Place the gaskets (1/2" foam tape) on the gasket lips (see Fig. 2.5).
- If top exhaust, place another gaskets along the top exhaust at the top of the cooling unit (see Fig. 2.6).
- Move the cooling unit towards the mounting sides and push to press the gaskets.
- Use 2 mounting brackets and 1/4" screws with 7/16" wrench to secure the cooling unit (see Fig. 2.7).
- Attach the exhaust wall grille with screws from the rear side of the cabinet (see Fig. 2.8).
- Press and fit the grommet into the hole at the bottom of the cooling unit to prevent the exhaust air from going into the cabinet (see Fig. 1.1).
- Plug the cooling unit in the cabinet receptacle.
- Plug the wine cabinet.



Fig. 2.2 REAR EXHAUST CUTOUT



Fig. 2.3 TOP EXHAUST CUTOUTS

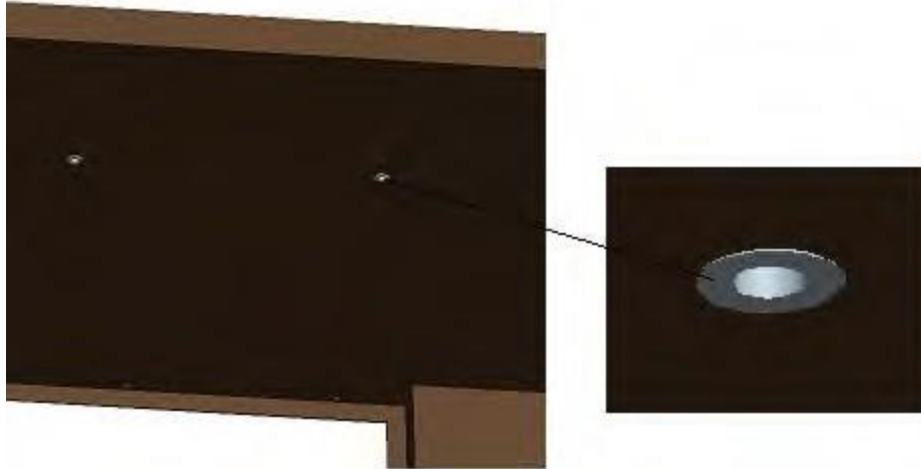

Fig. 2.4 MOUNTING SCREW INSERTS



Fig. 2.5 REAR EXHAUST GASKETS

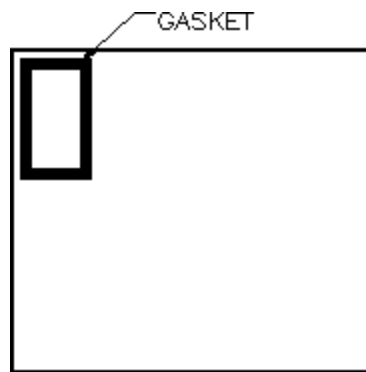

Fig. 2.6 TOP EXHAUST GASKET

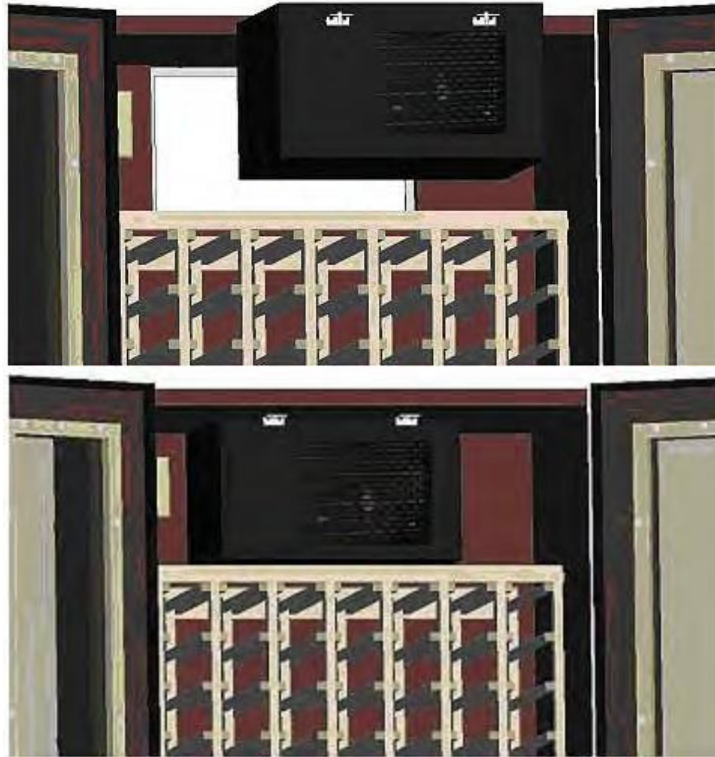

Fig. 2.7 MOUNTING COOLING UNIT

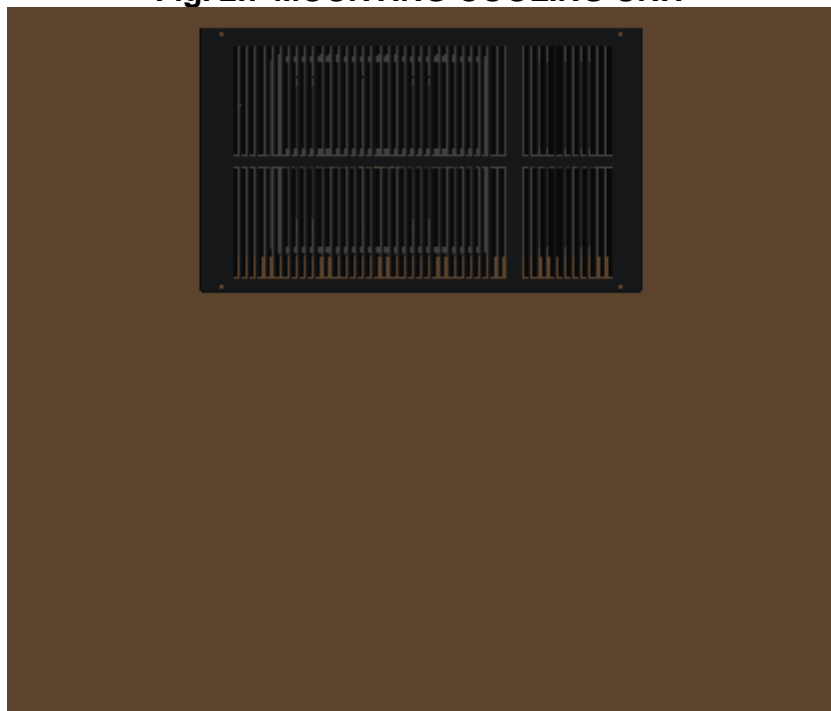

Fig. 2.8 INSTALLING WALL GRILLE

Temperature and Humidity

1. The controller



Fig. 3.1 TEMPERATURE CONTROLLER

1) Keys

SET: To display set-point; in programming mode it selects a parameter or confirms an operation.

: To start a manual defrost.

: To see the maximum stored temperature; in programming mode it browses the parameter codes or increases the displayed value.

: To see the minimum stored temperature; in programming mode it browses the parameter codes or decreases the displayed value.

: To turn on/off the power to the unit.

+: To lock/unlock the keypad.

SET+ : To enter in the programming mode.

SET+ : To return to the temperature display.

2) Lock and unlock the keys

To lock the keys, press up + down keys + until POF is displayed; to unlock the keys, press up + down keys + until PON is displayed.

3) Display

During normal operating conditions, the display shows the value measured by the air temperature probe. In case of active alarm, the temperature flashes alternately to the code alarm. The LED functions are listed as follows.

LED	MODE	FUNCTION
	ON	Compressor enabled
	Flashing	Anti-short cycle enabled
	ON	Defrost cycle enabled
	ON	Fan enabled
	Flashing	Fan delay after defrost enabled

	ON	Alarm occurring
°C/°F	ON	Temperature measuring unit
°C/°F	Flashing	Programming mode

4) Alarm Signals

The alarm codes are described as follows.

MESSAGE	CAUSE	FUNCTION
P1	Temperature probe faulty	Compressor switching to Con and CoF
HA	High temperature alarm	Probe temperature ALU higher than the setting temperature; Outputs unchanged
LA	Low temperature alarm	Probe temperature ALL lower than the setting temperature; Outputs unchanged
CA	External alarm	All outputs off

Probe alarms P1”, start a few seconds after the fault in the related probe; they automatically stop a few seconds after the probe restarts normal operation. Check connections before replacing the probe. Temperature alarms “HA”, “LA” automatically stops as soon as the temperature returns to normal value. Alarm “CA” (with i1F=PAL) recovers only by switching off and on the instrument.



2. Temperature Setting

- Set the temperature at 55 °F for the optimum aging of wine
- On initial start-up, the time required to reach the desired temperature will vary, depending on the quantity of bottles, temperature setting and surrounding temperature.
- Allow 24 hours to stabilize the temperature for each new temperature setting operation

3. How to see temperature set-point

- 1) Press and immediately release the **SET** key, the display will show the set-point value.
- 2) Press again and immediately release the **SET** key to display the probe value.

4. How to change the set-point







- 1) Press and hold the **SET** key until the “°C” or “°F” LED starts flashing and the set-point is displayed.
- 2) Press the up/down keys / to change the set-point value within 10 sec.
- 3) Press the **SET** key again to store the new set-point value.

NOTE: The unit turns on at set-point **Set** plus regulation differential **H_y** after anti-short cycle **AC** has elapsed; the unit turns off at set-point **Set**.

5. Manual Defrost

Press and hold the defrost  key until defrost starts. The defrost indicator will be on.

6. Parameter Programming

- 1) Press and hold the **SET** +  keys until the “°C” or “°F” LED starts flashing, then release the keys.
- 2) Press and hold again the **SET** +  keys until the **Pr2** label is displayed, then release the keys. The first parameter **Hy** will be displayed.
- 3) Press up/down keys / to scroll to the required parameter within 10 sec.
- 4) Press the “**SET**” key to display its value.
- 5) Use up/down keys / to change its value within 10 sec.
- 6) Press “**SET**” to store the new value and the display will flash 3 times.
- 7) **To exit:** Press **SET** +  or wait 15sec without pressing a key.

PARAMETER	DESCRIPTION	DEFAULT VALUE
Set	set-point (°)	55
Hy	temperature regulation differential (°)	4
AC	anti-short cycle delay (min)	10
Con	compress on with probe faulty (min)	15
CoF	compress off with probe faulty (min)	30
CF	temperature unit (°F/ °C)	F: Fahrenheit
rES	display resolution	in: integer
dLy	temperature display delay (min)	1
ot	probe calibration (°)	0
LS	minimum set-point (°)	50
US	maximum set-point (°)	65
idF	defrost cycle interval time (hour)	12
MdF	defrost cycle endurance time (min)	30
ALC	temperature alarm type	rE: relative to set-point
ALU	high temperature alarm (°)	10
ALL	low temperature alarm (°)	10
AFH	alarm recovery differential (°)	5
ALd	temperature alarm delay (min)	60
dAO	temperature alarm delay on startup (hr)	23
SAA	heater set-point (°)	40
SHy	heater regulation differential (°)	4
FSU	fan action	Std
FnC	fan operating mode	C-n: on with compressor & off during defrost
Fon	fan on with compressor off (min)	0
FoF	fan off with compressor off (min)	15

NOTE: Depending on the controller, not all parameters are used.

7. How to calibrate the air probe

If the actual cellar temperature differs from the setting temperature, set

parameter **ot** = actual cellar temperature minus set-point.

8. How to adjust the defrost cycle

In case there is excessive frost, the parameters **FnC** = C-y, **idF** = 4 and **MdF** = 20 can be used to avoid frost.

9. How to adjust the humidity

The parameter **Fon** is used to adjust the humidity in the wine cellar. Higher **Fon** results in higher relative humidity. Use a separate hygrometer to monitor the humidity.

10. How to set alarm call

1) Speech notice will be sent to your phones when the cellar temperature is **ALU** higher or **ALL** lower than the set-point **Set**.

2) In order to test the call function, set parameters **Ald** = 0 and **dAO** = 0. After testing, set **Ald** = 60 and **dAO** = 23.

11. How to set low cellar temperature heater

The heater turns on at **SAA** minus **Shy**; the heater turns off at **SAA**.

NOTES:

- Use a forced air heater to warm up the wine cellar.
- If there is a thermostat on the heater, bypass it or set the thermostat at the highest level.

If the heater runs more than 10 A current, use a 120VAC coil contactor.

Care Guide

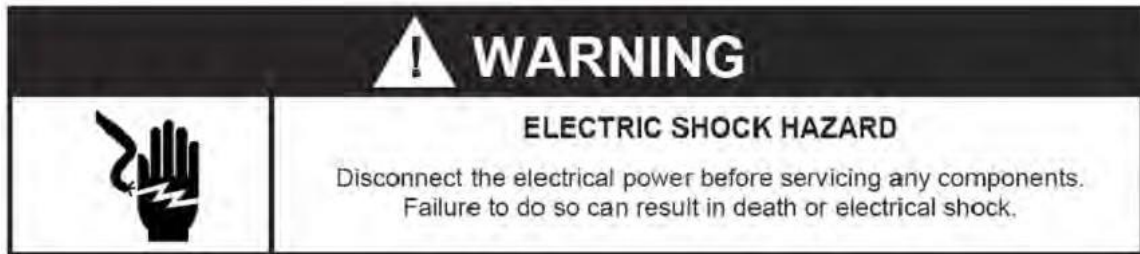

1. Cleaning Condenser

- Clean the condenser regularly at least every 6 months.
- Condenser is located on the ambient air intake side of the cooling unit.
- Use a condenser brush or a vacuum cleaner with an extended attachment to clean the condenser.

2. Removing Condensate

Remove the excessive condensate if it is accumulated on the cooling unit in high humidity conditions.

3. Removing Unit

When you remove the cooling unit, beware water may come out of the unit.

Troubleshooting

This Troubleshooting Chart is not prepared to replace the training required for a professional refrigeration service person, not is it comprehensive

Complaint	Possible Causes	Response
1. Unit not running	<ul style="list-style-type: none"> a. Power cord not plugged b. No power from supply c. Incorrect or loose wirings d. Low voltage e. Setting higher than ambient temperature f. Cut-in too high g. Defrost light blinking h. Compressor light blinking i. Defective controller 	<ul style="list-style-type: none"> a. Check power cord b. Check receptacle and fuses c. Check all wirings and connections d. Contact an authorized electrician e. Lower temperature setting f. Reduce Hy g. Unit is under defrost mode h. Unit is under anti-short cycle delay i. Call service for diagnosis
2. Unit not starting , but temperature rising high	<ul style="list-style-type: none"> a. Anti-short cycle 	<ul style="list-style-type: none"> a. Reset AC
3. Temperature fluctuating	<ul style="list-style-type: none"> a. Air probe 	<ul style="list-style-type: none"> a. When using an air probe, the wine bottle temperature is mainly controlled by the average air temperature. If the set-point is 55°F with the differential 4F, the cooling unit turns on at 59°F of air temperature (It may be higher than 59°F if it is in anti-short cycle or defrost cycle) and turns off at 55°F of air temperature. The average air temperature is 57°F, and then the wine temperature is around 57+/- 0.5°F. The air is light enough to change so quickly that it maintains relatively constant average temperature that would prevent wine bottle temperature from fluctuating.
4. Temperature high, unit stopping and starting normally	<ul style="list-style-type: none"> a. Temperature setting high 	<ul style="list-style-type: none"> a. Lower the setting
5. Temperature high, unit stopping and starting with short running time	<ul style="list-style-type: none"> a. Air probe touching the evaporator coil, displaying temperature ok b. Short circuit of air flow between cold-air supply and cellar-air return, displaying temperature ok c. Failed controller and probe 	<ul style="list-style-type: none"> a. Move the air probe away from the evaporator b. Deflect the supply air down c. Call service for diagnosis
6. Temperature	<ul style="list-style-type: none"> a. Improper cellar insulation & seal 	<ul style="list-style-type: none"> a. Check insulation, gasket and door

<p>high or not cooling and running continually</p>	<ul style="list-style-type: none"> b. Cellar too large c. Ambient temperature too high d. Exhaust restricted e. Malfunctioning fans f. Evaporator or condenser airflow g. Dirty Condenser h. Iced evaporator i. Refrigeration system restriction j. Refrigerant leak k. Undercharge or overcharge l. Failed components 	<p>opening, power cord grommet</p> <ul style="list-style-type: none"> b. Check for excessive size c. Check installation location d. Leave minimum 3 feet clearance for the hot air exhaust side and leave minimum 1 foot clearance for the fresh air intake side e. Check for both evaporator and condenser fans f. Check for air restrictions, air short-circulation, grille directions g. Clean condenser h. Defrost and reset temperature i. Call service j. Call service k. Call service l. Check compressor windings, start relay and overload protector
<p>7. Unit running too long</p>	<ul style="list-style-type: none"> a. Improper cellar insulation & seal b. Cellar too large c. Ambient temperature higher >90°F d. Exhaust restricted e. Dirty Condenser f. Improper condenser air flow 	<ul style="list-style-type: none"> a. Check insulation, gasket and door opening, power cord grommet b. Check for excessive size c. Check for installation location d. Leave minimum 3 feet clearance for the hot air exhaust side and leave minimum 1 foot clearance for the fresh air intake side e. Clean condenser f. Check for fan and air short circulation
<p>8. Fan motor running but compressor not running</p>	<ul style="list-style-type: none"> a. Post-compressor fan running mode b. Incorrect or loose wirings c. Failed components d. Liquid refrigerant in the compressor 	<ul style="list-style-type: none"> a. Check fan running time FON b. Check all wirings and connections c. Check start relay, start capacitor, overload protector, compressor. d. Call service.
<p>9. Compressor running but fan not running</p>	<ul style="list-style-type: none"> a. Fan blade stuck b. Incorrect or loose wirings c. Failed motors 	<ul style="list-style-type: none"> a. Check for proper clearance b. Check all wirings c. Call service
<p>10. Temperature high, compressor stopping and starting but very short running time</p>	<ul style="list-style-type: none"> a. Failed components b. Improper condenser airflow c. Dirty condenser d. Overcharge of refrigerant e. Discharge or suction pressure too high 	<ul style="list-style-type: none"> a. Check compressor windings, start relay and overload protector. b. Check for condenser fan c. Clean condenser d. Call service for removing refrigerant e. Call service for information

11.Fan running too long	a. Post-compressor fan running mode for humidity modulation	a. Reset FON
12.Temperature	a. Low temperature setting	a. Raise the setting

low	<ul style="list-style-type: none"> b. Low ambient temperature c. Air probe fault d. Temperature controller fault 	<ul style="list-style-type: none"> b. Move to another location c. Change a new one d. Change a new one
13. Evaporator freezing up	<ul style="list-style-type: none"> a. Evaporator air flow restriction b. Low temperature setting c. Low ambient temperature d. Defective controller or probe e. Not stopping due to air leak, high ambient temperature, condenser air flow restriction or pull-down cooling f. Initially working then stopping, moisture in the system g. Refrigerant low or leaking h. Capillary tube or expansion valve blockage 	<ul style="list-style-type: none"> a. Check for fans and air flow b. Check for set-point c. Change defrost cycle d. Check for controller and probe e. Check for seal, door opening, ambient temperature and condenser air flow f. Call service g. Call service h. Call service
14. Water leak	<ul style="list-style-type: none"> a. Air leak in the wine cellar causing excessive condensate b. High humidity causing excessive condensate c. Evaporator air flow restriction d. Water passages restricted, water overflowing e. Drip tray leak 	<ul style="list-style-type: none"> a. Check for air leak b. Use drain line c. Check supply air flow or air TD d. Clean the drip tray e. Seal the leak using silicone sealant
15. Excessive condensate in wine cellar	<ul style="list-style-type: none"> a. Air leak in the wine cellar causing excessive condensate b. High humidity causing excessive condensate c. Water passages restricted 	<ul style="list-style-type: none"> a. Check for any air leak b. Use drain line c. Clean the drip tray
16. Circuit tripping	<ul style="list-style-type: none"> a. Incorrect fuse or breaker b. Incorrect wirings c. Failed components 	<ul style="list-style-type: none"> a. Check for proper fuse or breaker b. Check for wirings and connections c. Call service
17. Noisy operation	<ul style="list-style-type: none"> a. Mounting area not firm b. Loose parts c. Compressor overloaded due to high ambient temperatures or airflow restriction d. Defective components 	<ul style="list-style-type: none"> a. Add support to improve installation b. Check fan blades, bearings, washers, tubing contact and loose screws. c. Check for airflow d. Call service for checking internal loose, inadequate lubrication and incorrect wirings

Wiring Diagram

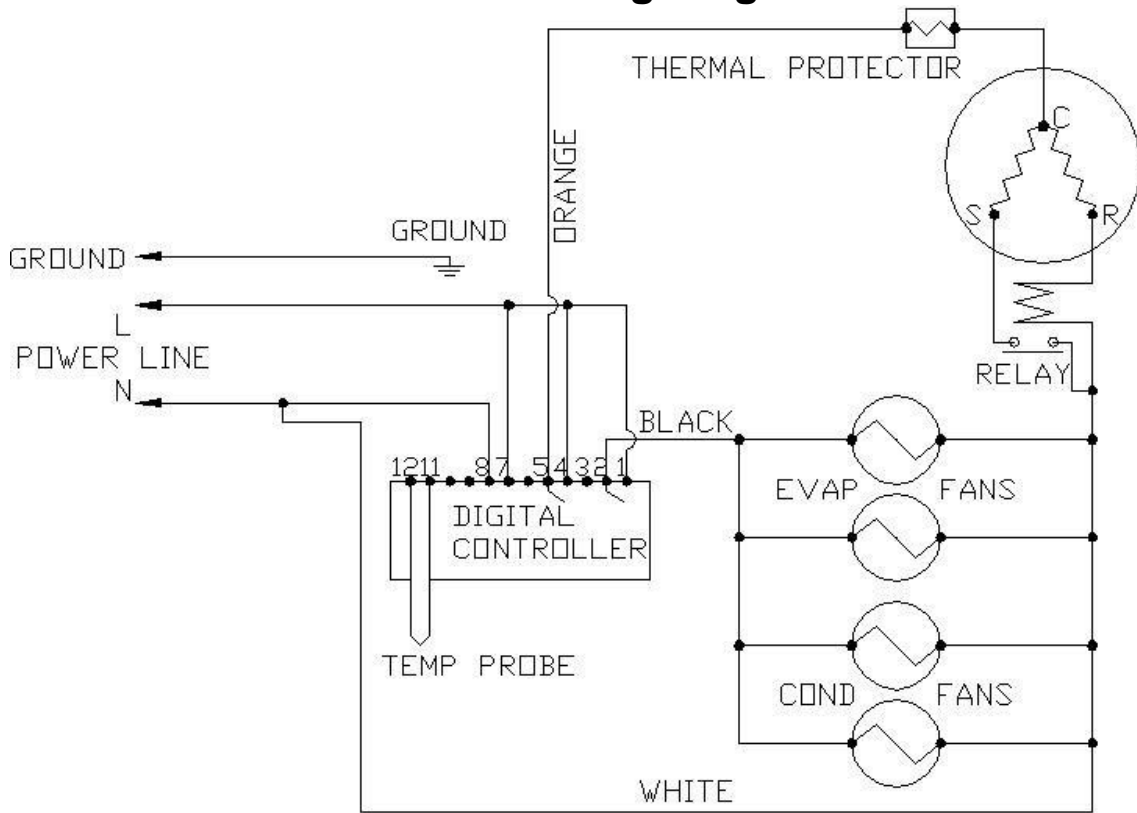

Fig. 6.1 WIRING DIAGRAM

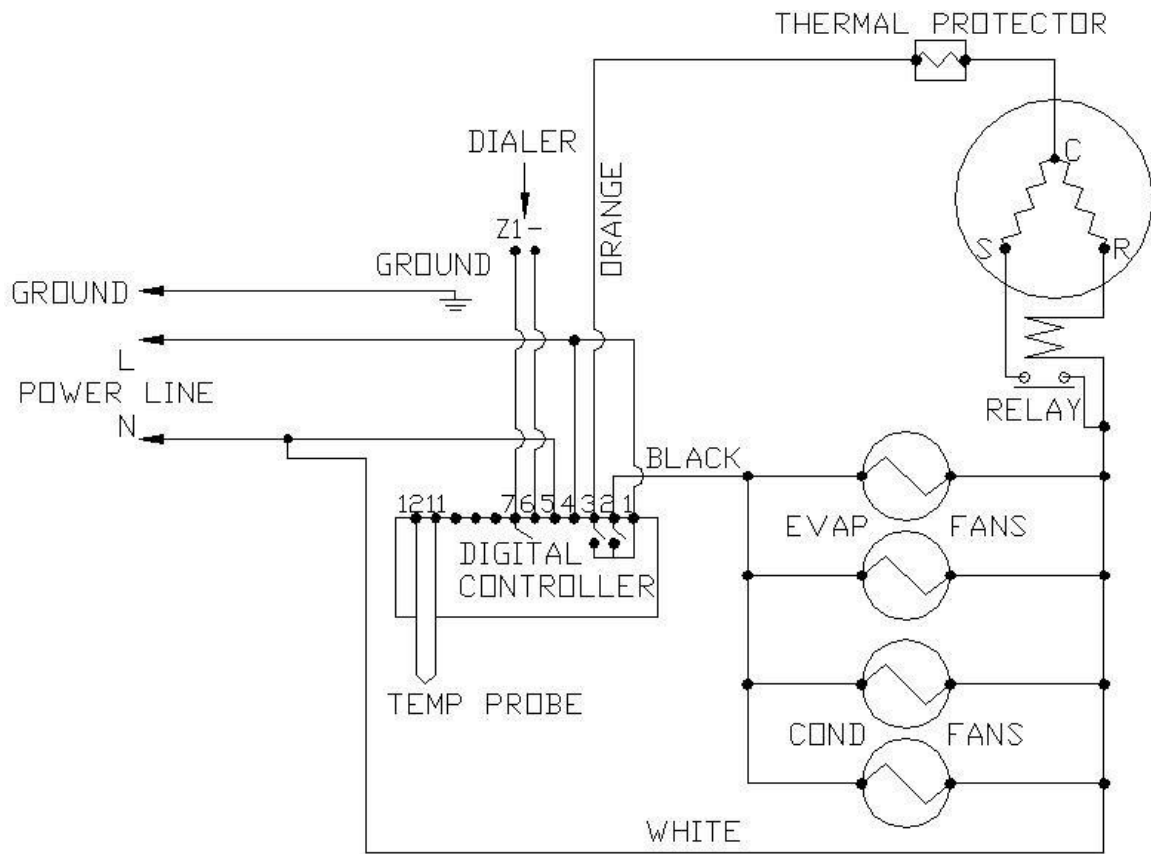

Fig. 6.2 WIRING DIAGRAM (ALARM CALL)

Customer Support

If you need further assistance, please contact us at:

Vinotemp International
732 South Racetrack Road
Henderson, NV 89015
Tel: (800) 777-8466
Fax: (310) 886-3310
Email: info@vinotemp.com

Warranty

Thank you for choosing a Vinotemp cooling unit.

Please enter the complete model and serial numbers in the space provided:

Model _____

Serial No. _____

Attach your purchase receipt to this owner's manual.

1. Limited Warranty

VINOTEMP warrants its products, parts only, to be free from defects due to workmanship or materials under normal use and service for twelve months after the initial sale. If the product is defective due to workmanship or materials, is removed within twelve months of the initial sale and is returned to VINOTEMP, in the original shipping carton, shipping prepaid, VINOTEMP will at its option, repair or replace the product free of charge.

This warranty constitutes the entire warranty of the VINOTEMP with respect to its products and is in lieu of all other warranties, express or implied, including any of fitness for a particular purpose. In no event shall VINOTEMP be responsible for any consequential damages what is so ever. Any modification of VINOTEMP products shall void this warranty.

Service under Warranty

This service is provided to customers within the continental UNITED STATES only. VINOTEMP cooling units are warranted to produce the stated number of BTU/H. While every effort has been made to provide accurate guidelines, VINOTEMP can not warranty its units to cool a particular enclosure.

In case of failure, VINOTEMP cooling units must be repaired by the factory or its authorized agent. Repairs or modifications made by anyone else will void the warranty.

Shall a VINOTEMP cooling unit fail, contact the dealer for instructions, do not return the unit to the factory without authorization from VINOTEMP. If the unit requires repair, re-pack it in the original shipping carton and return it to the factory, shipping prepaid. VINOTEMP will not accept COD shipments. If the unit

is determined to be faulty and is within the twelve month warranty period VINOTEMP will, at its discretion, repair or replace the unit and return it free of charge to the original retail customer. If the unit is found to be in good working order, or beyond the initial twelve month period, it will be returned freight collect.

2. Limitation of Implied Warranty

VINOTEMP'S SOLE LIABILITY FOR ANY DEFECTIVE PRODUCT IS LIMITED TO, AT OUR OPTION, REPAIRING OR REPLACING OF UNIT.

**VINOTEMP SHALL NOT BE LIABLE FOR:
DAMAGE TO OTHER PROPERTY CAUSED BY ANY DEFECTS IN THE UNIT,
DAMAGES BASED UPON INCONVENIENCE, LOSS OF USE OF THE UNIT,
LOSS OF TIME OR COMMERCIAL LOSS, ANY OUTER DAMAGES,
WHETHER INCIDENTAL, CONSEQUENTIAL OR OTHERWISE.**

THIS WARRANTY IS EXCLUSIVE AND IS IN LIEU OF ALL OTHER WARRANTIES, EXPRESSED OR IMPLIED, INCLUDING BUT NOT LIMITED TO, IMPLIED WARRANTIES OF MERCHANTABILITY OR FITNESS FOR A PARTICULAR PURPOSE.

While great effort has been made to provide accurate guidelines VINOTEMP cannot warrant its units to properly cool a particular enclosure. Customers are cautioned that enclosure construction, unit location and many other factors can affect the operation and performance of the unit. There for suitability of the unit for a specific enclosure or application must be determined by the customer and cannot be warranted by VINOTEMP.

Protect Your Investment with an Extended Warranty!



Add a New Leaf extended warranty to your order, and have the security of knowing that if there should be a problem, even years in the future, New Leaf will be there to assist! Usable for any Wine Cellar or other electronic device manufactured by Vinotemp. Add this warranty to purchases made from vinotemp.com or other qualified vendors. Warranty must be registered within the first 10 days from original purchase.

Visit www.vinotemp.com to purchase.