

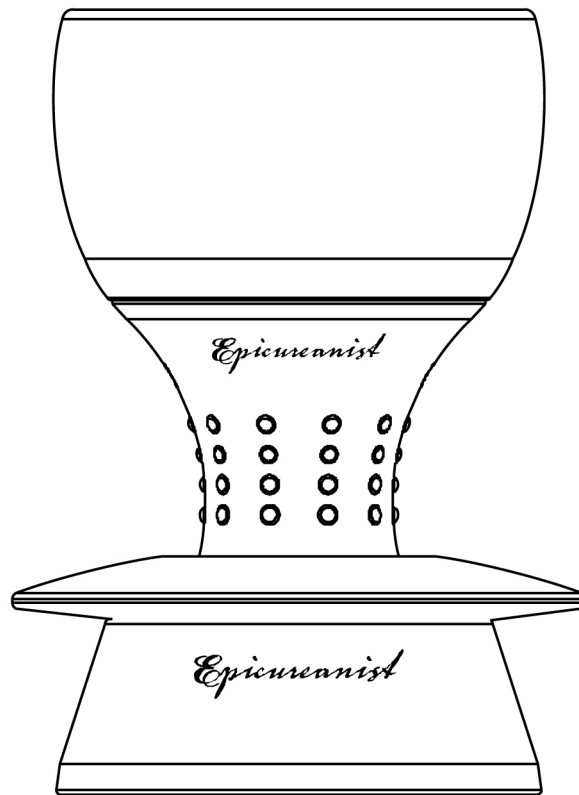

# Trilux Wine Aerator



EP-AERATOR001

**OWNER'S MANUAL**

# **EPICUREANIST TRILUX WINE AERATOR**

Thank you for purchasing an EPICUREANIST product. Please read all the instructions before attempting to operate this product and save this instruction manual for future reference.

## **WHY DOES WINE NEED TO BREATHE?**

Every wine has certain aromas associated with it and if the wine does not breathe, then one cannot taste all the aromas. Wines that need aging and haven't reached full maturity may not have the aromas and flavor that is expected when first opened. Exposing wine to air will provide a gentle oxidation that compares to aging wine in a cellar.

A young wine needs to breathe less air to mellow its harsh taste and improve its texture. Older wines, on the other hand, need to breathe more air to enhance their flavor and smooth their finish. How much air the wine needs to breathe, ultimately, depends on your own taste.

## **PRODUCT FEATURES**

The EPICUREANIST Trilux wine aerator speeds up the process of breathing by instantly aerating with ease and convenience.

When wine is poured through the aerator, its internal delicate design creates different pressure to mix the air with wine for perfect aeration—shortening the wine breathing time to seconds.

The unique feature of this aerator is that the aeration level is adjustable: high aeration - medium aeration - low aeration. There are three different size holes in the built-in aeration plate. When adjusted to the small holes, the wine flows slowly and the wine breathes more. When adjusted to the big holes, the wine flows rapidly and the wine breathes less air. When set to the mid-sized holes, the wine breathes a medium quantity of air.

# STRUCTURE

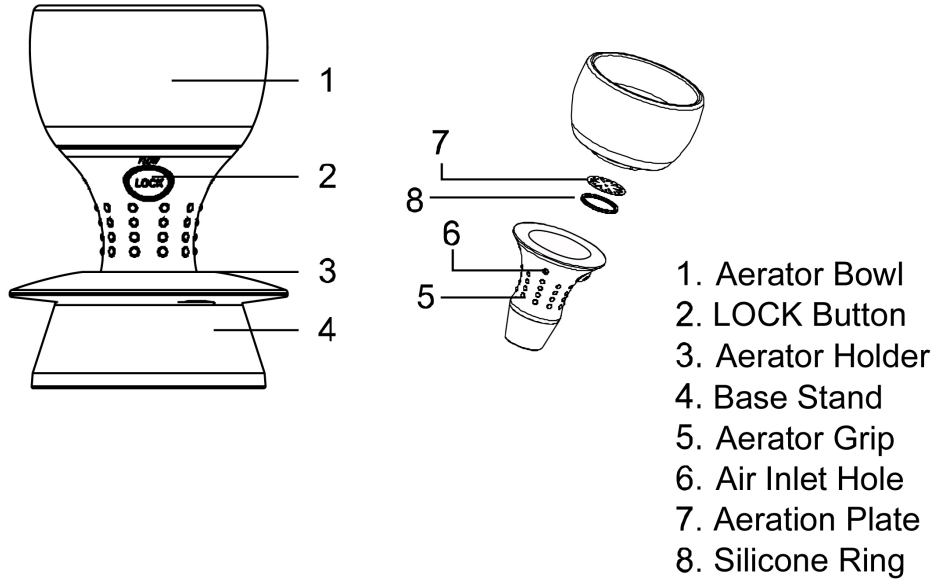

# OPERATION INSTRUCTIONS

Rinse the wine aerator, aerator holder and aerator base before each use.

## CHOOSE THE PROPER AERATION LEVEL

1. Look into the cup and line up the holes at the bottom of the cup with the amount of aeration desired.
2. To change aeration level, hold aerator grip with one hand and rotate the aerator bowl with the other.

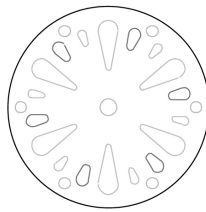

Aeration Plate

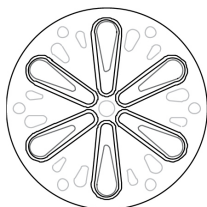

Big Holes:  
Low Aeration

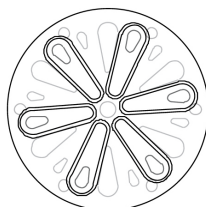

Middle Holes:  
Middle Aeration

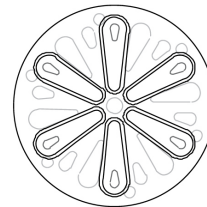

Small Holes:  
High Aeration

## POURING WINE

3. Place the aerator over the top of the wine glass with the flat side resting on the glass rim and the center protruding into the glass. (Fig. 3)
4. Hold the wine aerator upright and place in the middle of the aerator holder. (Fig. 4)
5. Slowly pour the wine into the bowl of the wine aerator. (Fig. 5)  
Note: You may hear noise as the wine aerator draws air in and mixes the proper amount of air and wine as it then flows into the wine glass.
6. Place the wine aerator on its base after each use. (Fig. 6)

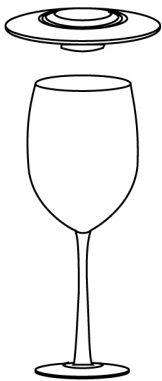

Fig. 3

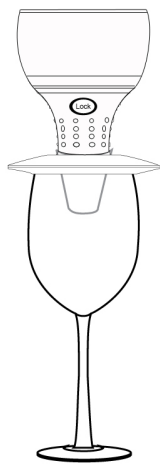

Fig. 4

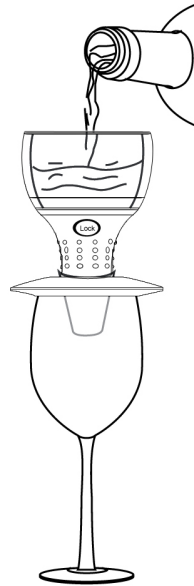

Fig. 5

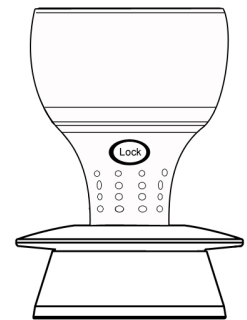

Fig. 6

You can adjust the aeration level constantly to get the wine's best flavor, bouquet and taste.

## WARNING

- Do not block the air inlet hole during use.
- The wine aerator is only suitable for use with red or white wine. Do not use with any other liquid and do not use as a funnel.
- Wash the wine aerator after each use to prevent wine from being retained in the metal filter plate and unit.
- BE CAREFUL.. Don't press the LOCK button during use.

## CLEANING INSTRUCTIONS

Always rinse the wine aerator, aerator holder and base with water after each use. Dry the wine aerator before storage.

This adjustable aerator can be taken apart in two parts, the aerator bowl and the aerator grip. Press the LOCK button, rotate the bowl, and separate the two parts. The bowl and the grip can be cleaned thoroughly. (Fig. 7)

**Warning:** Hand wash only with water and mild soap. Do not use abrasive and corrosive cleaner to clean the unit, which will damage the unit.

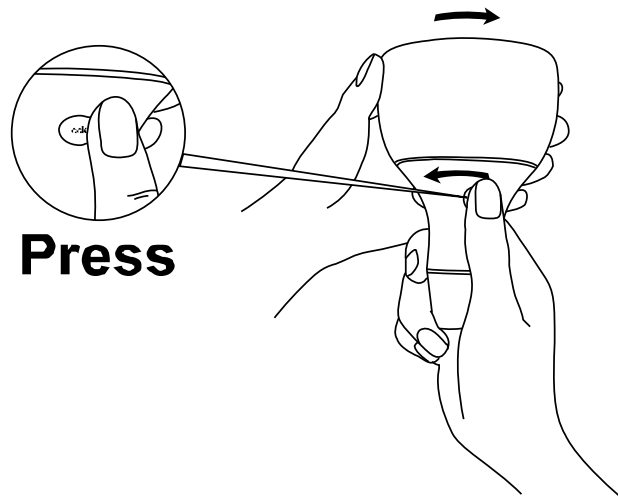

Fig.7

# TERMS OF SALE & WARRANTY

Epicureanist ("Seller") and the person or entity that acquires these goods from Seller ("Purchaser") hereby fully agree to the following terms and conditions of the sale: Shipping fees are the responsibility of the Purchaser whether freight prepaid or freight collect. Seller assumes no responsibility for the goods sold to the Purchaser once the goods have left the Seller's premises, including, but not limited to, late delivery by the moving carrier, or for events caused by any difficulty carrier incurs in attempting to fit the goods into the Purchaser's place of business or residence due to the size of the goods or otherwise. Purchaser assumes all responsibility for delivery, payment of freight, access, measurement, installation, hook-up, wiring, moving and storage of the goods.

The transportation of all goods is subject to the terms and conditions which the moving carrier imposes on Purchaser including, but not limited to, additional charges imposed per flight of stairs, and/or additional charges resulting from the carrier's inability to safely and/or adequately use the building elevator to lift the goods to an upper floor. Any claim for damages incurred during shipment by the carrier of the goods are insured and handled directly with the carrier. Any damages due to manufacture defects will be handled directly with Epicureanist, subject to the limited warranty.

All sales are final, and unless authorized in writing by the Seller, Purchaser may not return the goods, under any circumstance. If Purchaser refuses to accept the goods, under any circumstance, the Purchaser is liable for the return and cost of freight both ways, and if Seller does take back the goods, there will be a restocking charge that is 35% of the purchase price of the goods. Racking is nonrefundable. Purchaser must notify Seller of non-conforming goods within four days of delivery, after which time all goods are deemed accepted. If an order has been placed and production has started, cancellation of your order will be a 15% charge.

If Purchaser tenders payment with a check that has insufficient funds (NSF), or stops payment on a check or credit card for any reason, Purchaser agrees to pay for all costs associated with the Seller's connection or litigation of such a claim, including without limitation extra damages, court costs and attorneys' fees. Finance charges begin the date of invoice. Collection fees plus NSF fee of \$50 will be added to your invoice, which you agree to promptly pay. Title to the goods does not pass until payment is received in full by Seller and Seller retains a security interest in the goods until they are paid for in full.

Epicureanist does not warrant wine accessories. Purchaser understands and acknowledges that the goods sold here are wine storage products and accessories. Purchaser assumes all risk of using these units, including risk of spoilage, humidity variations, temperature variations, leaks, fire, water damage, mold, mildew, dryness and similar and any other perils that might occur. Seller is not responsible for incidental or consequential damages, and there are no warranties, expressed or implied, which extend beyond the Limited Warranty described above. The implied warranties of merchantability and of fitness for a particular purpose are hereby expressly disclaimed. Some states do not allow the exclusion of incidental or consequential damages, or a waiver of the implied warranties of fitness and/or merchantability, so the above limitations may not apply to you. This warranty gives you specific legal rights and you may also have other rights which vary from state to state.

In the event of any dispute between Seller and Purchaser arising out of or relating to these terms and conditions or to the goods sold generally, Purchaser must first file a written claim with Seller within ten days of the occurrence giving rise to the claim and wait an additional thirty days for a response before initiating any legal action. The sale and all terms are subject to California law. Any legal proceeding arising out of or relating to these terms and conditions or to the goods sold generally shall be brought solely and exclusively in the County of Los Angeles. In no event may Purchaser initiate any legal proceeding more than six months after the occurrence of the event giving rise to the dispute.

The above terms and conditions are the only ones governing this transaction and Seller makes no oral representations of any kind. These Terms and Conditions can only be modified in writing, signed by both Purchaser and Seller.

Contact [info@epicureanist.com](mailto:info@epicureanist.com) with any questions or visit [www.epicureanist.com](http://www.epicureanist.com)





732 S. Racetrack Road  
Henderson, NV 89015  
[www.epicureanist.com](http://www.epicureanist.com)

### **SERVICE & IMPORTANT NOTICE**

The manufacturer has a policy of continuous improvement on its products and reserves the right to change materials and specifications without notice.

### **WARNING:**

**Please do not place the unit within reach of children.  
For adult use only.**

Epicureanist is a trademark of Epicureanist LLC. All products, features, and services are subject to change without notice. We cannot guarantee the accuracy of the contents of this document. We disclaim liability for errors, omissions, or future changes.

©2019 Epicureanist LLC. All rights reserved.