

element
by vinotemp

Models:

27-BOTTLE WINE COOLER
EL-27WC-ID

54-BOTTLE WINE COOLER
EL-54WC-ID

21-BOTTLE WINE COOLER
60-CAN BEVERAGE CENTER
EL-2160BWC

General Operating Instructions

Remove all external and internal packaging from your refrigerator. Be sure that all parts have been included before discarding any packaging materials. You may want to keep the box and packing materials for use at a later date.

Upon receipt and inspection of unit, the supply cord must be replaced if it is damaged. Contact our customer service at 1-800-777-8466 or info@vinotemp.com.

- Let the unit rest UNPLUGGED for 24 hours once you have it placed in your home.
- Please fully read the instruction manual.
- Save these instructions.

**Please read and follow all safety rules
and operating instructions before using.**

**To register your product,
visit: <http://www.vinotemp.com/Warranty.aspx>
Register your warranty within 10 days of receiving the unit.
Please be sure to retain your proof of purchase.**

Table of contents

Safety instructions and warnings	2 – 3
Transportation and unpacking	4
Installation instructions	4 – 6
<i>Before installation of your appliance</i>	4
<i>Tools you will need</i>	5
<i>Installation dimensions (built-in)</i>	5 – 6
<i>Electrical requirements</i>	6
Parts and specifications	7 – 9
Operation	10 – 13
<i>Operating condition</i>	10
<i>Control elements</i>	10
<i>Setting the temperature</i>	10
<i>Functions</i>	11
<i>Shelves</i>	12
<i>Wine storage</i>	13
<i>Storage diagrams</i>	13
Cleaning and care	14
<i>Cleaning the appliance</i>	14
<i>Moving</i>	14
<i>Energy-saving tips</i>	14
Problems with your appliance?	15
Limited warranty	16 – 17

Safety instructions and warnings



IMPORTANT SAFETY INSTRUCTIONS

WARNING: Before the appliance is used, it must be properly positioned and installed as described in this manual. So read the manual carefully. To reduce the risk of fire, electric shock or injury when using the appliance, follow basic precautions, including the following:

- To prevent injury or damage to the appliance, it should be unpacked and set up by two people.
- In the event that the appliance is damaged on delivery, contact the supplier immediately before connecting to the power line.
- To guarantee safe operation, ensure that the appliance is set up and connected as described in these operating instructions.
- Disconnect the appliance from the power source if any fault occurs. Pull out the plug, switch off or remove the fuse.
- When disconnecting the appliance, pull on the plug, not on the cable.
- Any repairs and work on the appliance should only be carried out by the customer service department, as unauthorized work could prove highly dangerous for the user. The same applies to changing the power cable.
- Do not stand on the base, drawers or doors or use them to support anything else.
- Do not allow flames or sources of ignition to enter the appliance. When transporting and cleaning the appliance, ensure that the refrigerant circuit is not damaged. In the event of damage, make sure that there are no ignition sources nearby.
- Keep the room well ventilated.
- This appliance is not intended for use by persons (including children) with reduced physical, sensory or mental capabilities or lack of experience and knowledge unless they have been given initial supervision or instruction concerning use of the appliance by a person responsible for their safety. Children should be supervised to ensure that they do not play with the appliance.
- Do not store explosives or sprays using combustible propellants such as butane, propane, pentane, etc., in the appliance. Electrical components might cause leaking gas to ignite. You may identify such sprays by the printed contents or a flame symbol.
- Do not use electrical devices inside the appliance.
- Before you throw away your old appliance:
Take off the door. Leave the parts in place so that children may not easily climb inside.
- When disposing of your appliance, please choose an authorized disposal site.

Safety instructions and warnings

Children in the household

WARNING!

DANGER, RISK OF CHILD ENTRAPMENT!
Before you throw away your old appliance:
Take off the door. Leave the shelves in place
so that children may not easily climb inside.

- Never leave packaging material with children. There is a danger of poisoning or suffocation by the cardboard boxes and plastic sheets!
- This appliance is in no way a toy for children!
- If you will no longer be using the appliance, remove the doors and gasket seals and store in a safe place. In this way you will prevent the danger of children becoming trapped inside the appliance.
- Never allow children to operate, play with, or crawl inside the appliance.
- Child entrapment and suffocation are not problems of the past. Junked or abandoned appliances are still dangerous....even if they will “just sit in the garage a few days”.

Grounding instructions

DANGER & WARNING!

 Improper use of the grounding plug can result in a risk of electric shock.

- This appliance must be grounded.
- If the power socket of the home system is not grounded in accordance with the current legal regulations, connect the appliance to the grounding lead itself after consulting a specialized technician.

WARNING!

Do not use an extension cord with this Appliance.

- This appliance is equipped with a power cord having a grounding wire with a grounding plug. The plug must be plugged into an outlet that is properly installed and grounded.
- Consult a qualified electrician or service technician if the grounding instructions are not completely understood, or if doubt exists as to whether the appliance is properly grounded.
- If the outlet is a standard 2-prong wall outlet, it is your personal responsibility and obligation to have it replaced with a properly grounded 3-prong wall outlet.
- For best operation, plug this appliance into its own electrical outlet to prevent flickering of lights, blowing of fuse or tripping of circuit breaker.
- **Do not** under any circumstances cut or remove the third (ground) prong from the power cord.
- **Do not** use an adapter plug with this appliance.

Transportation and unpacking

- If the appliance is transported in a horizontal position, the oil from the compressor may leak into the cooling circuit. For this reason, allow the appliance to rest in a vertical position for 12 hours before turning it on, so that the oil flows back into the compressor.
- Remove the external packaging, remove the protective plastic film from the surface of the appliance (if used) and clean the external parts of the appliance with a cleaner designed for this purpose. Do not use steel wool or any coarse agents, which could irreparably damage the surface of the appliance. Carefully remove all papers and adhesive tape from the appliance, doors and other parts packed in polystyrene. Remove documents and accessories from inside the appliance.
- The packaging material is recyclable and is marked with a recycling symbol. For disposal, follow the local regulations. Packaging materials (plastic bags, polystyrene parts, etc.) must be kept out of the reach of children, because they present a possible source of danger.
- Carefully inspect the appliance. If you discover any faults, stop the installation and contact the vendor.

Installation instructions

NOTE: The appliances can be installed as either built-in or free-standing units. For free-standing installation, allow at least 4" of clearance at the back, sides and top of the unit to permit the proper air circulation to cool the compressor and condenser. Even for built-in installation, certain clearances are necessary for optimal operation. In this case, allow 3/16" on both sides, 2" at the rear and 1/16" at the top to ensure proper ventilation. Take care that the air vent at the front of the appliance is never covered or blocked in any way.

Before installation of your appliance

- The placement of the appliance must meet the requirements in the section *Operating conditions* on page 7 and must include a stable floor with a load-bearing capacity corresponding to the weight of the appliance.
- Level the appliance using the adjustable feet. Ensure there is a gap between the bottom edge of the appliance and the ground, so that there is sufficient circulation of air. This will ensure the optimal performance of the cooling system.
- Check whether any coolant circulation pipes have been damaged during the installation.
- Use the appliance only for the purposes for which it has been designed.
- The appliance must be located on a rigid and even surface. In this way you will ensure free circulation of the coolant and effective operation of your appliance.
- If possible, place the appliance in a cool, well ventilated and dry room.
- Do not locate the appliance in direct sunlight or in a room with a high ambient temperature, or in the vicinity of any sources of direct heat, such as a radiator or oven. This would cause the compressor to work harder, resulting in a substantially higher power consumption level.

Installation instructions

FOR YOUR SAFETY

While performing installations described in this section, gloves and safety glasses or goggles should be worn.

Tools you will need:

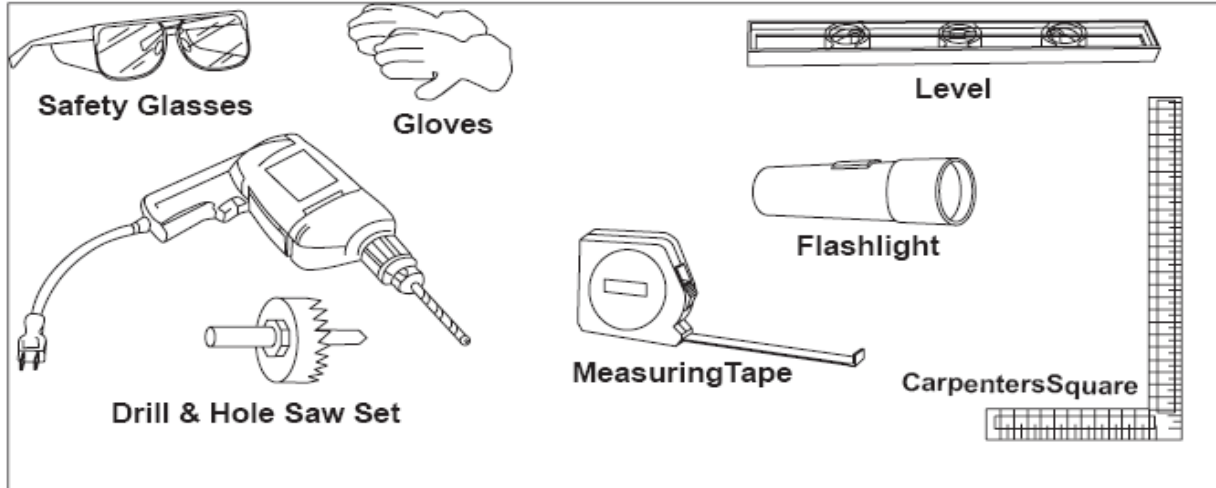

Installation dimensions (mm/in)

If your appliance is to be built-in, follow the diagram and chart below for appropriate dimensions.

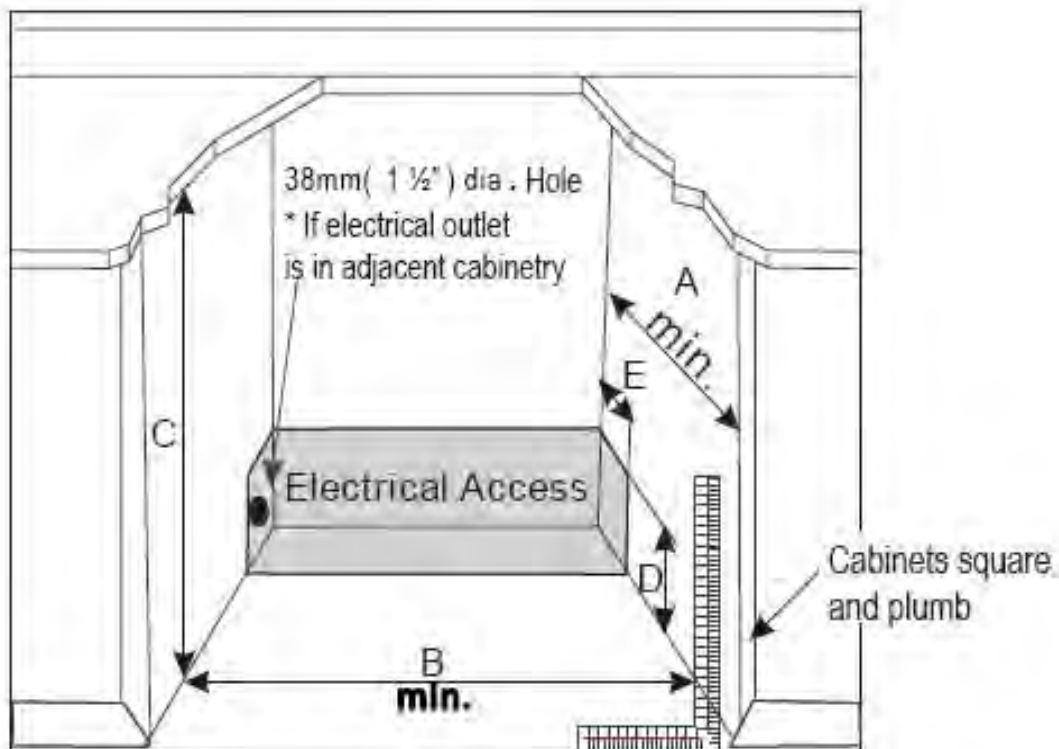

Installation instructions

Model	EL-27WC-ID	EL-54WC-ID	EL-2160BWC
A	660mm (26")	660mm (26")	660mm (26")
B	387mm (15¼")	610mm (24")	610mm (24")
C	883mm (34 ¾")	883mm (34 ¾")	883mm (34 ¾")
D	152mm (6")	152mm (6")	152mm (6")
E	51mm (2")	51mm (2")	51mm (2")

Electrical requirements

A 115 Volt (AC only) 60 Hz grounded electrical supply equipped with a 15- or 20- amp fuse or circuit breaker is required. It is recommended that a separate circuit serving only your appliance be provided. Use outlets that cannot be turned off by a switch or pull chain. Connect this appliance to a 3-prong power supply outlet that has a ground terminal. If you only have a 2-prong outlet, have it replaced by a qualified technician with an outlet that meets the local codes. **DO NOT USE AN EXTENSION CORD.** Required nominal voltage and frequency are indicated on the rating plate. The connection to the power supply and grounding has to be made according to current standards and regulations.

PARTS AND SPECIFICATIONS

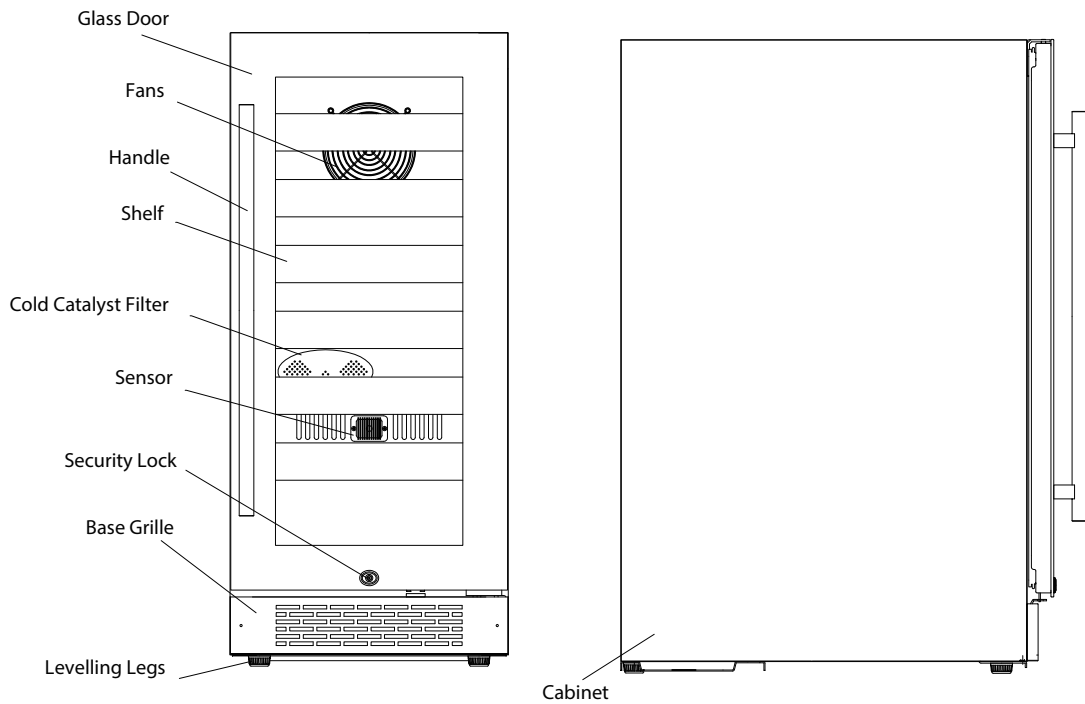

Model No.	EL-27WC-ID
Voltage	AC 115V
Frequency	60 Hz
Ambient Temperature Range	60° - 90°F
Control Temperature Range	39° - 64°F
Refrigerant	R134a/1.59 Oz
Input Power	130W
Volume	93L
Net Weight	77 lbs
Gross Weight	102 lbs
Dimensions (W x D x H)	14 15/16" x 23 5/16" x 34 1/16"
Box Dimensions (W x D x H)	16 15/16" x 26 3/8" x 37 3/16"

*Note: This wine cellar is designed to store standard Bordeaux 750 ml 300mm height bottles. Storing large and/or oddly shaped bottles (including champagne and sparkling wine bottles) will decrease the capacity of your wine cellar.

PARTS AND SPECIFICATIONS

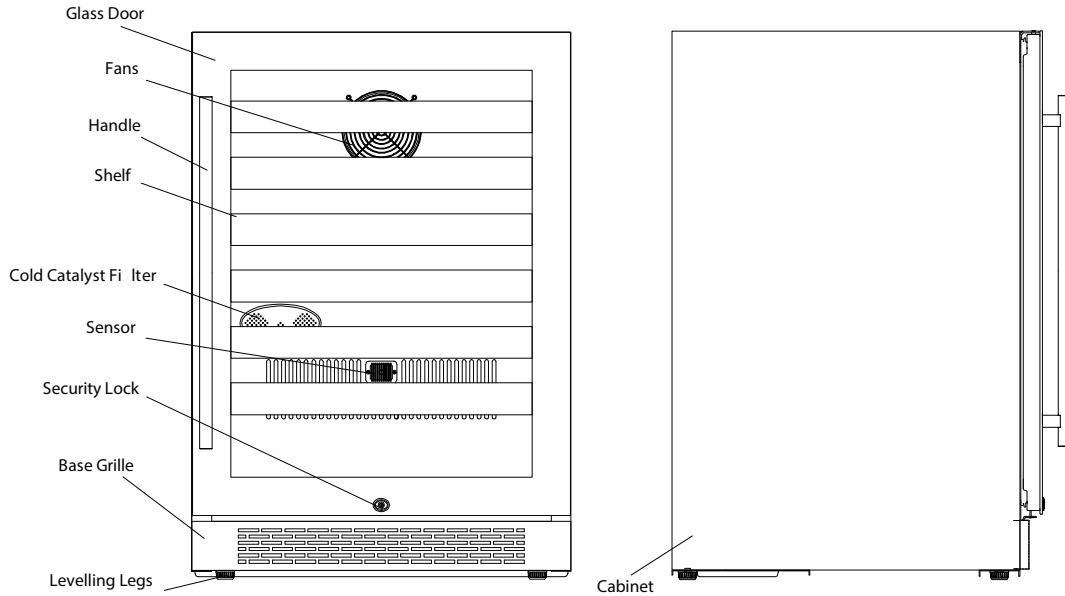

Model No.	EL-54WC-ID
Voltage	AC 115V
Frequency	60 Hz
Ambient Temperature Range	60° - 90°F
Control Temperature Range	39° - 64°F
Refrigerant	R134a/2.29 Oz
Input Power	160W
Volume	162L
Net Weight	114 lbs
Gross Weight	154 lbs
Dimensions (W x D x H)	23 13/16" x 23 5/16" x 34 7/16"
Box Dimensions (W x D x H)	26 3/8" x 27 3/8" x 37 13/16"

*Note: This wine cellar is designed to store standard Bordeaux 750 ml 300mm height bottles. Storing large and/or oddly shaped bottles (including champagne and sparkling wine bottles) will decrease the capacity of your wine cellar.

PARTS AND SPECIFICATIONS

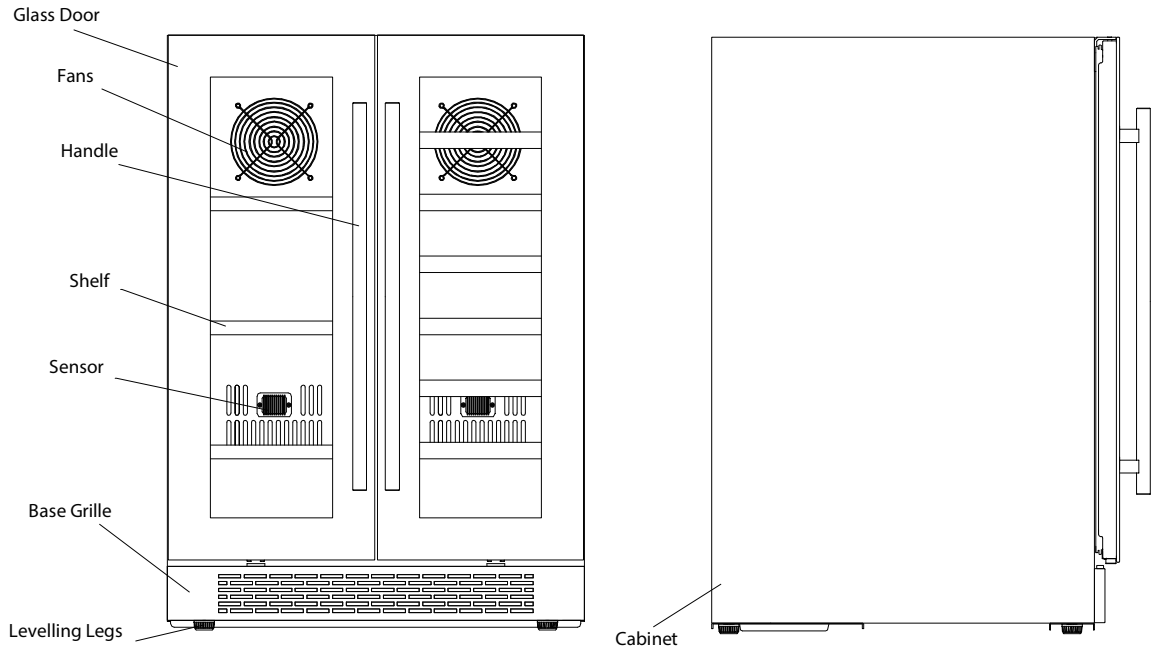

Model No.	EL-2160BWC
Voltage	AC 115V
Frequency	60 Hz
Ambient Temperature Range	60° - 90°F
Control Temperature Range	39° - 64°F
Refrigerant	R134a/3.0 Oz
Input Power	160W
Volume	146L
Net Weight	120 lbs
Gross Weight	154 lbs
Dimensions (W x D x H)	23 7/8" x 25 1/4" x 34 5/8"
Box Dimensions (W x D x H)	27 1/4" x 27 1/2" x 37"

*Note: This wine cellar is designed to store standard Bordeaux 750 ml 300mm height bottles. Storing large and/or oddly shaped bottles (including champagne and sparkling wine bottles) will decrease the capacity of your wine cellar.

Operation

Operating conditions

Proper operation of the appliance is guaranteed only if the following conditions are met:

- The temperature in the room where the appliance is located conforms to the climate class stated on the appliance's rating label.
- Maximum ambient relative humidity: RH75%.
- The appliance must be placed at a sufficient distance from heat sources (e.g., ovens, central heating, direct sunlight, etc.).
- The appliance must be located in such a place that it is protected against the effects of weather.
- Regular maintenance is performed according to the instructions in this user's manual.
- The ventilation openings on the appliance must not be covered.
- Correct installation (e.g. leveling, the capacity of the system corresponds to the specifications on the rating label of the appliance).

**For Models: EL-27WC-ID,EL-54WC-ID
EL-2160BWC**

Control elements







- 1) “ 3s” button





To turn the unit ON and OFF, press and hold this button for approximately 3 seconds.

- 2) “ 3s” button

Energy conservation button: Pressing this button for 3 seconds will turn the energy conservation mode ON or OFF. In this mode, the LED light and display will turn off, and the °C/°F light will be on.

- 3) “ ” indicator light
Shows that the compressor is in operation.
- 4) “°C/°F” indicator light
The temperature scale is changed by pressing the “°C/°F” button.
- 5) “ ” button
Used to increase (warm) the temperature in steps of 1°F (or 1°C).
- 6) “ ” button
Used to decrease (cool) the temperature in steps of 1°F (or 1°C).
- 7) “°C/°F” button
Press this button to switch the indicator light between °C/°F.
- 8) “ ” button
Turns the interior light ON and OFF. (If you use this button, the light is no longer controlled by the reed switch, and remains ON.)
- 9) LED display
Display screen shows the temperature setting.

Setting the temperature

- Insert the power plug into a properly grounded power socket.
- Use the  /  buttons to set the desired temperature of the appliance. Each time the  /  buttons are pressed, the temperature will increase / decrease by 1°F (or 1°C).
- You can set the temperature in the range of 39°F to 64°F (or 4°C to 18°C) .

Operation

Functions

■ Temperature Memory Function

If the power is suddenly lost, the set temperature will be saved by the unit. Once the power is back on, the unit will be at the same set temperature.

■ “Close Door” Reminder Function

When you forget to close the door or the door is not fully closed, there will be warning alarm after 5 minutes.

■ Temperature Alarm Function

If the interior temperature is higher than 73°F (23°C), “HI” is shown on the display panel and the buzzer alarm sounds continuously after one hour. This indicates that the inner temperature is too high, and you should look for the reason. If the inner temperature is lower than 32°F (0°C), “LO” is shown on the display panel; the alarm and the malfunction indicator light go on at the same time.

Note:

If too many bottles are put in at once or the door has not been closed tightly, the unit will display the "HI" signal on the display panel. This is normal. Please wait 5 minutes after closing the door and “HI” will disappear.

- It is normal that the cabinet shows “HI” or “LO” from time to time. If it occurs frequently or lasts for a long time, you can restart the unit by unplugging it, then re-plugging after 5 minutes. If the problem occurs again after restarting, please contact customer service.
- Before reconnecting the power, wait 3 to 5 minutes. Otherwise you could damage your appliance. If you attempt to start the appliance before the end of this time delay, the appliance will not turn on.
- If you turn on the appliance for the first time or after a restart, or after it has been out of operation for a long time, there may be a temperature difference between the temperature inside the appliance and that on the LED display. This is a normal event caused by the duration of the activation period. Leave the appliance turned on for several hours and the temperatures will stabilize during operation.

Shelves

(Models : EL-2160BWC)



WARNING!

Do not cover racks with aluminum foil or any other material that will prevent adequate air circulation within the cabinet.

- To prevent damaging the doors or gasket seals, open the doors wide when removing the shelves.
- For easier handling of bottles, it is necessary to pull the shelf out by at least 1/3. The sides of the shelves are equipped with protective stoppers which prevent bottles from falling from the shelves.
- When removing / inserting the shelves from / into the liner, lift one side of the shelf as shown in the picture below and pull the shelf out towards you, or push it in when inserting it, until one side is securely seated on the liner.

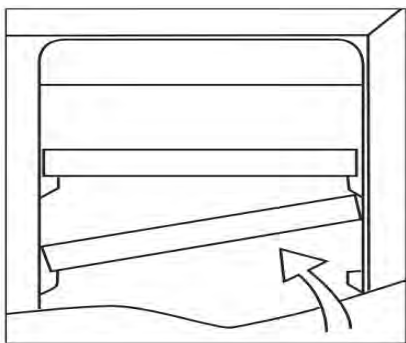

(Model:EL-27WC-ID,EL-54WC-ID)

- To prevent damaging the door gasket, make sure to have the door all the way opened when pulling shelves out of the rail compartment. For easy access to the bottles, you must pull the shelves approximately 1/3 out of the rail compartment.
- To remove the shelves out of the rail, pull each shelf approximately 1/3 out, lift the whole shelf as shown in the Fig. A / Fig. B. Hold on to both rails and push the shelf until the notch aligns with the metal nail on each side of the shelf track, lift the shelf then pull the shelf out towards you.

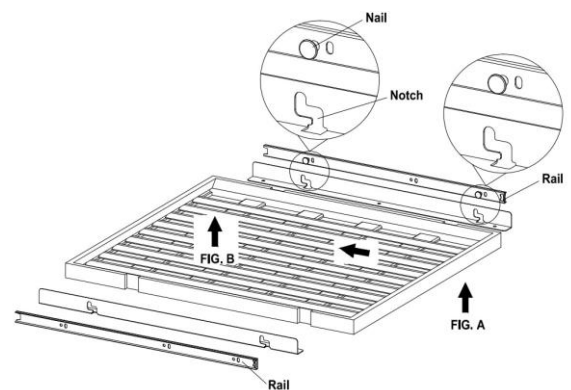

Operation

Wine Storage (For 750ml Bordeaux bottles)

Model: EL-27WC-ID

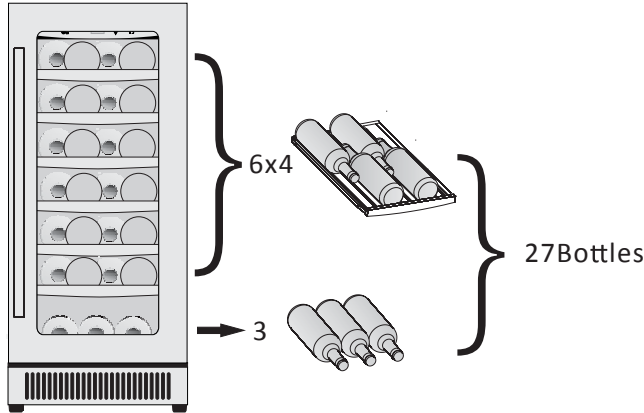

Model: EL-54WC-ID

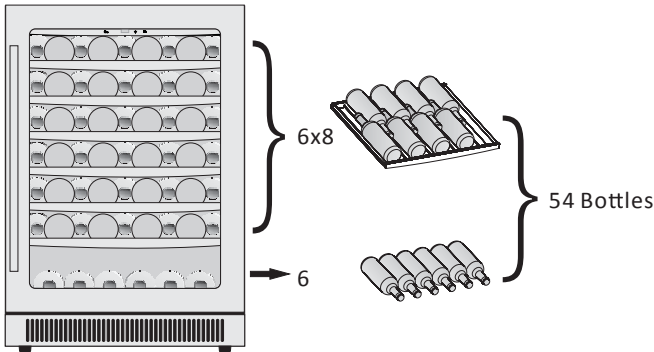

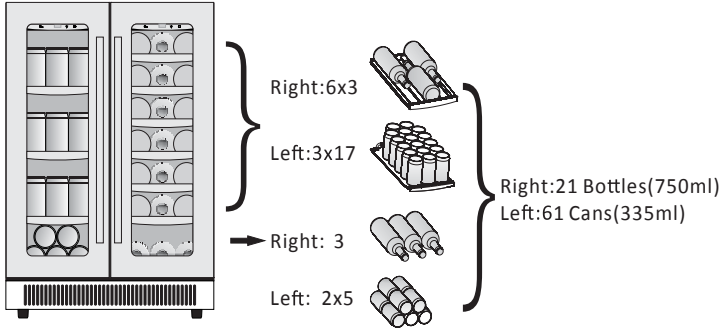

Model: EL-2160BWC





Cleaning and care

Cleaning the appliance



 **DANGER & WARNING!** 

Before commencing to clean the appliance disconnect it from the power source.

- Wipe the internal surface of the appliance with a soft sponge lightly dipped in a table salt solution. Add 2 tablespoons of table salt to a quart of warm water.
- Wash the shelves in warm water with a small amount of kitchen dishwashing liquid, rinse and wipe dry. Allow the wooden shelves (if the appliance has them) to dry completely before returning them to the wine cooler.
- Use a glass cleaner to clean the glass surfaces and a commercially available stainless-steel cleaning agent for the stainless-steel surfaces.
- All parts that you wash with a soft sponge lightly dipped in water must be properly wiped dry.
- Wipe the outer surface with a soft sponge lightly dipped in water with a small amount of dishwashing liquid. Wipe dry using a clean cloth.
- Dust and drink can cause door gaskets to stick to the cabinet and tear when you open the door. Wash gaskets with a mild detergent and warm water. Rinse and dry thoroughly after cleaning.

 **Note** 

- Do not use steel wool or sponges with steel wool on stainless steel surfaces. They could damage the surface.
- Do not use cleaning waxes, concentrated cleaning agents, bleaches or cleaning products containing kerosene on the plastic

 **DANGER & WARNING!** 

 Never clean appliance parts with flammable fluids. The fumes can create a fire hazard or explosion.

or rubber parts.

- Never use paper towels or window cleaners on the plastic parts.

Moving

- Remove all contents before moving the appliance.
- Use tape to secure freely moving parts such as racks inside the appliance.
- To prevent damage, screw in the leveling feet.
- Tape the door shut.
- Ensure that the appliance always remains in a vertical position while being transported. To prevent the appliance from damage during transport you can cover it with a blanket or other soft cloth.

Energy-saving tips

- Locate the appliance away from sources of heat and out of direct sunlight.
- Ensure sufficient ventilation. Under no circumstances should you cover the ventilation openings.
- Only open the door when necessary. Do not leave the door open for a long time or open the door too often.
- If the appliance will not be used for several months, remove all items and turn off the appliance. Clean and dry the interior thoroughly. To prevent odor and mold growth, leave the door open slightly, blocking it open if necessary.

Problems with your appliance?

You can solve many common appliance problems easily, saving you the cost of a possible service call. Try the suggestions below to see if you can solve the problem before calling the servicer.

Troubleshooting guide

Problem	Possible cause
Appliance does not operate.	Not plugged in. The appliance is turned off. Tripped circuit breaker or blown fuse.
Appliance is not cold enough.	Check the temperature control setting. External environment may require a higher setting. The door is opened too often. The door is not closed completely. The door gasket does not seal properly.
Turns on and off frequently.	The room temperature is higher than normal. A large amount of contents has been added to the appliance. The door is opened too often. The door is not closed completely. The temperature control is not set correctly. The door gasket does not seal properly.
The light does not work.	Not plugged in. Tripped circuit breaker or blown fuse. The bulb has burned out. The light button is OFF.Or  Energy saving button is on.
Vibrations.	Check to be sure the appliance is level.
The appliance is making too much noise.	The rattling noise may come from the flow of the refrigerant, which is normal. As each cycle ends, you may hear gurgling sounds caused by the flow of refrigerant in your appliance. Contraction and expansion of the inside walls may cause popping and crackling noises. Check that the unit is level.
The door will not close properly.	The unit is not level. (2-Door model is uneven: loosen the bottom screws of the left door, then push the door to left. The left door will lower.The door was reversed and not properly re-installed. The gasket is dirty. The shelves are out of position.

Terms and Conditions

Vinotemp International Corp. ("Seller") and the person or entity that acquires these goods from Seller ("Purchaser") hereby fully agree to the following terms and conditions of the sale: Shipping fees are the responsibility of the Purchaser whether freight prepaid or freight collect. Seller assumes responsibility for the goods sold to the Purchaser until the goods have reached Purchaser's delivery address (FOB Destination) and the delivery receipt is signed clear. Seller is not responsible for the carrier's late delivery, missed delivery, unpaved roads, remote locations, stairs, elevators, narrow door openings and other such issues in attempting to fit or deliver the goods into the Purchaser's location. Delivery to remote locations may require additional fees. Remote location may be defined at the discretion of the carrier as more or less than 50 miles from the nearest major city. Purchaser assumes all responsibility for additional costs related to freight such as access, measurement, installation, hook-up, wiring, moving and storage of the goods, flight of stairs, carrier's inability to safely and/or adequately deliver, inability to use the building elevator to lift the goods, narrow openings, along with any additional costs to deliver or redeliver the product properly. Make sure to review access to the property and size of the product ordered. The transportation of all goods is subject to the terms and conditions which the carrier imposes on Purchaser. Installation is the responsibility of the Purchaser. If white glove delivery was ordered and cannot be performed properly, or access is hindered in any way, Purchaser agrees to accept delivery curbside. If Purchaser will call or pays for their own freight responsibility transfers to the Purchaser when the Purchaser or Purchasers freight company picks up the unit from Seller.

White Glove Delivery: White glove delivery is defined as follows: Delivery will be to the 1st floor only, easy access and **NO STAIRS**, Doors aligned, feet attached (if necessary) and removal of packaging. Customer agrees that any additional request will result in additional charges. White glove delivery is not included for returns or Non-New Units.

Note: Shipping and handling fees for products over 300lbs are for threshold delivery. White glove delivery is available by request for an additional fee. Freight discussed is Continental USA (excluding Alaska), cost is additional please email us at info@vinotemp.com for a quote.

All damages must be noted at time of delivery. If a bill is signed that there is no damage, buyer accepts delivery as free and clear. Any claim for damages of the goods, when FOB Destination, that incurred during shipment by the carrier are insured and handled directly with the carrier by the Seller if noted on the receipt and notified within 48 hours of delivery. OPEN AND INSPECT YOUR DELIVERY. When FOB Destination, if the item is damaged by the freight company, and Purchaser cancels rather than accepts a replacement, the order can be cancelled by paying for freight costs both ways and a 35% restocking fee for stocked items. No cancellation or refunds on custom/made or made to order products. When shipped 3rd Party (FOB Warehouse), Purchaser assumes all responsibility for delivery, payment of freight and freight claims for damages during shipment. Manufacture defects will be handled directly with Seller, subject to the limited warranty below.

All sales are final. Unless authorized in writing by the Seller, Purchaser may not return the goods under any circumstance. If Seller agrees in writing to take back stocked goods, there will be a restocking/service fee that is 35% of the purchase price of the goods and freight both ways (product must be new, unused, and in original packaging). If Purchaser returns goods claiming that the goods are defective and goods are found to be in working condition by the Seller, Purchaser is liable for the cost of freight both ways plus and a service fee that is 35% of the purchase price of the goods. Built-to-Order and Custom products are non-returnable, non-refundable. Purchaser must notify Seller of non-conforming goods within 48 hours of receipt, after which time all goods are deemed accepted by the Purchaser. If an order has been placed and production has not started, cancellation of your order will be a 15% charge. If Purchaser tenders payment with a check that has insufficient funds (NSF), a collection fee plus NSF fee of \$50 will be added to the invoice, which Purchaser agrees to pay promptly. If Purchaser puts a stop payment on a check or credit card for any reason, Purchaser agrees to pay for all costs associated with the Seller's collection or litigation of such a claim, including, without limitation, general and special damages, court costs and attorneys' fees. Finance charges begin the date of invoice. Title to the goods reverts back to the Seller in the case of non-payment of goods or services. All fees and costs to retrieve the product, cost of freight, legal costs, collection fees and court fees, credit card fees and interest rate of 18% (annual rate) will be the responsibility of the Purchaser. In a credit card dispute, Purchaser assumes and must immediately pay any "credit card arbitration" fees and chargeback fees which the credit card companies charge at the time of the chargeback. Any disputes not resolved within 30 days from the invoice date will be reported to credit reporting agencies.

LIMITED WARRANTY: Seller warrants that the goods will be free of defects in materials and workmanship as follows:

Furniture style (wood) wine cabinets made in the U.S.: all cooling unit parts only for a period of 5 (five) years; cabinetry and labor (uninstalled) for a period of 12 (twelve) months.

Metal cabinet wine units: parts and labor for cooling system and cabinetry for a period of 12 (twelve) months.

For Designer Series units: parts and labor for a period of 12 (twelve) months from date of sale, compressor parts 5 years.

Thermoelectric Units: 90 (ninety) days (including Wine Coolers, Beer Dispensers, Humidor, Portofino Wood Cellars, and Refrigerators).

Wine-Mate Split and Ducted Systems and other installed cooling units are parts only for 1 year, no labor. Self Contained Wine-Mate Cooling Systems are 5 years parts, 1 year labor. Removal and reinstallation of cooling units is not included.

Wine Accessories, Racking Systems, Parts and Other miscellaneous items is a 30 day warranty.

Il Romanzo units: Warranty 90 (ninety) days. Replacement part 12 (twelve) months from the date of sale.

Non-New Units (Scratch & Dent/Refurbished/Floor Models), warranty for compressor units is 90 days from your dated invoice and 30 days for thermoelectric units (parts for function only, not cosmetic defects). These units are refurbished and sold as is; Purchaser assumes risks to the quality and performance of goods and assumes the costs of all necessary service or repair not covered herein. Extended warranties via New Leaf may not be purchased on Non-New Units. Delivery is curbside. Upgrades in delivery will require an additional fee.

Element Grills (via Element Products LLC), grills have a 1 year parts warranty and a thirty day limited parts warranty on grill accessories.

If a purchaser claims a product is "defective" with regards to refrigeration, Purchaser must obtain a letter from a qualified refrigeration technician at the Purchaser's cost to verify that the unit was installed properly, with proper ventilation and the unit is truly malfunctioning due to a manufacturing defect.

Removal or re-installation of a unit is not included in warranted costs. Purchaser's exclusive remedy is limited at Seller's option to repair or replace defective part[s] with either new or reconditioned part[s]. Purchaser is responsible for shipping the unit pre-paid to a designated facility and Seller will pay return shipping charges in the continental United States for items repaired under warranty within 12 (twelve) months from date of sale. The returned unit must be packaged correctly, with enough protection to ensure the unit is not further damaged. Oversized or lack of packaging is not permitted and will be refused. Replacement or exchanged units will be returned to Purchaser through curbside delivery only. Any redelivery fees are the Purchasers responsibility.

Since the natural variation in texture, density, grain, color, tone, and shade of wood is unavoidable; Seller does not guarantee the texture, color, tone, or shade of the wood: nor does seller guarantee the colorfastness of wood or against peeling, chipping, cracking, or scratching. Note: Unfinished wood is subject to warping; all wood surfaces must be sealed before placing cellar into service. Make sure doors are aligned by reviewing the owner's manual. Improper repair or placement of the unit will void the warranty. Any third party repair facility must be pre-approved in writing by Seller, before providing replacement parts under warranty.

Storage Fees: When having an item serviced by a Vinotemp service technician at the Vinotemp facility, Purchaser agrees to pick up their repaired item or make arrangements for return shipping within a 60-day period once they have been notified by Vinotemp through phone call, email, or letter that their unit is ready for pick up. If the item remains in the Vinotemp warehouse after 60 days but no longer than 120 days, the Purchaser will incur additional storage fees of 2%. After 120 days in storage, the item will become property of Vinotemp. Warranty period is from the date of sale (not from shipping, delivery, nor installation).

All completed cabinetry, racking, or other custom work must be picked up or shipped within a period of 14 days after Vinotemp has notified the Purchaser by phone call, email, or letter. Any completed cabinetry, racking, or other custom work stored longer than 14 days will incur an additional storage fee. After 120 days, the product will become property of Vinotemp.

This Limited Warranty does not cover damage due to such things as accident, misuse, abuse, mishandling, neglect, acts of God, fires, earthquakes, floods, high winds, government, war, riot or labor trouble, strikes, lockouts, delay of carrier, unauthorized repair, or any other cause beyond the control of the Seller, whether similar or dissimilar to the foregoing. Seller is not responsible for any damages caused to Purchaser's property resulting from the goods. This limited warranty applies only inside the Continental US (Alaska, Puerto Rico, Hawaii and other territories/countries are not warranted).

Purchaser understands and acknowledges that the goods sold here are wine cellars, cigar humidors, and/or other similar units which house wine or cigars or other items. Purchaser assumes all risk of using these units, including risk of spoilage, humidity variations, temperature variations, leaks, fire, water damage, mold, mildew, dryness and similar and any other perils that might occur.

Seller is not responsible for incidental or consequential damages, and there are no warranties, expressed or implied, which extend beyond the Limited Warranty described above. Warranty and liability are non-transferable. The implied warranties of merchantability and of fitness for a particular purpose are hereby expressly disclaimed. Some states do not allow the exclusion of incidental or consequential damages, or a waiver of the implied warranties of fitness and/or merchantability, so the above limitations may not apply to you. This warranty gives you specific legal rights and you may also have other rights which vary from state to state. Seller disclaims any indemnification for claims of infringement of any intellectual property of protectable nature. In the event of any dispute between Seller and Purchaser arising out of or relating to these terms and conditions or to the goods sold generally, Purchaser must first file a written claim with Seller within ten days of the occurrence giving rise to the claim and wait an additional thirty days for a response before initiating any legal action. The sale and all terms are subject to California law. Any legal proceeding arising out of or relating to these terms and conditions or to the goods sold Purchaser shall bring, solely and exclusively in the County of Los Angeles. In no event may Purchaser initiate any legal proceeding more than six months after the occurrence of the event giving rise to the dispute. Seller may make non-payment claims until debt is paid in full.

Any dispute or claim relating in any way to these to the Terms and Conditions, the Website, or any products or services sold or distributed by or through this Website, store, or catalog will be resolved by binding arbitration, rather than in court, except that you may assert claims in small claims court if your claims qualify. The Federal Arbitration Act and federal arbitration law apply to the Terms and Conditions. We each agree that any dispute resolution proceedings will be conducted only on an individual basis and not in a class, consolidated or representative action. If for any reason a claim proceeds in court rather than in arbitration we each waive any right to a jury trial. We also both agree that you or we may bring suit in court to enjoin infringement or other misuse of intellectual property rights.

The above terms and conditions are the only ones governing this transaction and Seller makes no oral representations of any kind. These Terms and Conditions can only be modified in writing, signed by both Purchaser and Seller.

08.29.16

SERVICE & IMPORTANT NOTICE

Upon receipt and inspection of unit, the supply cord must be replaced if it is damaged. Contact our customer service at 1-800-777-8466 or info@vinotemp.com.

The manufacturer has a policy of continuous improvement on its products and reserves the right to change materials and specifications without notice.

WARNING:
Please do not place the unit within reach of children.
For adult use only.

Contact info@vinotemp.com with any questions or visit:
www.vinotemp.com

Vinotemp[®]

17621 S. Susana Road
Rancho Dominguez, CA 90221
www.vinotemp.com

Vinotemp is a registered trademark of Vinotemp International. All products, features, and services are subject to change without notice. We cannot guarantee the accuracy of the contents of this document. We disclaim liability for errors, omissions, or future changes.

© 2016 Vinotemp International. All rights reserved.