

# Assembly instructions for 7ft 1 2B-B/D Module.

## Fasteners.

1 2B-B/D 7

### Tools needed:

- (1) Hammer
- (1) Power drill
- (1) Level
- \*Suggested 18 gauge Brad Gun with 1/4" brad nails will make install easier.

Parts List:



- (8) 2 1/2" Phillips screws for attaching to wall.
- (3) 1 1/4" Joining Screws to attach to other modules.
- (64) 1 1/4" Shelf Screws

(30) nails



(8) Drywall Inserts

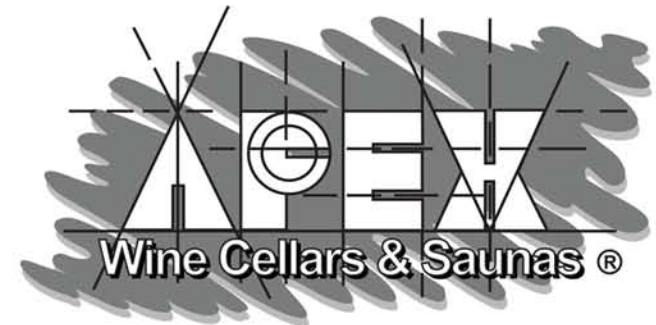
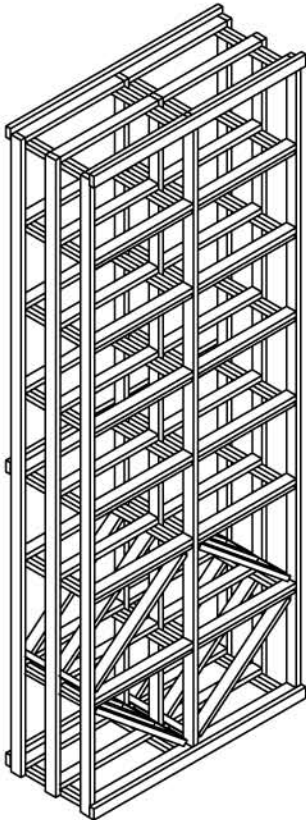

# Assembly instructions for 7ft 12B-B/D Module. Racking.

12B-B/D-7

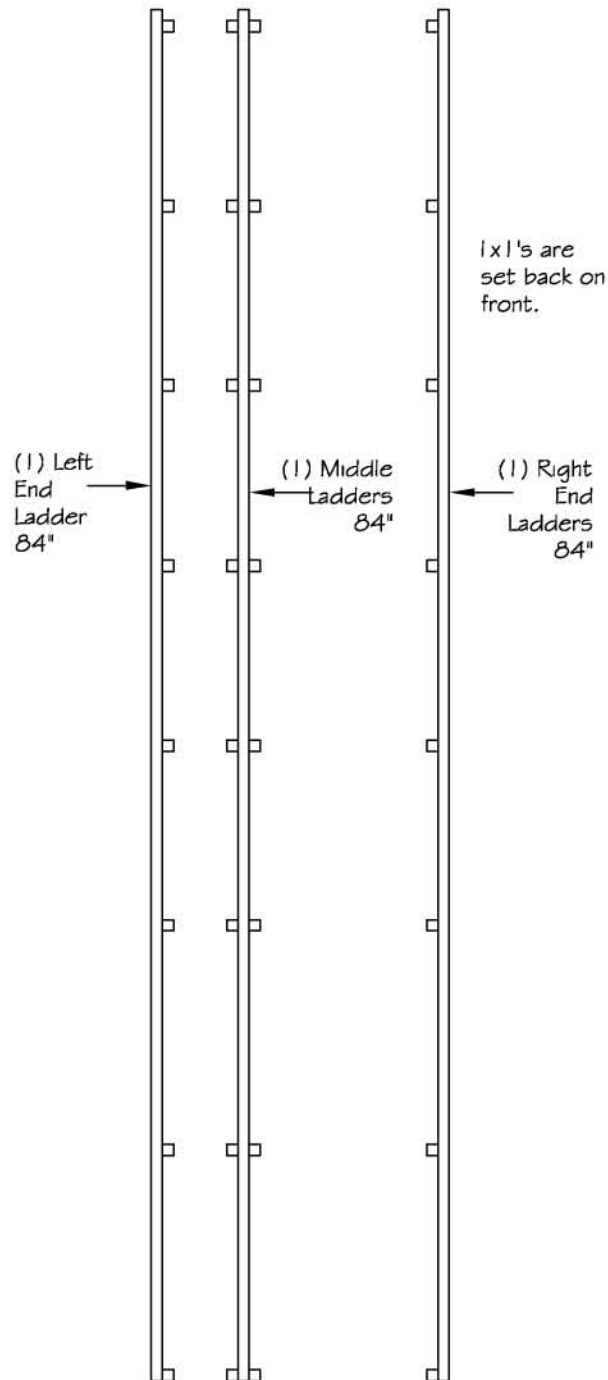
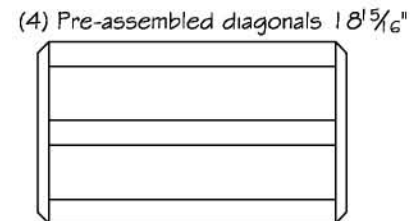
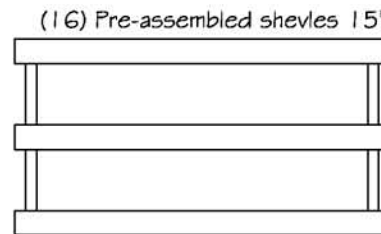
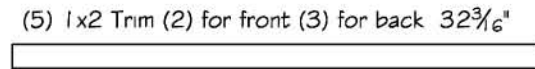
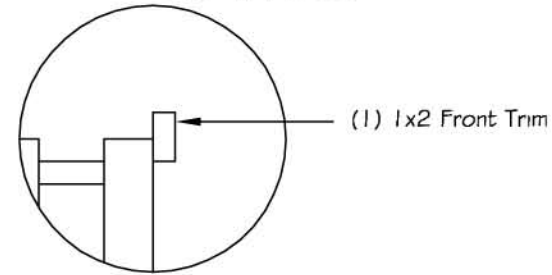
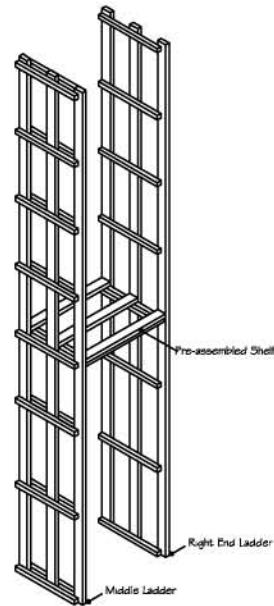

Diagram of 1x2 Front Trim in the "up" position



# step 1



Step 1: (Attaching middle shelf to right end ladder and middle ladder)  
 Arrange the right end ladder and the middle ladder, making sure the set back on the rungs are facing forward, and place one of the pre-assembled shelves on the fourth rung. The front of the shelf has a 1x1 trim piece fastened under the 1x2 cross support. From the inside, either brad nail or screw the shelves onto the rung in two places.

# step 2

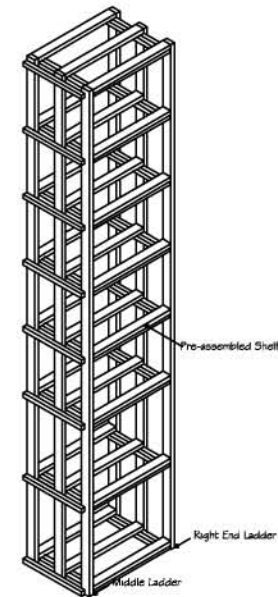

Step 2: (Attaching five more shelves to end ladder and middle ladder)  
 Place the seven shelves onto the remaining seven rungs and attach in the same way as in Step 1. Make sure the shelves with the trim pieces are facing the front.

# step 3

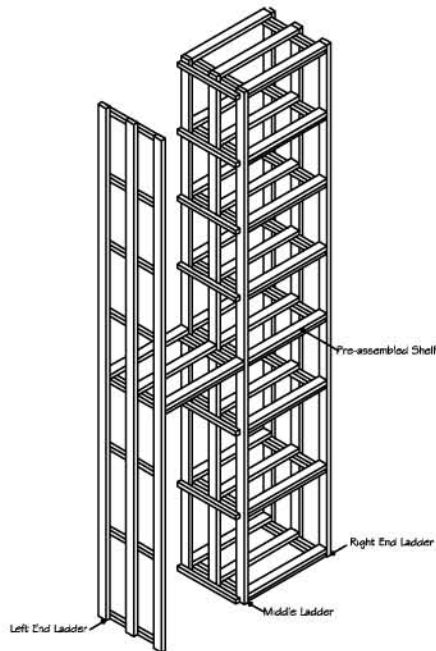

Step 3: (Attaching middle shelf to left end ladder and middle ladder)  
 Arrange the left end ladder next to the middle ladder, making sure the set back on the rungs are facing forward. The front of the shelf has a 1x1 trim piece fastened under the 1x2 cross support. Place a pre-assembled shelf on the third rung. From the inside, either brad nail or screw the shelves onto the rung in two places.

# step 4

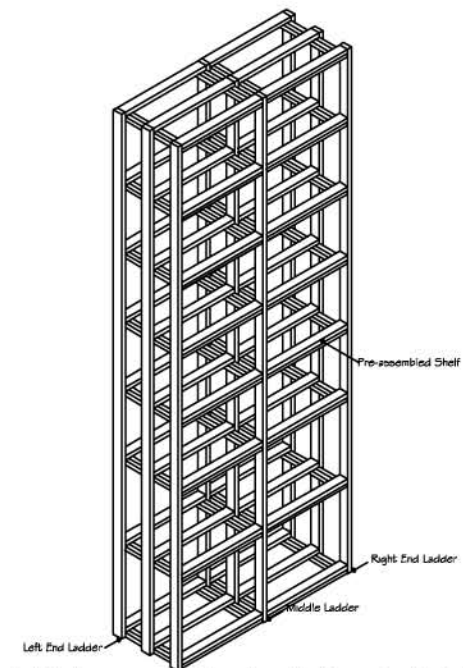

Step 4: (Attaching remaining shelves to end ladder and middle ladder)  
 Place the seven shelves onto the remaining seven rungs and attach in the same way as in Step 1. Make sure the shelves with the trim pieces are facing the front.

## step 5

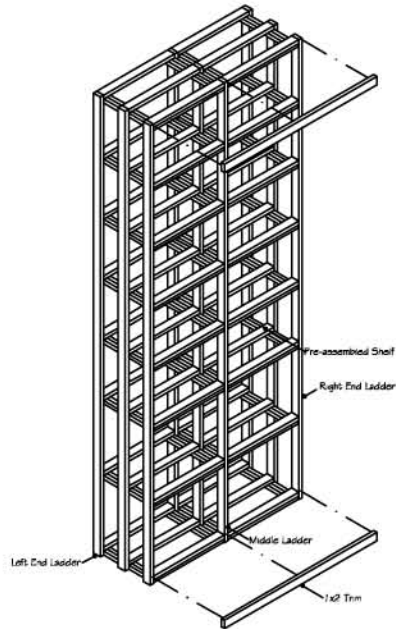

### Step 5: (Attaching 1x2 trim to front of rack)

Take two of the 1x2x24 1/2" trim pieces and attach them to the 1st and 8th shelf from the bottom to the top. The top 1x2 should be placed so it is 'up'. The bottom 1x2 is directly on the floor.

## step 6

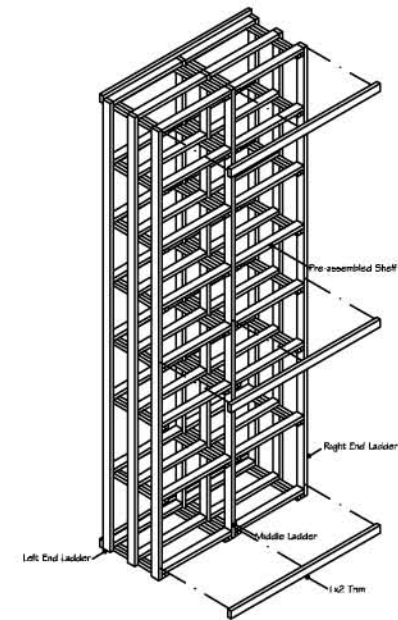

### Step 6: (Attaching 1x2 trim to back of rack)

Take the last three 1x2x24 1/2" trim pieces and attach them to the 1st, 5th and 8th shelf from the bottom to the top. All of these should be placed so the trim is 'up'. The exposed area of the trim will be used to screw through into the wall.

## step 7 Finish

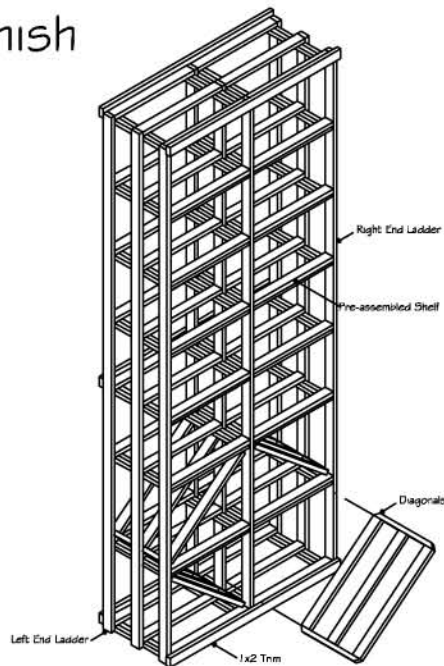

### Step 7: (Inserting diagonal)

Take all four pre-assembled diagonals and insert them into the four larger openings in the bottom.

## step 8 Finish

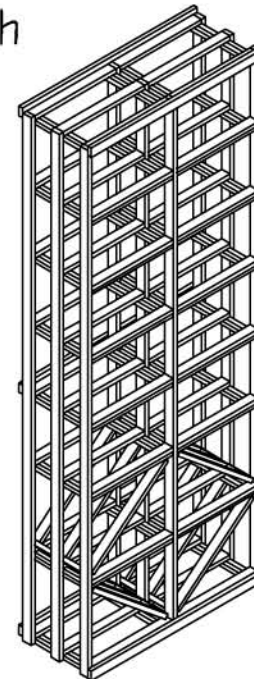

### Step 8: (Finish)

Fasten to the wall through the back supports using the 2 1/2" screws and using a level to make sure the rack is mounted square on the wall.

# Fastener Placement Guide

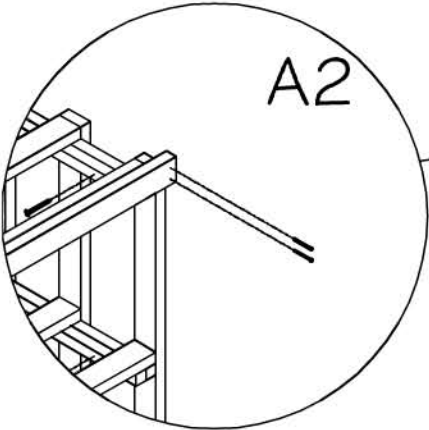

A2

A2

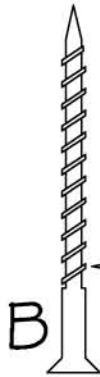
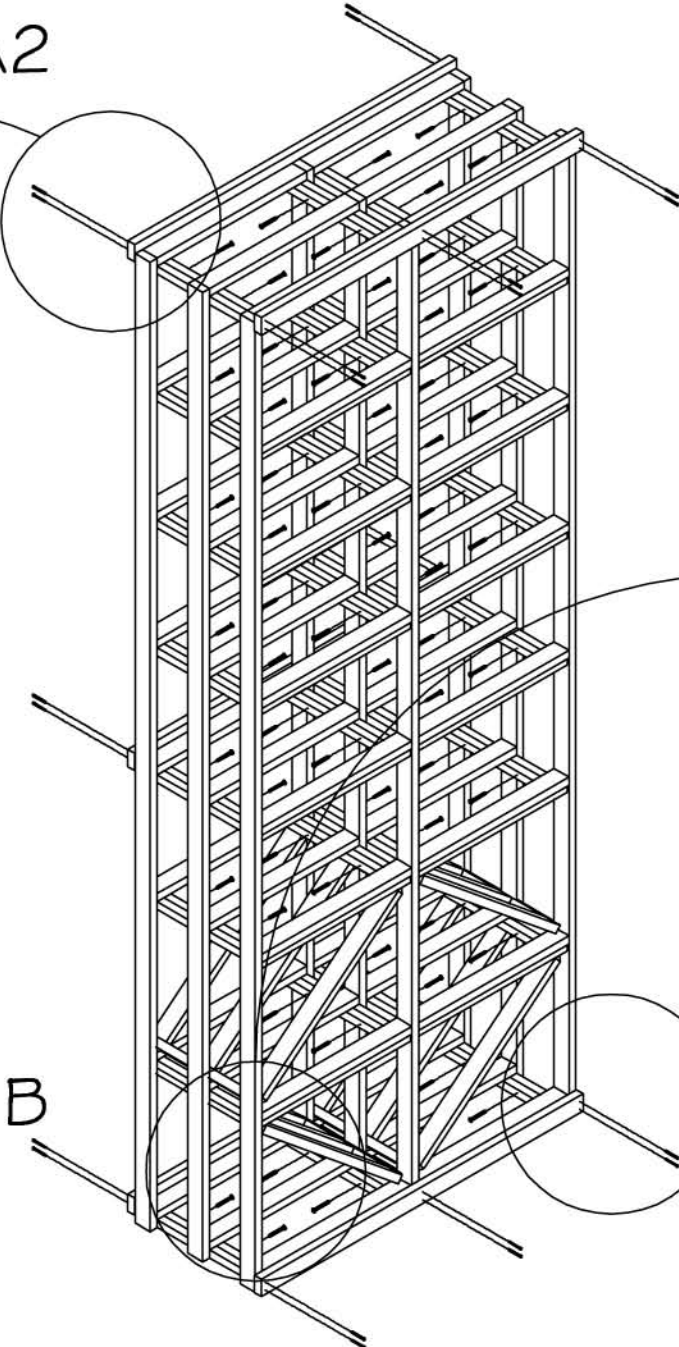

B

(30) nails  
-Nail one at every point where the front and back trim intersect a ladder as shown.

(64) shelf screws  
-Place shelf on 1x1's and screw through 1x1's from the side.



A

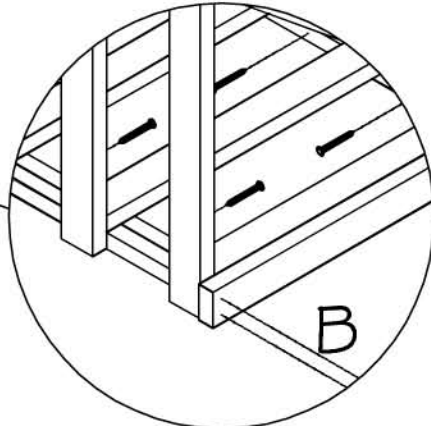

B

A1

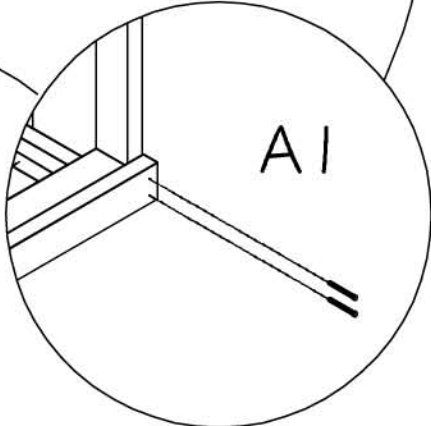

A1

B