

# APPLICATION TIPS

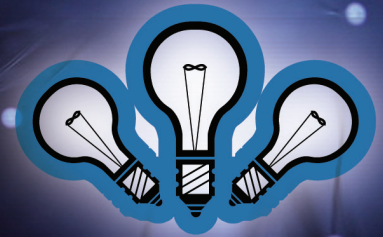

Version 1.8

## CHOOSING THE CORRECT LENS

### Introduction

The first consideration when choosing a lens is the application. Knowing this will help determine the best lens for a process. This tip sheet describes the different focus lenses offered by Universal Laser Systems including spot size, focal length, and wavelengths supported.



### Overview

This sheet describes how optics work and describes specific details of each of the lenses. This sheet will cover each lens kit offered by Universal Laser Systems for every laser system made including the correct calibration process for each lenses focus tool.

### Outline

- How Optics Work
- HPDFO™ 10.6 $\mu$ m CO<sub>2</sub> (High Power Density-Focusing Optics)
- 1.5" Lens Kit (10.6 $\mu$ m CO<sub>2</sub>)
- 2.0" Lens Kit (10.6 $\mu$ m CO<sub>2</sub>)
- 2.5" Lens Kit (10.6 $\mu$ m CO<sub>2</sub>)
- 3.0" Lens Kit (10.6 $\mu$ m CO<sub>2</sub>)
- 4.0" Lens Kit (10.6 $\mu$ m CO<sub>2</sub>)
- HPDFO™ (High Power Density-Focusing Optics) 1.06 $\mu$ m Multi-Wavelength Fiber Lens Kit
- 2.0" Lens Kit 1.06 $\mu$ m Multi-Wavelength Fiber
- 4.0" Lens Kit 1.06 $\mu$ m Multi-Wavelength Fiber
- Focal tool calibration

## How Optics Work

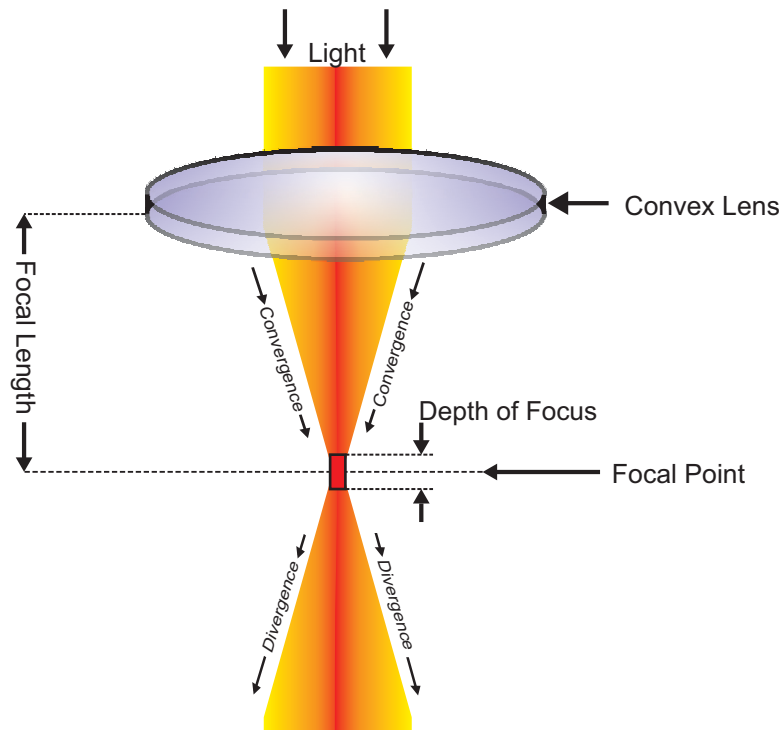

### How Laser Optics Work

ULS Laser systems use plano-convex lenses to focus laser light. Our laser focus lenses are optimized for specific wavelengths of laser light. Laser light enters a convex lens and begins to converge to a focal point, upon crossing the focal point, the light then diverges out again. The range light converges and then diverges out again, depends on the lenses focal length. The shorter the lenses focal length, the more quickly it will converge/diverge, the smaller the focal spot will be and the shorter the depth of focus will be (depth of focus is the usable range of the focus beam). Shorter focal length lenses will provide smaller focal spot sizes but will require more accurate focusing and are more sensitive to flatness of material than longer focal length lenses.

The focal point is the point to which the laser light is at its smallest size and this is what determines the ultimate resolution and quality that can be achieved with each lens. This point also called "Spot" or "Spot size" is also the location at which the power density of the laser is highest. Different lens types will have different spot sizes, different depths of focus (focus tolerance) and different focal lengths producing different effects.

### Examples:

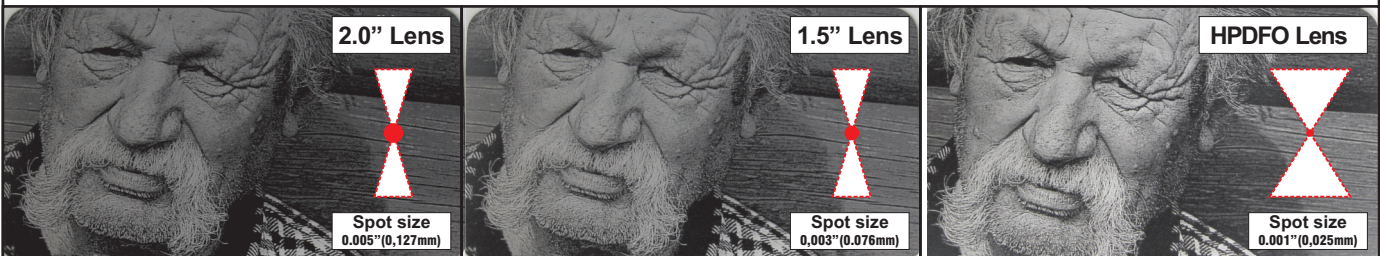

Here is an engraving of the same image, laser processed on black anodized aluminum, with the same laser system, the same laser wattage and the same laser processing settings, with three different laser lenses. As the focal spot gets smaller, sharper details are seen in the laser image that is processed, producing a brighter more detailed image.

The following pages will describe the details of all lenses sold by Universal Laser Systems, Inc. and where they will best benefit an application or material.

## High-Power Density-Focusing Optics™ (HPDFO) 10.6μm CO<sub>2</sub>

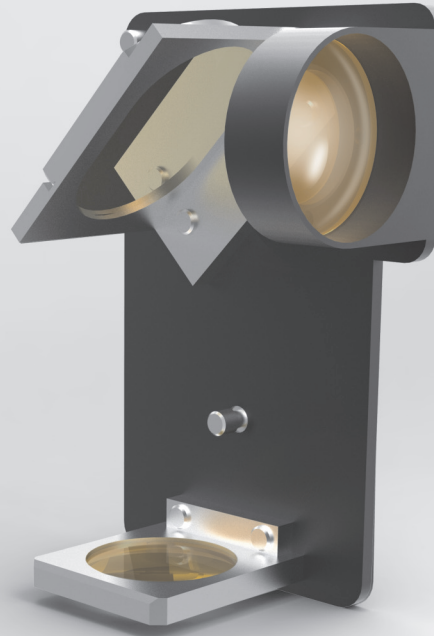
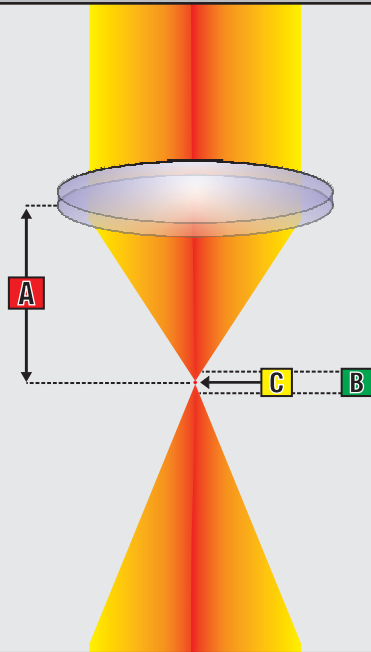

<b>A</b>	Average Focal Length:	<b>2.0" (50,8mm)</b>
<b>B</b>	Tolerance:	<b>+/- 0.03" (+/- 0,762mm)</b>
<b>C</b>	Average Focus point:	<b>0.001"(0,025mm)</b>

**High-Power Density-Focusing Optics (HPDFO)** uses a patented method to expand the laser beam within the focusing carriage. This expansion allows the beam to be focused to much smaller focal spot but at the same focal length as a standard 2" lens, suitable for intricate, tight-tolerance engraving and for direct marking on some metals, in addition to sharper images and expanded material processing capability.

### What it does:

Universal's HPDFO produces a smaller, more focused spot than a standard optical laser beam delivery system producing the smallest spot possible for incredible detail and the finest kerf on thin material cutting. HPDFO increases the power density of the laser to achieve the effects of a laser of much higher power allowing for materials like steel to be directly marked. Depending on the type of material being processed, and the desired effect, the effective spot size produced by this option can be as small as 1/5th the size of a standard 2.0 inch focusing lens. This small size allows for the highest possible detail to be achieved when laser processing materials.

### Benefits of the HPDFO Lens:

- Patented lens kit
- Highest possible resolutions (sharpest details)
- High power density marks directly on steel products
- Field up-gradable on any ULS system 1998 and newer
- Can be interchanged with other lenses as needed

### Limitations of the HPDFO Lens:

- Poor thick cutting ability (No thicker than 1/8" or 3,18mm)
- Will not work with SuperSpeed or Dual Head options
- Limited focal range tolerance (very high divergence)
- Higher cost lens kit

### Examples:



*Extreme Detail (Rubber)*

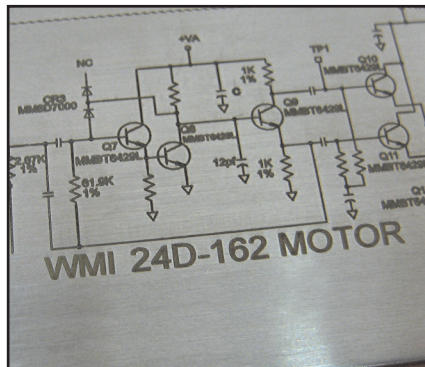

*Direct Metal Marking (Stainless Steel)*



*Highest resolution photos (Painted Acrylic)*

# 1.5" Lens Kit (10.6µm CO<sub>2</sub>)

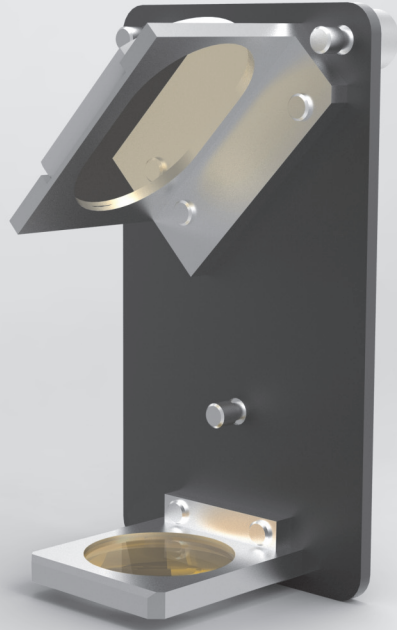
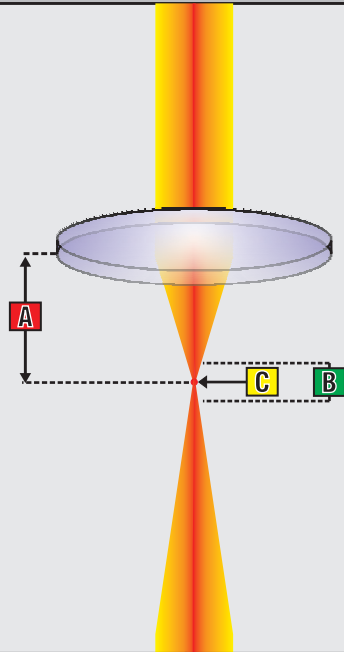

<b>A</b>	<b>Average Focal Length:</b>	<b>1.5" (38,1mm)</b>
<b>B</b>	<b>Tolerance:</b>	<b>+/- 0.075" (+/- 1,905mm)</b>
<b>C</b>	<b>Average Focus point:</b>	<b>0.003"(0,076mm)</b>

**1.5" Lens Kit** assembly has been designed for the very high resolution engraving and etching of extremely small fonts and photos. This lens will give an additional 1/2" (12,7mm) to the table height (Z axis) allowing for taller parts to be processed however because it is the closest lens to the work area, it can have a greater chance of being contaminated due to that proximity to laser processing. The 1.5" tolerance is low and cannot handle much deviation from the focus point. Because of high divergence it will not be a good thick cutting lens on materials thicknesses over 0.2" or 5,08mm. Can be interchanged with any other available lens and is available on all PLS and VLS series systems as well as most older generations of Universal Laser Systems.

**What it does:**

Universal's 1.5" lens kit produces a small, focused beam or spot. Depending on the type of material being processed, and the desired effect, the effective spot size produced by this option is about 40% smaller than the 2.0 inch focusing lens allowing for higher details and quality during the engraving and marking process.

**Benefits of the 1.5 inche Lens:**

- High resolution for detailed laser processing
- Field up-gradable on supported systems, 1996 and newer
- Can be interchanged with other lenses as needed
- Shorter focal length gives 1/2" (12,7mm) more distance on your Z axis (table height)
- Thin kerf on thin material cutting applications

**Limitations of the 1.5 inch Lens:**

- Closer to work area, contamination more likely
- Poor cutting ability for thick materials (No thicker than 0.2" or 5,08mm)
- Limited focal range tolerance (high divergence)
- Not available on PLS 6MW, ILS and XLS Series lasers

**Examples:**



*Detail Marking (Anodized Aluminum)*

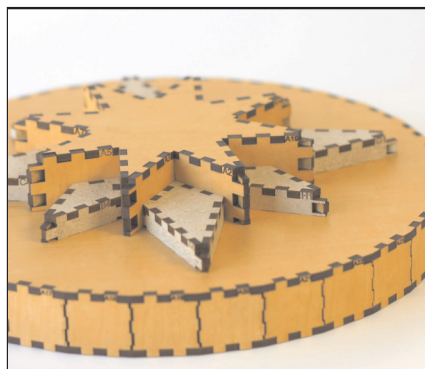

*Thin Cutting (1/8" 3,175mm MDF Wood)*



*Photo (Clear Cast Acrylic)*

## 2.0" Lens Kit (10.6 $\mu$ m CO<sub>2</sub>)

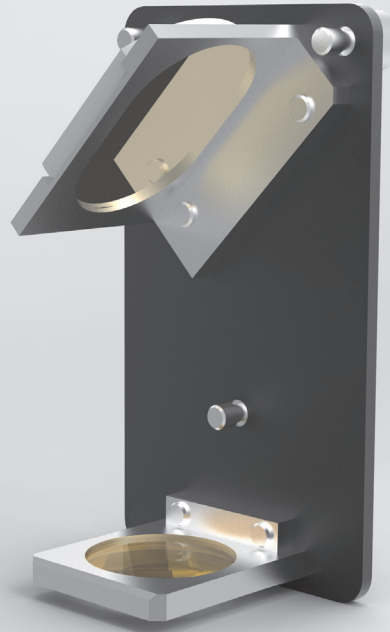
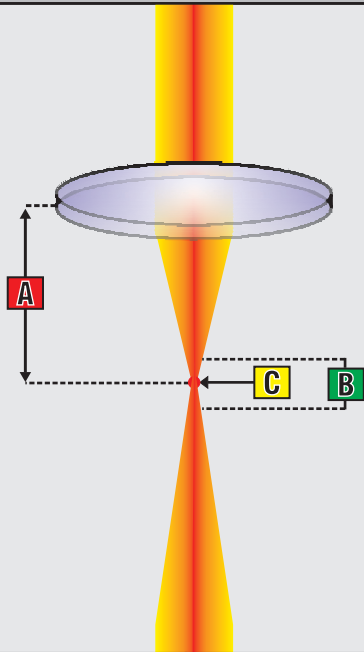

<b>A</b>	<b>Average Focal Length:</b>	<b>2.0" (50,8mm)</b>
<b>B</b>	<b>Tolerance:</b>	<b>+/- 0.1" (+/- 2,54mm)</b>
<b>C</b>	<b>Average Focus point:</b>	<b>0.005" (0,127mm)</b>

**2.0" Lens kit:** The 2.0" inch lens provides a combination of amazing engraving and marking details combined with a very good cutting ability. It is because of this that the 2.0" lens is the most general lens kit that comes "STANDARD" with all ULS laser systems (unless specified otherwise). Can be interchanged with any other lens and is available on all Universal Laser Systems .

### What it does:

This is the all purpose lens that will produce high quality engraving and marking as well as consistent cutting, up to 1/2" (12,7mm) or more in thickness depending on the type of material being processed. If there is a question on what lens to use this will be the most practical choice.

### Benefits of the 2.0 ince Lens:

- The all purpose engraving and marking and cutting lens
- Very good cutting lens, up to 1/2" (12,7mm)
- Supported on every ULS laser system ever made
- Can be interchanged with other lenses as needed
- Best lens for both cutting and engraving thicker materials

### Limitations of the 2.0 inch Lens:

- Not the best lens for very high resolution details
- Creates tapered edge when cutting over 1/2" (12,7mm)
- Only lens that works with ILS universal camera registration

### Examples:



Quality Engraving (Maple Wood)



All purpose Cutting (Cast Acrylic)



Photo Marking (Leather)

## 2.5" Lens Kit (10.6 $\mu$ m CO<sub>2</sub>)

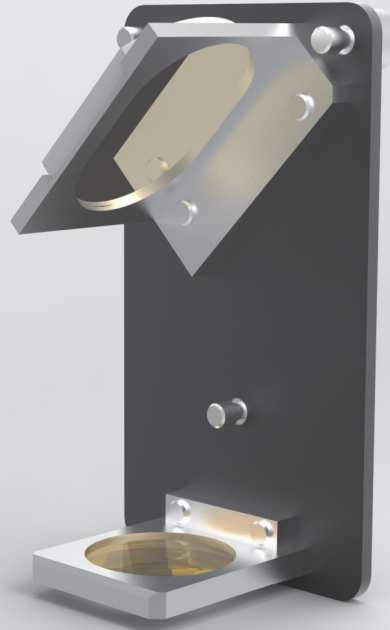
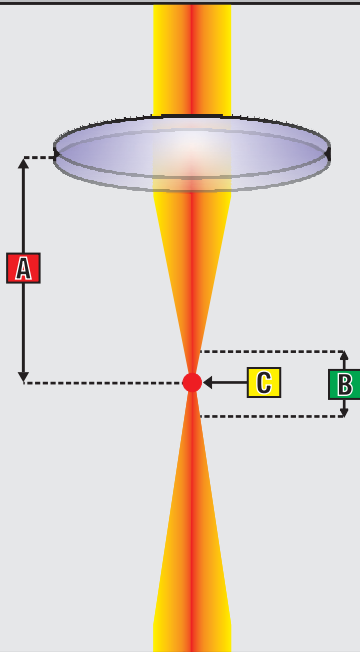

<b>A</b>	<b>Average Focal Length:</b>	<b>2.5" (63,5mm)</b>
<b>B</b>	<b>Tolerance:</b>	<b>+/- 0.15" (+/- 3,81mm)</b>
<b>C</b>	<b>Average Focus point:</b>	<b>0.007"(0,178mm)</b>

**2.5" Lens Kit:** The 2.5" inch lens provides good engraving detail though not as good as the shorter lenses. This is the lens kit used when clearance or tolerance becomes an issue. This lens has a longer focal length and great tolerance making it excellent for cutting thick materials up to 5/8" (15,875mm) depending on the material. This lens also gives you an additional 1/2" (12,7mm) clearance over the standard 2.0" however it also reduces your total Z axis (table height) by that same 1/2" (12,7mm). Can be interchanged with any other lens and is available on all PLS and VLS platform series systems.

### What it does:

This is the best lens for thick, consistent straight edge cutting when clearance and tolerance becomes an issue, while still providing good quality engraving and marking. Cutting with this lens up to 3/4" (19,5mm) in thickness depending on the type of material being processed.

### Benefits of the 2.5 inch Lens:

- Great cutting of thick materials up to 5/8" (15,875mm)
- When clearance and tolerance exceeds the 2.0" lens
- Gives an additional 1/2" (12,7mm) clearance over the 2.0"
- Field up-gradable on supported systems, 1996 and newer
- Can be interchanged with other lenses as needed

### Limitations of the 2.5 inch Lens:

- Lower detailed engraving (Larger spot size)
- Not recommended for photo engraving
- Reduces your Z axis (table height) by 1/2" (12,7mm)
- Not available for VLS desktop, PLS 6MW, ILS and XLS series laser systems

### Examples:



Deep Engraving (Wood Rolling Pins)



Thick Cutting (1/2" 12,7mm Cut Acrylic)



Tolerance Marking (River Stones)

## 3.0" Lens Kit (10.6μm CO<sub>2</sub>)

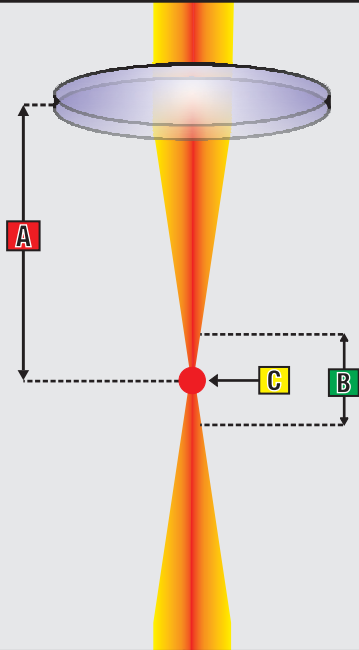

<b>A</b>	<b>Average Focal Length:</b>	<b>3.0" (76,2mm)</b>
<b>B</b>	<b>Tolerance:</b>	<b>+/- 0.18" (+/- 4,57mm)</b>
<b>C</b>	<b>Average Focus point:</b>	<b>0.010"(0,25mm)</b>

**3.0" Lens kit:** The 3.0 inch lens provides good detail. This is the lens kit used when clearance or tolerance becomes an issue; this lens gives you an additional 1" (25,4mm) clearance over the standard 2.0" lens kit, but still maintains good engraving quality. This lens has a longer focal length and a greater tolerance making it excellent for cutting thick materials up to 3/4" (19,5mm) or more depending on the material. Can be interchanged with any other lens and is available only on the ILS and XLS series systems.

### What it does:

This is the best lens for thick consistent straight edge cutting when clearance and tolerance becomes an issue, while still providing good quality engraving and marking. Cutting with this lens up to 3/4" (19,5mm) or more in thickness depending on the type of material being processed. The lens is further from the surface of the material reducing the chance the lens can become contaminated with residue.

### Benefits of the 3.0 inch Lens:

- Great thick cutting lens up to 3/4" (19,5mm)
- When clearance and tolerance exceeds the 2.0" lens
- Field up-gradable on supported systems
- Can be interchanged with other lenses as needed

### Limitations of the 3.0 inch Lens:

- Lower quality engraving and marking (large spot size)
- Not recommended for detailed engraving
- Reduces your Z axis (Table height) by 1" (25,4mm) from the standard 2.0" lens kit
- Only available for ILS and XLS Series laser systems

### Examples:



*Tolerance Engraving (Wood Checkering)*

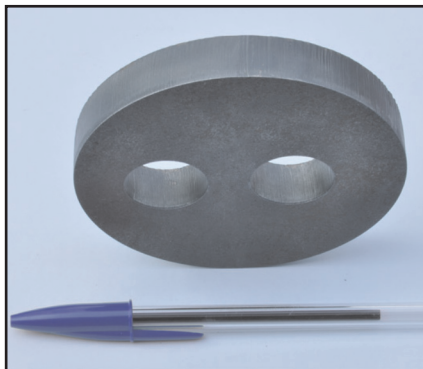

*Thick Cutting (1/2" 12,7mm Cut Rubber)*



*Depth Engraving (Beach Wood)*

## 4.0" Lens Kit (10.6μm CO<sub>2</sub>)

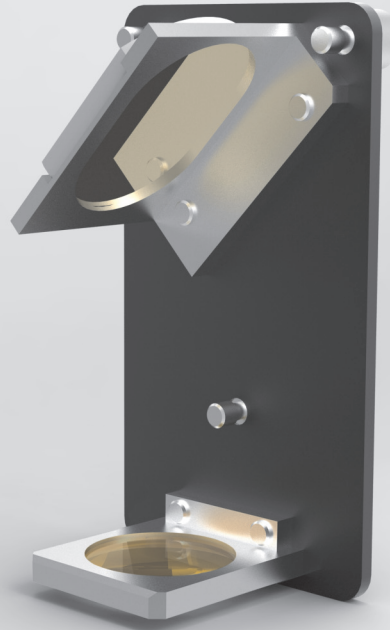
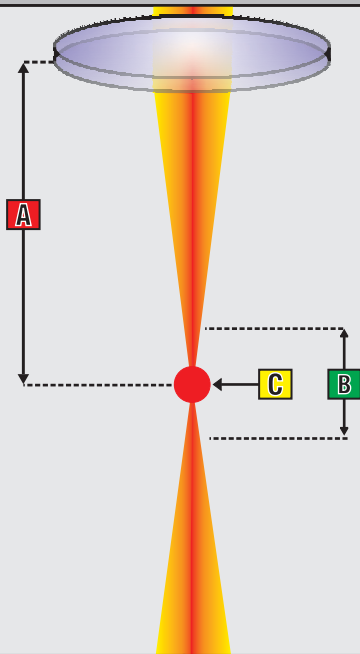

<b>A</b>	<b>Average Focal Length:</b>	<b>4.0" (101,6mm)</b>
<b>B</b>	<b>Tolerance:</b>	<b>+/- 0.20" (+/- 5,08mm)</b>
<b>C</b>	<b>Average Focus point:</b>	<b>0.012"(0,304mm)</b>

**4.0" Lens kit:** This is the longest focal lens produced by ULS. This lens kit is used when clearance or tolerance becomes an issue, and no shorter lens will work, this lens gives you an additional 2" (50,8mm) clearance over the standard 2.0" lens kit however the engraving detail is low due to its large spot size. This lens has the longest focal length and the best tolerance of any other lens kit offered making it excellent for cutting thick materials up to 1" (25,4mm) or more depending on the material. Can be interchanged with any other lens and is available only on the VLS Platform and the PLS series systems.

### What it does:

The 4.0" inch lens produces a focused beam over a longer vertical distance, which makes it ideal when engraving within a recessed area of a product, such as inside a bowl or box. This is the best lens for thick, consistent straight edge cutting when clearance and tolerance is an issue. This lens is still able to mark and engrave though the quality is lower due to its large focus point size. This lens is much further from the surface of the material reducing the chance that this lens can become contaminated with residue.

### Benefits of the 4.0 inch Lens:

- Great thick cutting lens up to 1" (25,4mm)
- When clearance and tolerance exceeds all other lenses
- Furthest from surface of material reducing contamination
- Field up-gradable on supported systems 1996 and newer
- Can be interchanged with other lenses as needed

### Limitations of the 4.0 inch Lens:

- Not recommended for detailed engraving
- Reduces your Z axis (Table height) by 2" (25,4mm)
- Not available on VLS Desktop, ILS or XLS systems
- Will not work with SuperSpeed or Dual Head options

### Examples:



Low Tolerance Engraving (Wood Bottles)



Very Thick Cutting (1" 25,4mm Acrylic)

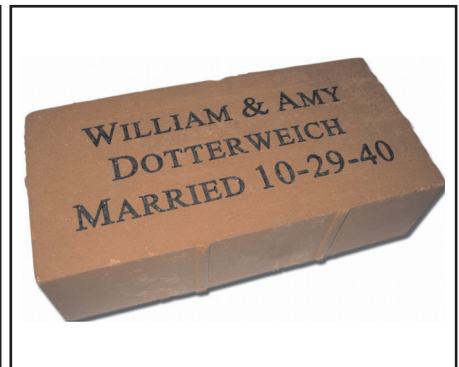

Marking (Clay Brick)



# High-Power Density-Focusing Optics™ 1.06μm FIBER (HPDFO)

This is a Multi-Wavelength lens kit, it works with both Co2 (10.6 um) and Fiber (1.06um) laser wavelengths. This sheet is only for the Fiber Wavelength, refer to the Co2 HPDFO section when using that wavelength on the Multi-Wavelength laser system.

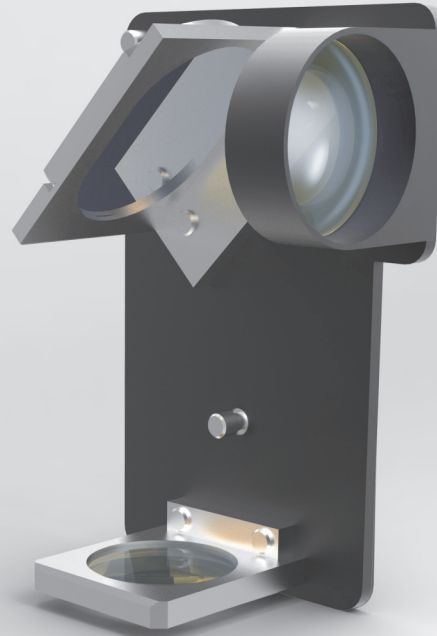
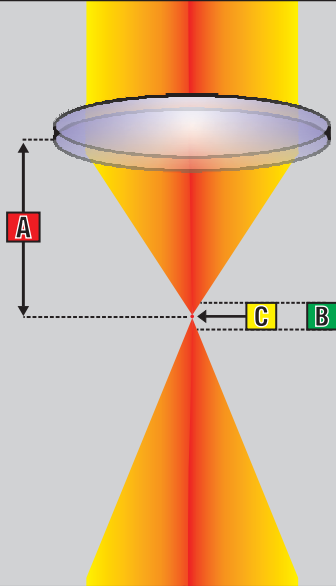

<b>A</b>	<b>Average Focal Length:</b>	<b>2.0" (50,8mm)</b>
<b>B</b>	<b>Tolerance:</b>	<b>+/- 0.01" (+/- 0,254mm)</b>
<b>C</b>	<b>Average Focus point:</b>	<b>0.00012" (0,003mm)</b>

**High Power Density Focusing Optics (HPDFO) Fiber laser lens kit** uses a patented method to expand the laser beam within the focusing carriage. This expansion allows the beam to be focused into a much smaller focal spot. This increased power density of the laser provides a laser with much higher power.

### What it does:

Universal's HPDFO produces a smaller, more focused beam "spot" than a standard optical laser beam delivery system producing the smallest spot possible of any laser system made. Designed for incredible detail smaller than the human eye can see on some materials. This lens kit can also be used for direct penetration marks into all metals, thin metal cutting, and the thinnest kerf on thin cutting.

### Benefits of the HPDFO Fiber Lens:

- Patented lens kit
- Best lens for cutting very thin metals
- Highest possible resolutions, able to process micro marking
- Field up-gradable on PLS6MW and XLS 10MWH
- Can be interchanged with other lenses as needed

### Limitations of the HPDFO Fiber Lens:

- Higher resolutions (Image densities) need to be used because beam is so small requiring more time to process
- Does not work well on fiber able plastics
- Poor focal range tolerance (Very High Divergence)
- Higher cost lens kit

### Examples:

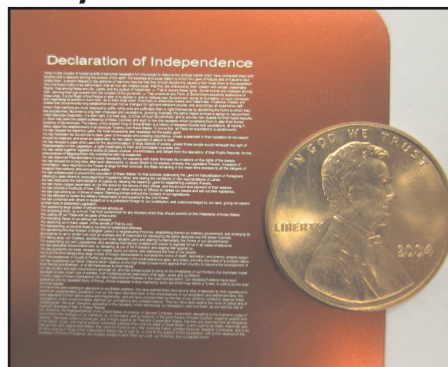

*Extreme Detail (Red Anodized Aluminum)*



*Metal Cutting (Shim Stock Steel)*



*Detailed Mark (Brass Fitting)*

## 2.0" Lens Kit 1.06 $\mu$ m FIBER

This is a Multi-Wavelength lens kit, it works with both Co2 (10.6  $\mu$ m) and Fiber (1.06 $\mu$ m) laser wavelengths. This sheet is only for the Fiber Wavelength, refer to the Co2 2.0" section when using that wavelength on the Multi-Wavelength laser system.

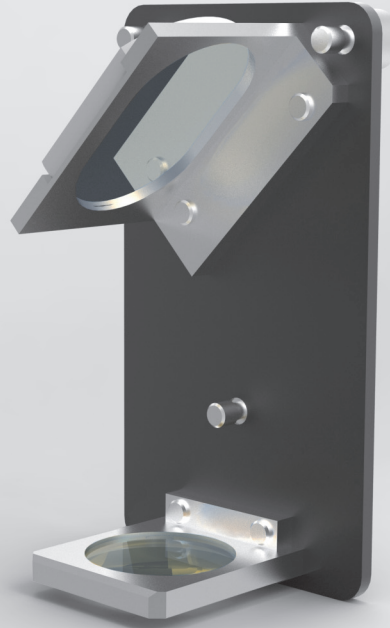
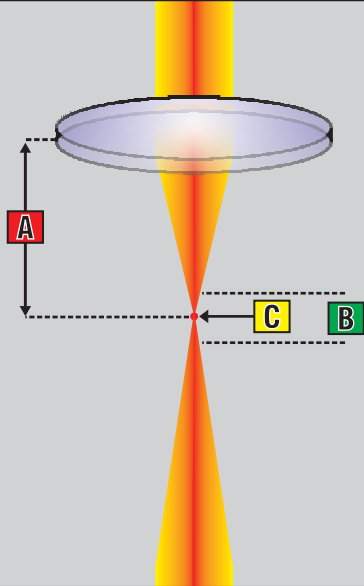

<b>A</b>		2.0" (50,8mm)
<b>B</b>	Tolerance:	+/- 0.03" (+/- 0,762mm)
<b>C</b>	Average Focus point:	0.00125" (0,032mm)

2.0" Fiber laser lens kit has been designed for very high resolution engraving and etching of extremely small fonts and photos. The 2.0" tolerance is low and cannot handle much deviation from the focus point.

### What it does:

Universal's 2.0" produces a very small beam "spot" designed for incredible detail smaller than the human eye can see on some materials. This lens kit can also be used for direct penetration marks into all metals and well as thin metal cutting on some metals. Because of the spot is so small it can have difficult achieving color change on fiber-able plastics and it has a limited focal range tolerance.

### Benefits of the 2.0 inch Fiber Lens:

- High resolutions for detailed laser processing
- Good for cutting thin, soft metals
- Can be interchanged with other lenses as needed
- Field up-gradable on PLS6MW and XLS 10MWH

### Limitations of the 2.0 inch Fiber Lens:

- Does not work well on fiber-able plastics
- Limited focal range tolerance

### Examples:



Marking (Raw Aluminum, Black & White)

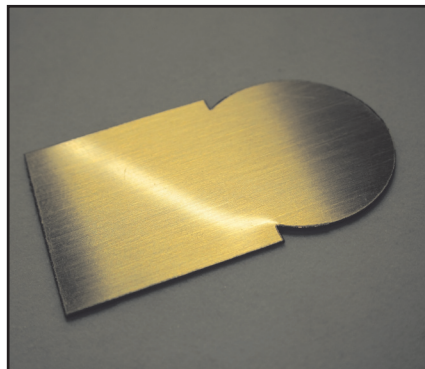

Thin Cutting (Brass, 0.020" or 0,508mm)



Depth Metal Marking (Steel)

## 4.0" Lens Kit 1.06 $\mu$ m FIBER

This is a Multi-Wavelength lens kit, it works with both Co2 (10.6  $\mu$ m) and Fiber (1.06 $\mu$ m) laser wavelengths. This sheet is only for the Fiber Wavelength, refer to the Co2 4.0" section when using that wavelength on the Multi-Wavelength laser system.

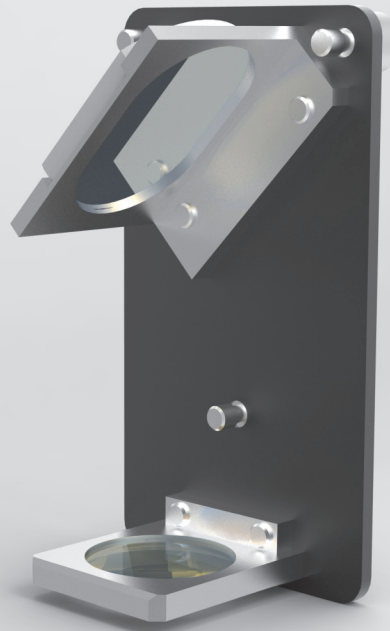
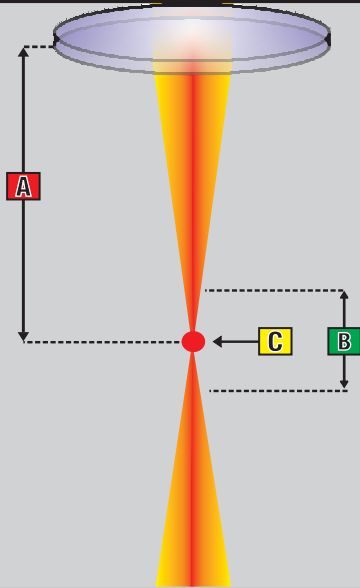

<b>A</b>	Average Focal Length:	4.0" (101,6mm)
<b>B</b>	Tolerance:	+/- 0.08" (+/- 2,032mm)
<b>C</b>	Average Focus point:	0.004"(0,102mm)

**4.0" Lens kit:** The 4.0" inch lens provides amazing detail, it has a very long focal length in addition to a small spot size. This is the most general lens kit when using the fiber wavelength and the "STANDARD" lens for the fiber laser. Can also be interchanged with any other lens.

### What it does:

This lens will produce high-quality engraving and marking. Works very well marking on all metals and is the best lens to use on fiber-able plastics. This lens produces a focused beam over a longer vertical distance while giving a very small spot size or focal point which makes it ideal when tolerance is needed when engraving within a recessed area of a product, such as inside a bowl or box. If there is a question on what lens to use with a fiber laser this will be the best choice. Because this lens is much further from the surface of the material it reduces the chance the lens will become contaminated with residue.

### Benefits of the 4.0 inch Fiber Lens:

- The all-purpose fiber laser lens
- Long focal length with small spot
- When clearance and tolerance exceeds all other lenses
- Furthest from surface of material reducing contamination
- Can be interchanged with other lenses as needed

### Limitations of the 4.0 inch Fiber Lens:

- Not the best lens for very high resolution details
- Reduces your Z axis (table height) by 2" (25,4mm)

### Examples:

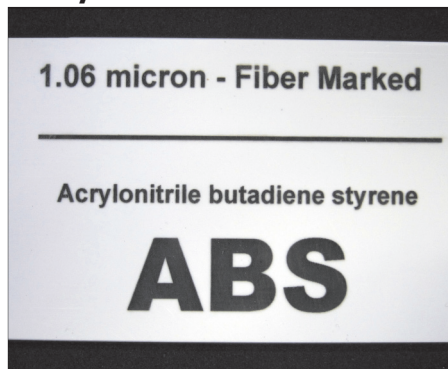

Plastic Marking (White ABS)



Direct Metal Marking (Stainless Steel)



Imagery, Plastic Marking (Black Delrin)

## Focus Tool Calibration

If a lens is out of calibration you will have difficulty producing blurry low resolution images and possible flares may result when cutting some materials. This can easily be solved by calibrating your focus tool, your focus tool is used for manual focus onto materials as well as calibrating your Auto Z feature in the driver software. Each lens has a factory calibrated focus tool that comes with that lens, if lenses are replaced or if the focus tool is dropped they may need to be re-calibrated to maintain the quality. **The following instructions provide how to calibrate your focus tool so to get the best results from a laser lens.**

1) Remove the cutting table, or rotary, or any other accessory from inside the system that blocks the motion of the stage (main engraving table) of the laser system. This may require that the laser system is turned on to enable the stage to be moved. You may also measure your focus tool shown in **figure 2** and compare your number to the chart in **figure 1** to see if your tool is close. Note that every focus tool is different it may not be the same as this chart in **figure 1**, just an average to get you close.

2) If you have no focus method raise the stage to the distance that is on the chart in **figure 1**, or use your focus tool to get as close to focus as possible onto a piece of black anodized aluminum that you place in the middle of the stage.

3) Send a small rectangle from your drawing software to the laser system as a black raster file and arrange it to engrave on the anodized aluminum in the middle of the stage.

4) Run the file using anodized aluminum settings, begin pausing the file and raising and or lowering the stage using the up and down Z buttons on the laser system control panel, continue to do this until the aluminum starts to be marked. If the stage has to be raised to start marking the aluminum, the stage is too low. If the stage has to be lowered to mark the aluminum the stage is too high.

5) Multiple attempts may be needed to get a good mark on the anodized aluminum, this is done by continuing to run the file and move the aluminum a new area of the aluminum to be marked and manually lowering the laser power will provide a more accurate calibration.

6) Adjust the Z height until the engraving is clean and sharp and the flash from the laser working appears the brightest at the lowest possible laser power. Laser response on the material will vary depending on laser wattage used, testing will be required to find the lowest settings, to start use 10% power and adjust the power and speed as needed.

7) Place the focus tool under the carriage on the front shown in **figure 3** loosen the set screw shown on **figure 1** and adjust the focus tool height to match the carriage height from the stage by sliding the shaft up or down. Lock the tool in place by tightening the set screw. The focus tool is now calibrated to the engraver's optics lens.

Repeat this process for each lens kit.

If you have any questions on this or need help please contact:  
**North America (Factory):** [support@ulsinc.com](mailto:support@ulsinc.com) or 480-609-0297  
**Europe (Africa)** +43 1-402-22-50  
**Japan (Asia)** +81 45-224-2279

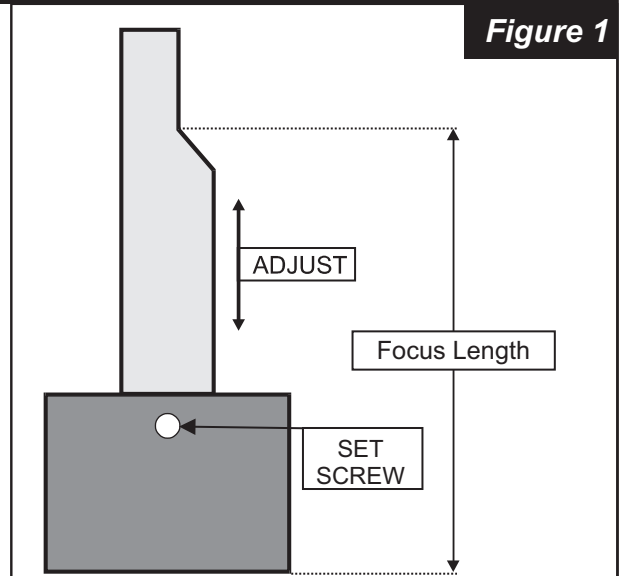

LENS	Average Focus tool distance
HPDFO	1.912 inches (48,56 mm)
1.5	1.455 inches (36,97 mm)
2.0	2.029 inches (51,56 mm)
2.5	2.505 inches (63,65 mm)
3.0	3.210 inches (81,534 mm)
4.0	4.210 inches (106,98 mm)

