



b68
AIRLOCK



User Manual

bernette

SWISS DESIGN

Table of Contents

1	IMPORTANT SAFETY INSTRUCTIONS	6	Changing the Needle	30
	Important Information	9	Positioning the Needles Up/Down	31
2	My bernette	11	Threading the Needle Manually	32
2.1	Machine Overview	11	3.9 Sewing Assistance	33
	Overview - Front	11	Using the Thread Cutter	33
	Overview - Needle Area	12	Needle Pad	33
	Overview - Presser Foot	13	Attaching/Removing the Knee Lifter	34
	Overview - Looper Area	14	Attaching/Removing the Cut-offs Bin	34
	Overview - Threading Area	15	Attaching/Removing the Freearm Cover	35
	Overview - Side Panel	16	Attaching/Removing the Slide-on Table	35
	Symbols on the Machine	17	Attaching the Decorative Threads Guide	36
	Default Values	18	4 Sewing Start	37
2.2	Overview - Standard Accessories	19	4.1 Check before Starting to Sew	37
	Included Accessories	19	4.2 Selecting the Fabric	37
	Accessories behind the Threader Cover	20	4.3 Selecting the Thread	37
	Accessories Box	21	Needle Thread	38
			Looper Thread	38
3	Setting Up the Machine	22	4.4 Selecting the Needle	39
3.1	Working Area	22	Detect Defective Needles	39
3.2	Connection and Switching On	22	Needle Overview	40
	Connecting the Machine and Foot Control	22	4.5 Fixing Fabric Layers	40
	Switching the Machine and Sewing Light On/Off	22	5 Selecting a Stitch	41
3.3	Foot Control	23	5.1 Stitch Type	41
	Press the Foot Control	23	Overlock Stitch	41
3.4	Handwheel	23	Coverstitch	45
3.5	Machine Covers	23	Chainstitch	46
	Open/Close the Threader Cover	24	Combostitch	47
	Removing/Attaching the Knife Cover Insert/Coverstitch Insert	24	5.2 Stitch Chart	49
	Removing/attaching the Coverstitch Insert for the Slide-on Table	25	6 Machine Settings	53
3.6	Spool Holder	26	6.1 Preparing the Machine for Overlock or Overlock/Chainstitch Combo	53
	Attaching the Spool Holder	26	6.2 Preparing the Machine for Cover- and Chainstitch	53
	Preparing the Thread Guide	27	6.3 Setting the Knife	53
	Attaching the Spool Stabilizer	27	Knife «On/Off»	53
	Place the Spool Disc	28	Setting the Cutting Width	54
	Using the Spool Net	28	Adjusting the Stitch Width	55
3.7	Presser Foot	28	6.4 Setting the Upper Looper On/Off	56
	Positioning the Presser Foot Up/Down	28	6.5 Upper Looper Converter Hooked in/Hooked out	57
	Lifting the Presser Foot Up/Down with the Knee Lifter	29	6.6 Setting the Stitch Length	57
	Changing the Presser Foot	29	6.7 Rolled Hem Selection Lever «N/R»	58
3.8	Needle Area	30		
	Needle Holder	30		

Table of Contents

Setting Overlocking «N»	58	2-Thread Overlock Narrow (RN)	84
Setting Rolled Hem «R»	58	2-Thread Chainstitch	84
6.8 Setting the mtc micro thread control	59	3-Thread Overlock (LN) + Chainstitch (RC)	85
6.9 Setting the Presser Foot Pressure	60	3-Thread Overlock (RN) + Chainstitch (RC)	85
6.10 Adjusting the Differential Feed	61	2-Thread Overlock (LN) + Chainstitch (RC)	86
Default Value "1"	61	2-Thread Overlock (RN) + Chainstitch (RC)	87
Gathering/Gather to fit "1.5 – 2"	62	4-Thread Coverstitch	88
Stretching "0.6"	63	3-Thread Coverstitch Wide (LC-RC)	88
7 Threading	64	3-Thread Coverstitch Narrow (LC-CC)	88
7.1 Preparing for Threading	65	3-Thread Coverstitch Narrow (CC-RC)	89
7.2 Threading the Needle Thread	66	3-Thread Picotstitch	89
Threading the Left Overlock Needle Thread LN/Yellow ..	66	9 Practical Overlocking	91
Threading the Right Overlock Needle Thread RN/Green ..	67	9.1 Securing Overlock Stitches	91
Threading the Left Coverstitch Needle Thread LC/	68	Sewing in the Overlock Chain at the Start of the Seam	91
Yellow	68	Sewing in the Overlock Chain at the End of the Seam	91
Threading the Center Coverstitch Needle Thread CC/	69	Securing Overlock Stitches	92
Green	69	Knotting the Overlock chain	92
Threading the Right Coverstitch Needle Thread RC/	70	9.2 Removing a Stitch	92
Blue	70	9.3 Securing Coverstitches	93
7.3 Threading the Looper Thread	71	Securing Cover- and Chainstitches at the Start of the	93
Using the Air Threader	71	Seam	93
Threading the Looper Thread with an Auxiliary Thread	73	Securing Cover- and Chainstitches at the Seam End ...	93
Using the Threading Wire	73	Securing the Stitches at the Seam End and Detaching	94
7.4 Changing the Thread	74	the Thread Chain	94
Knotting Thick Thread	74	9.4 How to Undo Coverstitches	95
Changing the Needle Thread	74	Undoing Coverstitches	95
Changing the Looper Thread	75	Undoing Chainstitches	95
8 Sewing Test	76	9.5 Sewing a Hem	95
8.1 Performing a Sewing Test for an Overlock Stitch	76	9.6 Flatlock	96
8.2 Performing a Sewing Test for an Coverstitch	76	9.7 Joining Seams	97
8.3 Performing a Sewing Test for an Chainstitch	76	9.8 Binding Seams	97
8.4 Optimizing Stitches	77	9.9 Topstitching Seams	98
4-Thread Overlock with Integrated Safety Seam	77	9.10 Gathering	98
3-Thread Super Stretch	77	Pulling the Needle Thread	98
3-Thread Overlock Wide (LN)	78	9.11 Gathering a Seam	99
3-Thread Overlock Narrow (RN)	78	9.12 Sew Outer Corners	99
3-Thread Flatlock Wide (LN)	79	9.13 Sewing Inner Corners	100
3-Thread Flatlock Narrow (RN)	79	9.14 Sewing Inner Curves	100
3-Thread Narrow Seam	80	9.15 Sew Outer Curves and Circles	101
3-Thread Rolled Hem	80	10 Appendix	102
2-Thread Wrapped Overlock Wide (LN)	81	10.1 Storing and Transporting the Machine	102
2-Thread Wrapped Overlock Narrow (RN)	82	Storing the Machine	102
2-Thread Flatlock Wide (LN)	82	Transporting the Machine	102
2-Thread Flatlock Narrow (RN)	83	10.2 Maintenance and Cleaning the Machine	102
2-Thread Rolled Hem	83		
2-Thread Overlock Wide (LN)	83		

Cleaning the Machine	102
Cleaning the Looper Area	103
Cleaning the Air Threader Pipes	104
Cleaning the Suction Feet	104
Oiling the Machine	104
10.3 Troubleshooting	105
10.4 Technical Specifications	106

IMPORTANT SAFETY INSTRUCTIONS

Please be aware of the following basic safety instructions when using your machine. Before using this machine, read instruction manual carefully.

DANGER

To protect against electric shock, the following instructions must be observed.

- Never leave the machine unattended when it is connected to the power supply.
- Immediately after use and before cleaning, switch off the machine and disconnect the power cable from the outlet.

In order to protect against injury, the following instructions must be adhered to.

- Do not look directly into the LED lamp with optical instruments (e. g. magnifying glass).
- If the LED lamp is damaged or defective, have the LED lamp checked or repaired at your local authorized bernette dealer.
- Switch off the machine before working in the needle area.
- Before starting the machine, attach all protection guards and close the covers.

WARNING

To reduce the risk of burns, fire, electric shock or injury to persons, the following instructions must be observed.

General Facts

- This machine may only be used for the purpose described in this instruction manual.

Working Environment

- Do not use the machine outdoors.
- Only use the machine in dry rooms.
- Do not use the machine in a humid area.
- Do not use the machine in rooms where aerosol products (sprays) are being used.
- Do not use the machine in rooms where oxygen is dispensed.

Technical Condition

- Never use the machine when it is damp.

- Do not use the machine if it is not working properly.
- Do not use the machine if a cable or the plug is damaged.
- Do not use the machine if it has been dropped, damaged or has fallen into water.
- If the machine is damaged or does not work properly, have the machine checked or repaired by your local authorized bernette dealer.
- Keep all ventilation openings of the machine and the foot control free of lint, dust and loose cloth.
- Do not use the machine if the ventilation openings are blocked.

Accessories and Supplies

- Only use the accessories recommended by the manufacturer.
- Always use the original bernette Stitch Plate.
An incorrect stitch plate can result in needle breakage.
- Use only straight needles of good quality.
Bent or damaged needles can cause needle breakage.
- This machine is double-insulated (except for USA, Canada and Japan).
Use only identical replacement parts. See instructions for Servicing of double-insulated products.
- To lubricate the machine, only use the supplied overlocker oil.

Safety Instructions

- While operating the machine, all protective inserts must be in place and all covers must be closed.

Appropriate Use

- The machine may be used, cleaned and maintained by children older than eight or by people with reduced physical, sensory or mental capabilities or if there is a lack of experience and knowledge as long as they have been given instructions.
- Furthermore, these persons must be supervised while working with the machine, and/or they must know the safe operation of the machine and be aware of the resulting hazards.
- Children are not allowed to play with the system.
- Special care should be taken when the machine is operated by or in the presence of children.
- Only use the machine with the supplied power cable.
- USA and Canada only: Do not connect power plug NEMA 1-15 to circuits exceeding 150 volt-to-ground.

- Only use this machine with the supplied foot control of type 4C-326G/4C-316B.
- Do not insert any objects into the openings of the machine.
- Do not place any objects on the foot control.
- While sewing, guide the fabric gently.
Pulling and pushing the fabric can cause needle breakage.
- Keep fingers away from all moving parts.
- Special care is required in the needle area, the loopers and the knife.
- For activities in the needle area - such as threading the needle, changing the needle, threading the looper or changing the presser foot - switch off the machine.
- To switch off, set the power switch to «0».
- When protective covers are removed, when the machine is oiled or when other cleaning and maintenance operations mentioned in this instruction manual are carried out, switch off the machine and disconnect the power plug from the outlet.
- Pull the plug out of the outlet by pulling on the plug. Do not pull on the cable.

Important Information

Availability of the Instruction Manual

The short manual is part of the machine.

- Keep the short manual of the machine in a suitable place near the machine and have it ready for reference.
- The latest version of the detailed instruction manual can be downloaded at www.bernette.com.
- When passing on the machine to a third party, enclose the short manual of the machine.

Proper Use

Your bernette machine is conceived and designed for private household use. It answers the purpose for overlocking fabrics as it is described in this instruction manual. Any other use is not considered proper. BERNINA assumes no liability for consequences resulting from improper use.

Equipment and Scope of Delivery

Example images are used in these instructions for the purposes of illustration. The machines shown in the images and the accessories shown therefore do not always match the actual items included with your machine. The supplied accessory can vary depending on the country of delivery. You can acquire any accessories mentioned or shown that are not included in the scope of delivery as optional accessories from a specialist bernette dealer. Further accessories can be found at www.bernette.com.

For technical reasons and in order to improve the product, changes may be made to the equipment of the machine and the scope of delivery at any time and without prior notice.

Servicing of Double-insulated Products

In a double-insulated product two systems of insulation are provided instead of grounding. No grounding means is provided on a double-insulated product nor should a means for grounded be added to the product. Servicing a double-insulated product requires extreme care and knowledge of the system and should only be done by qualified service personnel. Replacement parts for a double-insulated product must be identical to the original parts in the product. A double insulated product is marked with the words: «Double-Insulation» or «double-insulated».



The symbol may also be marked on the product.

Environmental Protection

BERNINA International AG is committed to environmental protection. We strive to minimize the environmental impact of our products by continuously improving product design and our technology of manufacturing.



The machine is labeled with the symbol of the crossed-out wastebasket. This means that the machine should not be disposed of in household waste when it is no longer needed. Improper disposal can result in dangerous substances getting into the groundwater and thus into our food chain, damaging our health.

The machine must be returned free of charge to a nearby collection point for waste electrical and electronic equipment or to a collection point for the reuse of the machine. Information on the collection points can be obtained from your local administration. When purchasing a new machine, the dealer is obliged to take back the old machine free of charge and dispose of it properly.

If the machine contains personal data, you are responsible for deleting the data yourself before returning the machine.

Explanation of Symbols



DANGER

Designates a danger with a high risk which can lead to serious injuries or even death unless it is avoided.



WARNING

Designates a medium-risk hazard which can lead to serious injuries if not avoided.



CAUTION

Designates a low-risk hazard which can lead to minor or moderate injuries if not avoided.

NOTICE

Designates a hazard which can lead to material damage if not avoided.

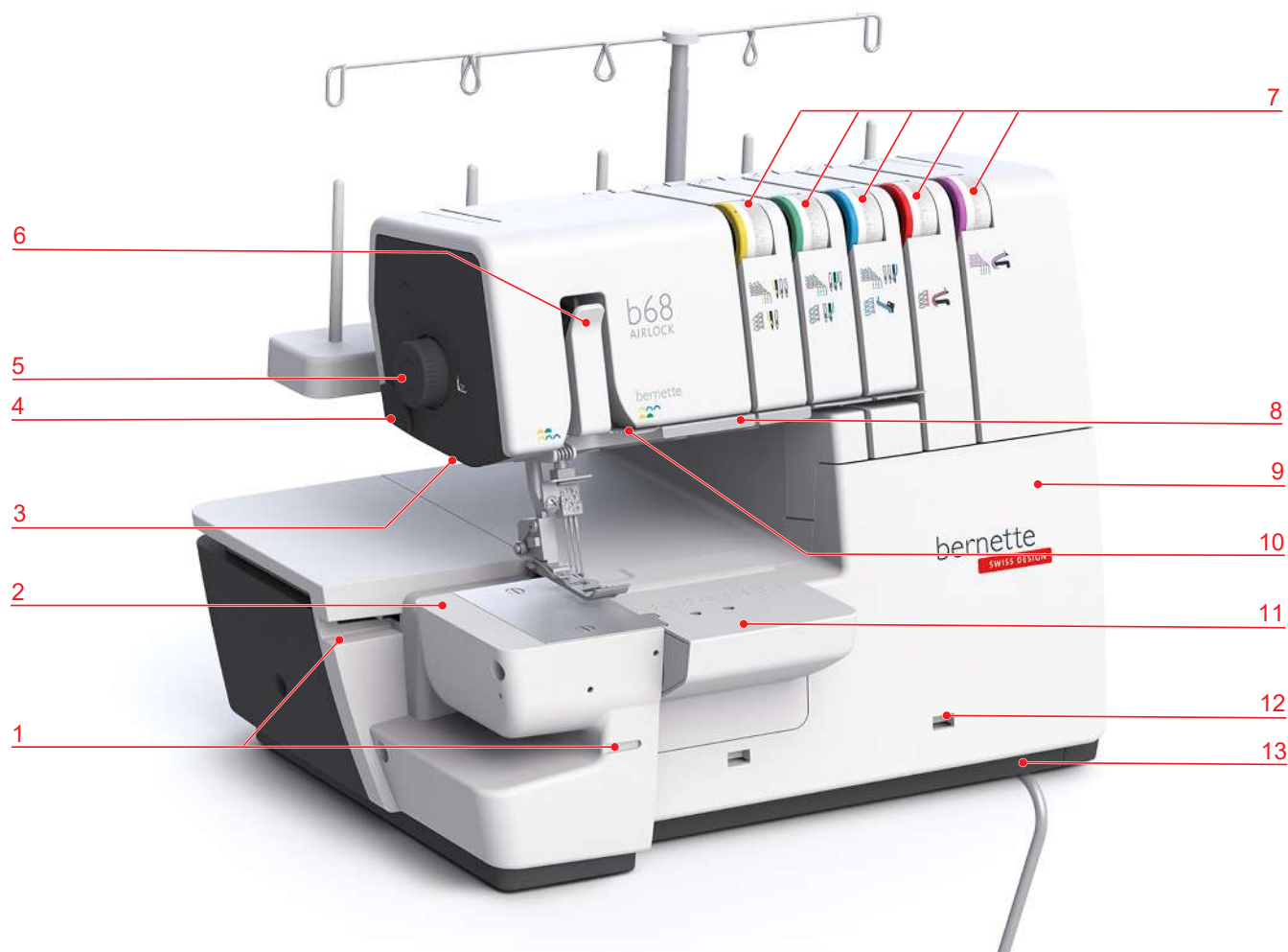


You will find **tips** from bernette **sewing experts** next to this symbol.

2 My bernette

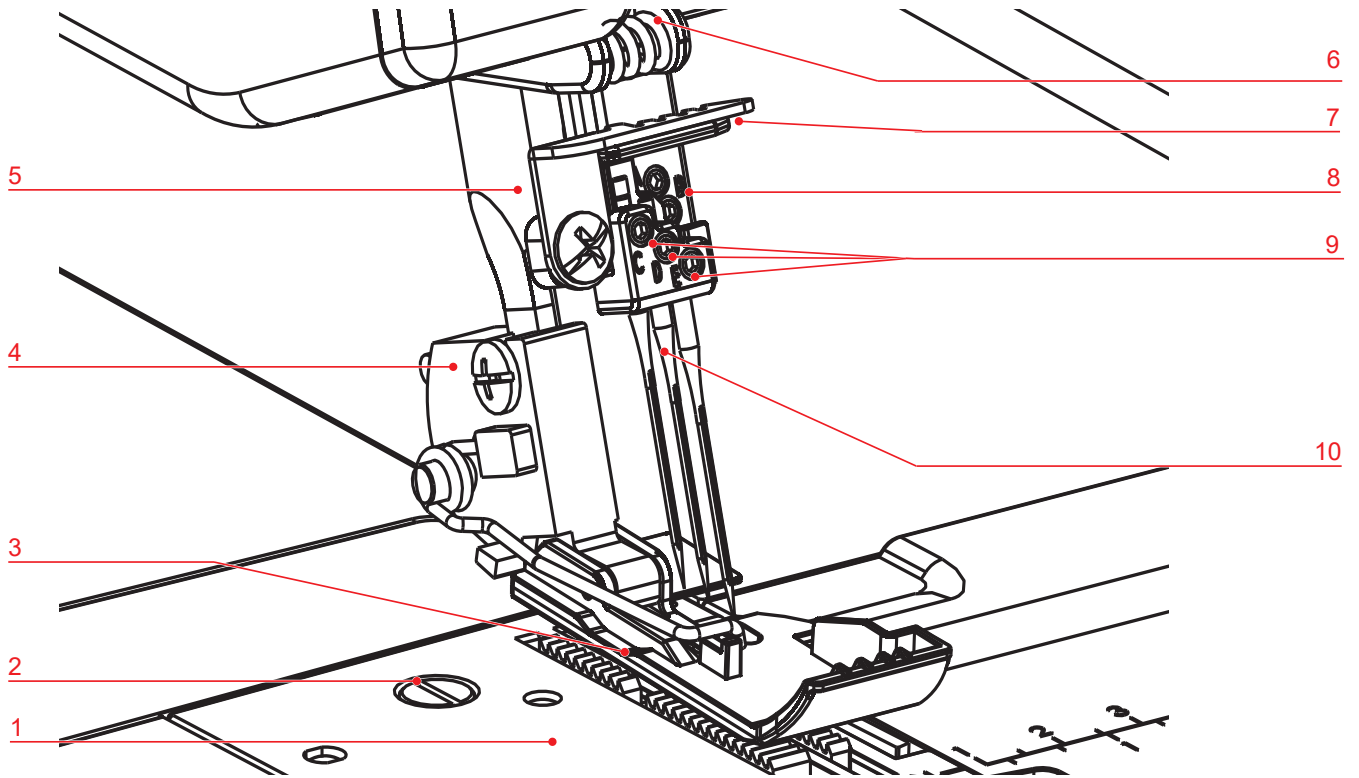
2.1 Machine Overview

Overview - Front



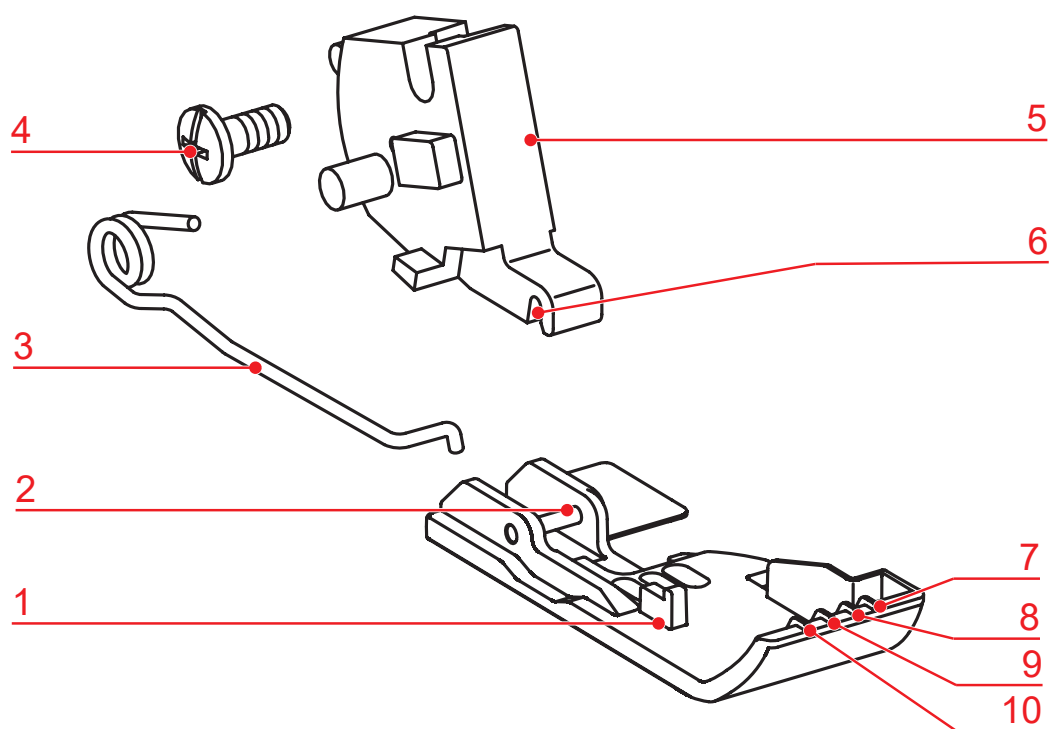
- | | | | |
|---|-----------------------------------|----|----------------------------------|
| 1 | Guide Rail | 8 | Thread Guide Plate |
| 2 | Freearm | 9 | Threader Cover |
| 3 | Sewing Light | 10 | Thread Deflection Fingers |
| 4 | Thread Cutter | 11 | Coverstitch Insert |
| 5 | Presser Foot Pressure Wheel | 12 | Cut-offs Bin Snap-in Opening |
| 6 | Needle Thread Take-up Lever Cover | 13 | Connection for Knee Lifter (FHS) |
| 7 | Thread Tension Adjustment | | |

Overview - Needle Area



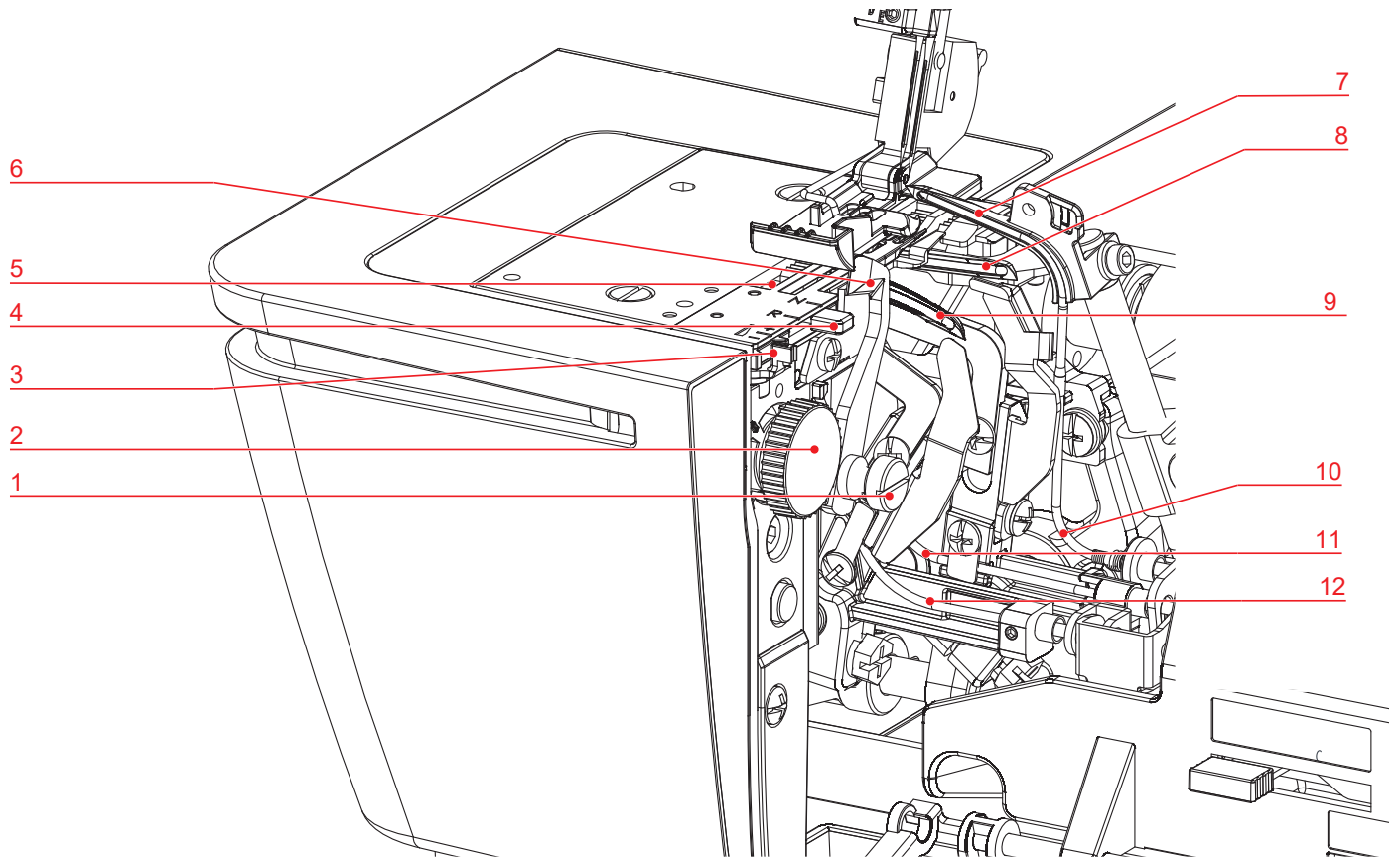
- | | | | |
|---|-----------------------------|----|-----------------------------------|
| 1 | Stitch Plate | 6 | Thread Guide on the Machine |
| 2 | Stitch Plate Screw | 7 | Thread Guide on the Needle Holder |
| 3 | Standard Presser Foot | 8 | Needle Holder |
| 4 | Presser Foot Release Button | 9 | Needle Screws |
| 5 | Presser Foot Bar | 10 | Needles |

Overview - Presser Foot



- | | | | |
|---|-----------------------|----|---|
| 1 | Presser Foot Sole | 6 | Shaft Groove |
| 2 | Presser Foot Sole Pin | 7 | Marking: Right Overlock Needle (RN) |
| 3 | Presser Foot Spring | 8 | Marking: Right Coverstitch Needle (RC) |
| 4 | Fixing Screw | 9 | Marking: Center Coverstitch Needle (CC) |
| 5 | Presser Foot Shaft | 10 | Marking: Left Coverstitch Needle (LC) |

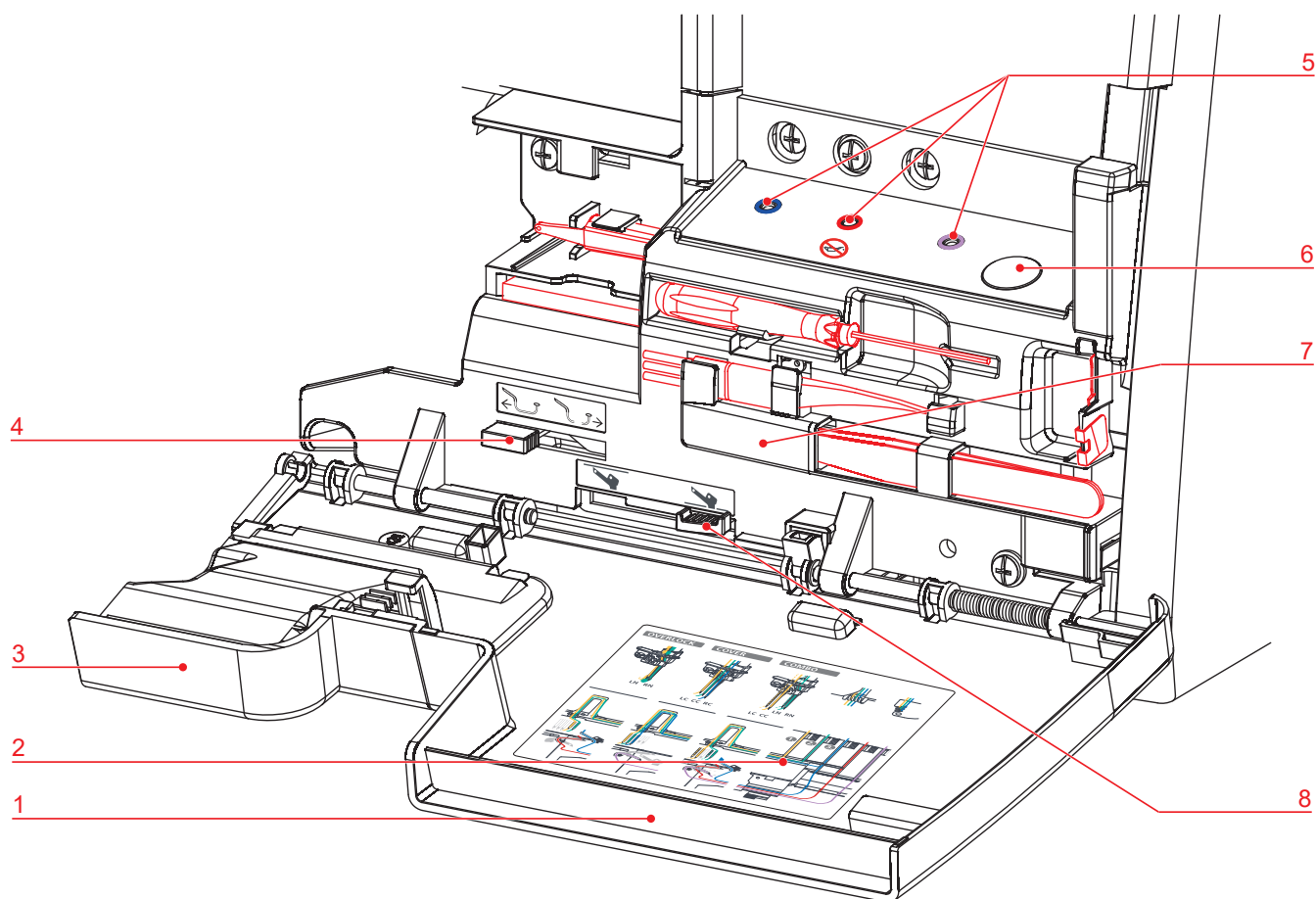
Overview - Looper Area



- 1 Knife On/Off
- 2 Cutting Width Dial
- 3 mtc micro thread control dial
- 4 Rolled Hem Selection Lever
- 5 Feed Dog
- 6 Knife

- 7 Upper Looper
- 8 Lower Looper
- 9 Chain Looper
- 10 Air Threader Pipes Upper Looper
- 11 Air Threader Pipes Lower Looper
- 12 Air Threader Pipes Chain Looper

Overview - Threading Area



- | | | | |
|---|---------------------------------------|---|---|
| 1 | Threader Cover | 5 | Air Threader Nozzles |
| 2 | Threading Chart | 6 | Air Threader Lever |
| 3 | Knife Cover Insert/Coverstitch Insert | 7 | Accessories Stored in the Needle Threader Cover |
| 4 | Air Threader Connector On/Off | 8 | Upper Loper On/Off |

Overview - Side Panel















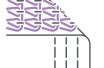














- | | | | |
|---|--------------------------|----|--------------------------------|
| 1 | Carry Handle | 7 | Stitch Length Setting |
| 2 | Retractable Thread Guide | 8 | Differential Feed Dial |
| 3 | Spool Pin | 9 | Handwheel |
| 4 | Spool Holder | 10 | Air Vents |
| 5 | Needle Pad | 11 | Foot Control-/Power Connection |
| 6 | Presser Foot Lifter | 12 | Main Switch |

Symbols on the Machine

The symbols on the machine are for your guidance and give assistance when adjusting settings and threading the machine.

- Overlock Stitch Formation «OL»
- Coverstitch Formation «CS»
- Chainstitch Formation «CS»

	LN (Left Overlock Needle)	Left Overlock Needle Thread
		Thread Path Yellow «OL»
	LC (Left Cover Needle)	Left Coverstitch Needle Thread
		Thread Path Yellow «CS»
	RN (Right Overlock Needle)	Right Overlock Needle Thread
		Thread Path Green «OL»
	CC (Center Cover Needle)	Center Coverstitch Needle Thread
		Thread Path Green «CS»
	RC (Right Cover Needle)	Right Coverstitch Needle Thread
		Thread Path Blue «CS»
	UL (Upper Looper)	Upper Looper Thread
		Thread Path Blue
	LL (Lower Looper)	Lower Looper Thread
		Thread Path Red
	CL (Chain Looper)	Chain Looper Thread
		Thread Path Purple «CL»

	ULC (Upper Looper Converter)	Upper Looper Cover
		Upper Looper On/Off
	CW (Cutting Width)	Cutting Width
	SL (Stitch Length)	Stitch Length
	DF (Differential Feed)	Differential Feed
	N/R	Rolled Hem Selection Lever
	mtc	mtc micro thread control
	FHS (Free Hand System)	Knee Lifter (Free Hand System)
		Foot Pressure
		Air Threader
		Air Threader Connector On/Off

Default Values

The default values of the machine are chosen so that the settings are suitable for most typical applications.

- 4** ● The default values are marked on the machine with a dot.

The actual values may differ from the stitch chart depending on the fabric, thread and stitch and may need to be adjusted to the result of the sewing sample.

2.2 Overview - Standard Accessories

Included Accessories

To find more accessories, visit www.bernette.com.







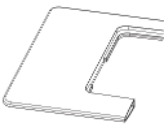

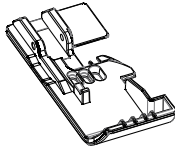
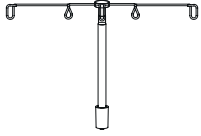
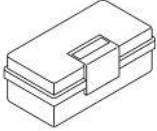


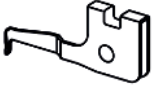


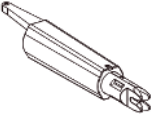
Figure	Name	Purpose
	Foot Control with Power Cable	To connect the machine with the power supply system. To start and stop the machine. To control the sewing speed.
	Cut-Offs Bin	To collect scraps and fabric trimmings.
	Knife Cover Insert	To protect the fingers and to deflect the fabric cut-offs during the sewing process.
	Coverstitch Insert	To protect the fingers and the looper area.
	Coverstitch Insert for Slide-on Table	To protect the fingers and the looper area. To increase the sewing area when using the slide-on table.
	Freearm Cover	To extend the work surface.
	Slide-on Table	To increase the sewing surface.
	Free Hand System (FHS)	To raise and lower the presser foot.
	Standard Presser Foot	For all overlock, cover and combostitches. For general sewing projects.



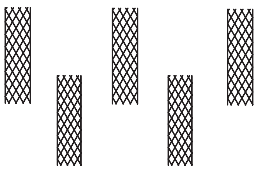
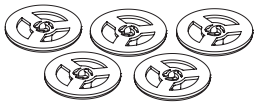



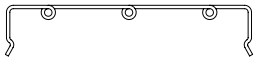
Figure	Name	Purpose
	Retractable Thread Guide	For an even unwinding of the thread from the thread cones.
	Accessories Box	To store the supplied accessories as well as optional accessories.

Accessories behind the Threader Cover

The most often used accessories while sewing are stored behind the threader cover on the machine, so it is always quickly at hand.

Figure	Name	Purpose
	Needle Set ELx705 CF	Recommended needles for all-purpose use.
	Screwdriver	To loosen or tighten the fixing screws on the needle holder.
	Upper Looper Cover	To cover the upper looper. For sewing 2-thread overlock and the 3-thread super stretch stitch.
	Brush	To clean the feed dog and the looper area.
	Tweezers	For gripping the thread in tight positions.
	Needle Threader/ Inserter	To manually thread, insert and remove the needle.

Accessories Box

Figure	Name	Purpose
	Overlocker Oil	For oiling the looper components.
	Spool Stabilizer (5 x)	To stabilize the thread cone on the spool holder.
	Spool Net (5 x)	To support even unwinding of nylon, rayon, silk or metallic threads from the spool.
	Spool Cap (5 x)	To support the regular unwinding of the thread from the spool.
	Screwdriver	To loosen/tighten the stitch plate screws.
	CS Lock Tool	To pull the needle threads and to secure the stitches. To separate the threads so that the sewing project can be removed from or placed under the presser foot.
	Threading Wire	To thread the looper threads manually in the air threader pipe.
	Decorative Thread Guide	To sew with decorative threads for particularly wide and long stitches, for seams and edge finishing.

3 Setting Up the Machine

3.1 Working Area

A stable table with a secure stand is a good prerequisite for optimal sewing results. Ergonomics around the sewing table is important to protect the muscles and joints of the back, shoulder, arms and hands. The recommendation for optimal ergonomics includes matching the table height with the body posture. Avoid remaining in the same position for long periods.

The machine can also be operated when standing.

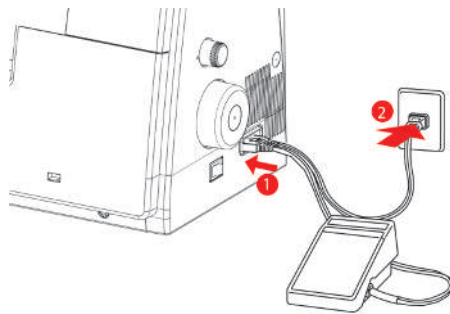
- > Place the machine on a solid table.

Correct Sitting Position

With the arms bent (90°), the fingertips can touch the stitch plate in a comfortable sitting position.

3.2 Connection and Switching On

Connecting the Machine and Foot Control

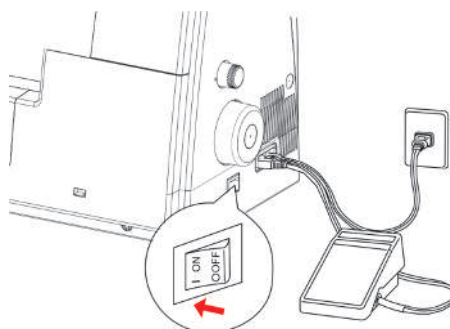


- > Insert the device plug (1) of the foot control/power cable into the connection for the foot control/power cable.
- > Insert the power plug (2) of the foot control/power cable into the socket.

Use of the Power Cable (only USA/Canada)

The machine has a polarized plug (one contact is wider than the other). To reduce the risk of electric shock, the plug can only be plugged into the socket in one way. If the plug does not fit into the socket, turn the plug. If it still does not fit, an electrician needs to be called to install an appropriate outlet. Do not modify the plug in any way.

Switching the Machine and Sewing Light On/Off



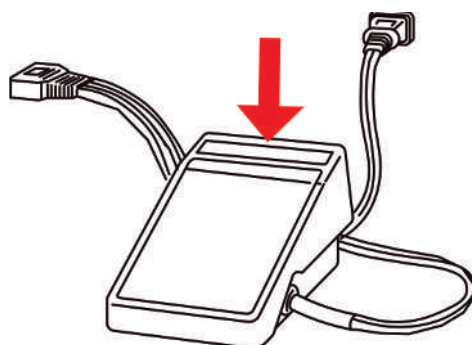
- > Set the power switch to «I».
 - The machine and the sewing light are switched on.
- > Set the power switch to «O».
 - The machine and the sewing light are switched off, whereby the sewing light may still glow a little.

3.3 Foot Control

Press the Foot Control

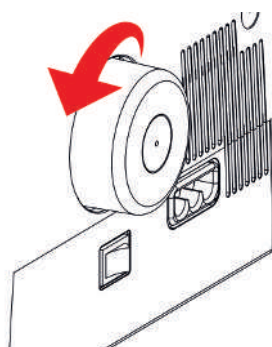
By operating the foot control the needle and knife move. The sewing speed can be infinitely adjusted by more or less pressure on the foot control.

- > To start the sewing process, increase the pressure on the foot control.
- > To stop the sewing process, reduce the pressure on the foot control.



3.4 Handwheel

By turning the handwheel counterclockwise, several activities can be performed.



- Slow, Precise Placement of the Needle
- Moving the Loopers
- Moving the Knife
- Mechanical Coupling of the Air Threader

3.5 Machine Covers

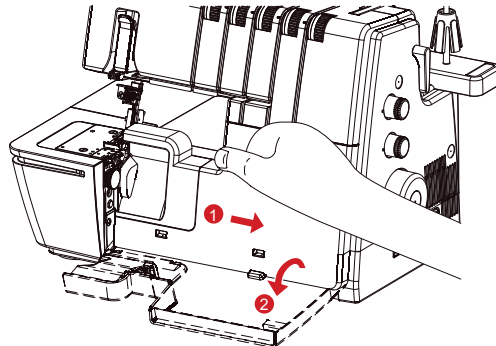
The machine covers protect against injuries caused by moving components and prevent fragile elements from being damaged. All covers must be fitted or closed prior to sewing.

- Threader Cover
- Knife Cover Insert
- Coverstitch Insert for Slide-on Table

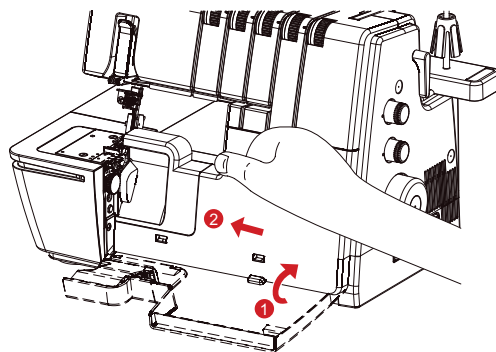
Open/Close the Threader Cover

The threader cover protects the inserted looper threads during sewing operations. The accessory holder on the inside of the threader cover provides quick access to the most frequently used accessories.

- > To open the threader cover, push it to the right and swing it forward.



- > To close the threader cover, swing the threader cover up until it clicks into place to the left.



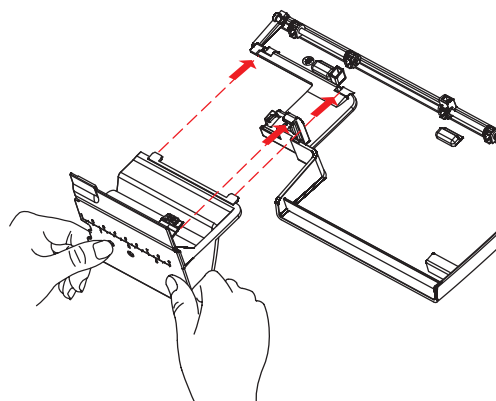
If the threader cover cannot be closed completely, the air threader connector is still switched on.

Removing/Attaching the Knife Cover Insert/Coverstitch Insert

The knife cover insert or the coverstitch insert protects against injuries caused by the knife or by the looper movement.

Prerequisite:

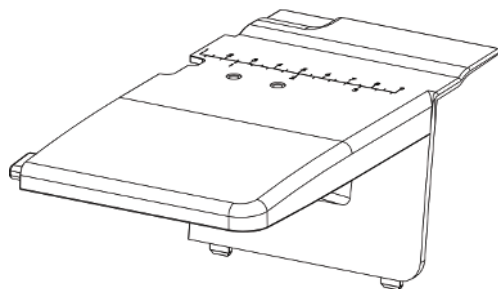
- The cuff-off bin is removed.
 - The looper cover is opened.
 - For the coverstitch insert, the knife and the upper looper are lowered.
- > To remove the knife cover insert or the coverstitch insert, press the snap-in points downwards and pull out of the snap-in opening.
 - > To insert the knife cover insert or the coverstitch insert, push the snap-in points into the snap-in opening.



NOTICE**Missing Knife Cover Insert or Coverstitch Insert while Sewing**

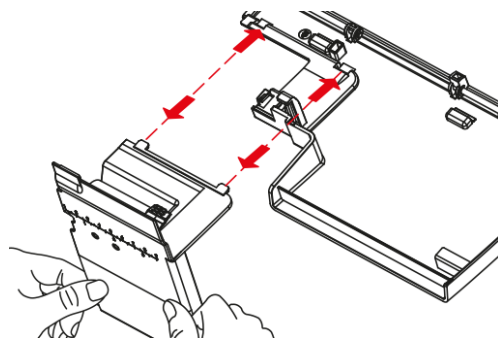
Injuries caused by the knife or by the looper movement.

Before each sewing, check whether the mounted knife cover insert or the coverstitch insert is attached.

Removing/attaching the Coverstitch Insert for the Slide-on Table

Prerequisite:

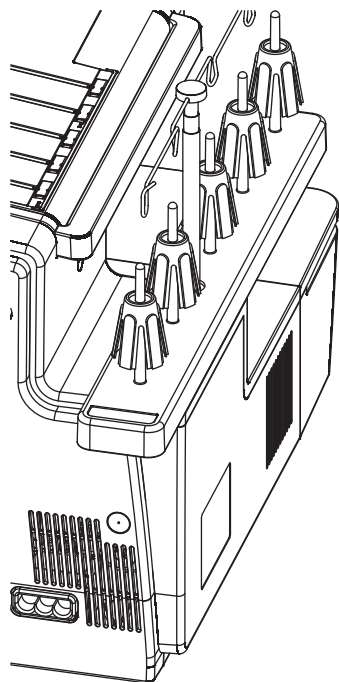
- Threader cover is opened.
- > To remove the coverstitch insert, press the snap-in points downwards and pull out of the snap-in opening.
- > To insert the coverstitch insert for the slide-on table, push the snap-in points into the snap-in opening.



- > To remove the coverstitch insert for the slide-on table, press the snap-in points downwards and pull out of the snap-in opening.

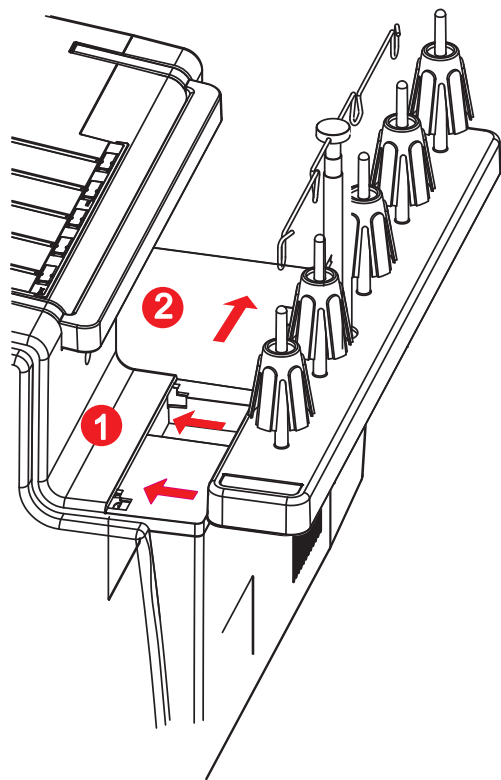
3.6 Spool Holder

Thread cones, foot spools or household spools of all sizes can be placed on the spool holder.



Attaching the Spool Holder

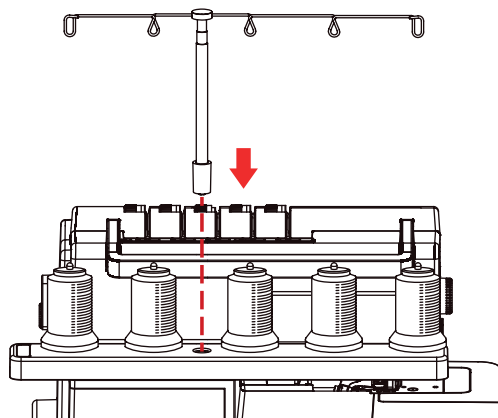
- > To fit the spool holder, press the connection points of the spool holder from the back to the front of the machine and engage them laterally.



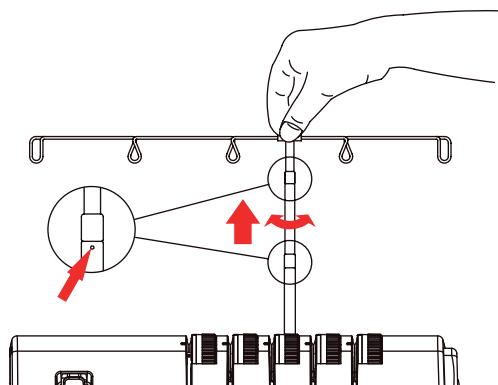
Preparing the Thread Guide

The thread guide ensures a clean unwinding of the thread from the thread cones. Each thread is guided through a thread guide wire located directly above the thread cone.

- > To attach the retractable thread guide, insert the thread guide into the provided opening in the spool holder until it clicks.



- > Hold the thread guide and pull it up to the stop.
- > Turn the thread guide to the left and right until the two positioning pins engage.
 - The outer thread guide wires are parallel to the machine front.



- > To retract the thread guide, push the thread guide down with a little pressure.

Attaching the Spool Stabilizer

For large thread cones, the spool stabilizer serves to stabilize the thread cone on the spool pin.

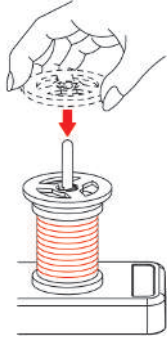


- > For extremely conical spools, place the spool stabilizer onto the thread spool pin with the pointy end up.
- > For slightly conical spools, place the spool stabilizer onto the thread spool pin with the pointy end down.

Place the Spool Disc

The spool disc ensures the stability of the thread spool and the even unwinding of the thread.

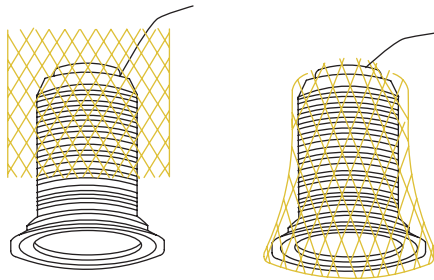
- > Place the thread spool on the spool holder.
- > Push the flat side of the spool cap over the spool pin to the thread spool.



Using the Spool Net

The spool net prevents the thread from sliding down from the thread spool and is recommended for special threads.

- Thin threads, which slide easily off the spool
 - Nylon, rayon, silk threads or effect and metallic threads
- > Put the spool net over the thread spool from above and pull the thread end upwards.

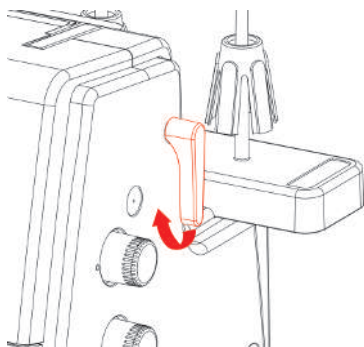


3.7 Presser Foot

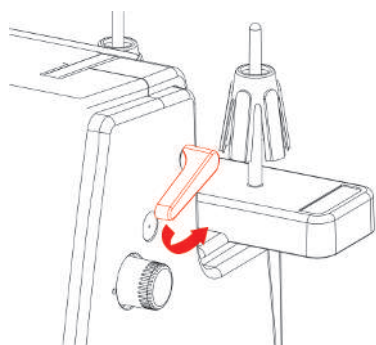
Positioning the Presser Foot Up/Down

The lifted presser foot allows you to place the sewing project under the presser foot. The lowered presser foot is a prerequisite for starting to sew.

- > Lift the presser foot lifter until it engages.
 - The presser foot remains in the upper position.
 - The thread tension is released.



- > Lower the presser foot lifter.
 - The machine is ready for sewing.
 - The thread tension is active.

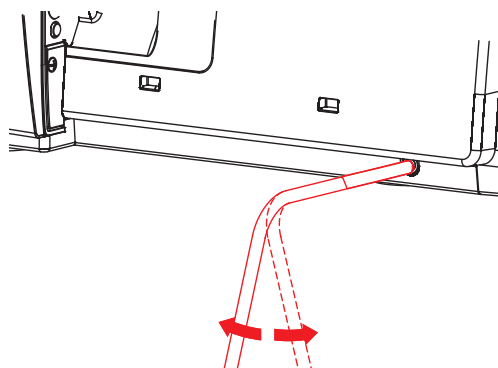


Lifting the Presser Foot Up/Down with the Knee Lifter

Temporarily lifting the presser foot using the knee lifter allows to position the sewing project with both hands.

Prerequisite:

- The knee lifter is attached.
- > To raise the presser foot, press the knee lifter with the knee out to the right and hold it in place.

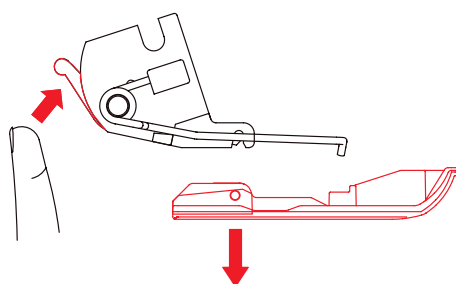


- > To lower the raised presser foot, slowly release the pressure on the knee lifter.
- > To lower the already engaged presser foot, press the knee lifter all the way to the right and release slowly.

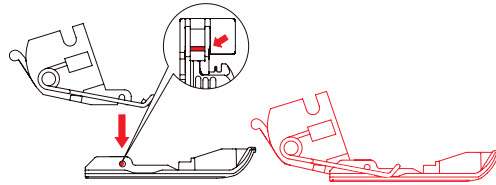
Changing the Presser Foot

Prerequisite:

- The needles are in the top position.
 - The presser foot is raised.
- > Press the release button on the rear side of the presser foot shaft.
 - The presser foot is released.



- > Lift the presser foot spring slightly and remove the presser foot.
- > Lift the presser foot spring slightly and place the new presser foot beneath the shaft groove so that the shaft groove lies exactly above the presser foot pin.
- > Lower the presser foot shaft carefully until the shaft groove engages with the presser foot pin.

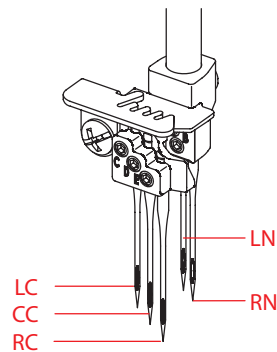


- > Raise the presser foot.

3.8 Needle Area

Needle Holder

The needle holder can hold five needles. The machine is designed for needles of the ELx705 system. Needle sizes between 80-100 (12-16) are to be used for this machine.



Needles for Coverstitches



«LC» Left coverstitch needle for coverstitches and chainstitches.

«CC» Center coverstitch needle for coverstitches and chainstitches.

«RC» Right coverstitch needle for coverstitches.

Needles for Overlock Stitches



«LN» Left needle for overlock stitches.

«RN» Right needle for overlock stitches.

Changing the Needle

The use of the needle inserter is recommended and prevents the needle from falling into the feed dog area.

Correctly inserted needles are not at the same height.

The needle holder screws must always be tightened, even if no needles are inserted. This prevents the needle holding screws from falling out because of vibrations.

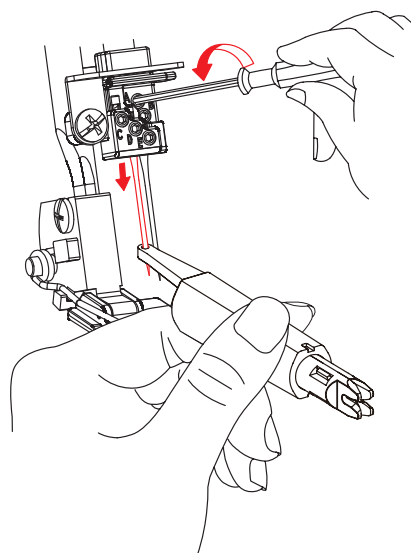
NOTICE**Damage due to Excessive Tightening of the Screws**

The threads of the needle holder may be damaged. A repair by the authorized bernette dealer is required.

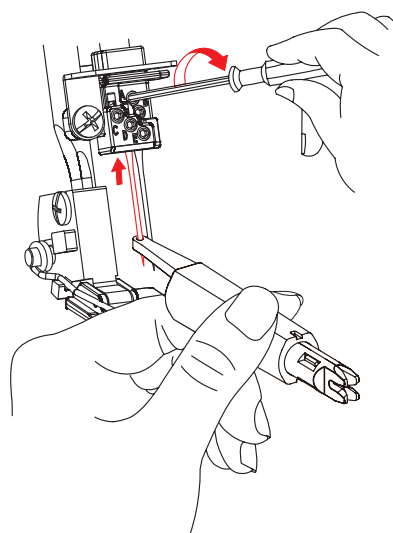
- > Do not overtighten the needle screws.

Prerequisite:

- The needles are in the top position.
 - The presser foot is raised.
- > Hold the needle and loosen the needle screw from the threader cover using the screwdriver supplied.



- > Remove the needle downwards and store it in the needle pad.
- > Insert the new needle with the flat side to the back into the needle inserter.



- > Push the needle into the corresponding needle holder opening as far as it will go.
- > Check the needle position in the needle checking window.
- > Tighten the needle screws.

Positioning the Needles Up/Down

The needle position up/down is recommended for various actions.

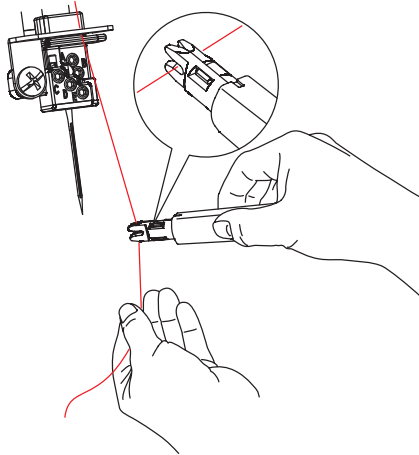
- to change the needle
- to thread the needle

- to activate the air threader pipes
 - to change the presser foot
- > To move the needle manually, turn the handwheel counter-clockwise until the desired needle position is reached.

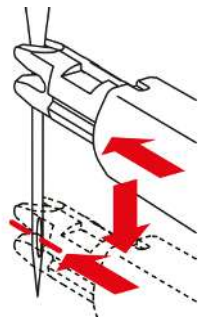
Threading the Needle Manually

With the needle threader every needle can be threaded easily.

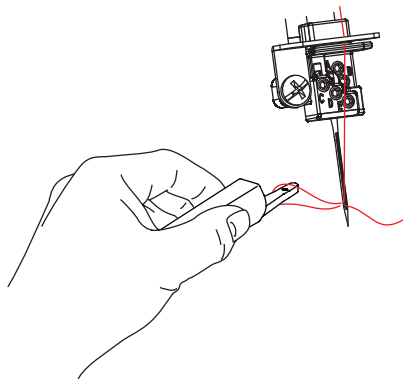
- > Hold the needle threader with the flat grip side facing up.
- > Pull the thread horizontally through the slot and hold the end of the thread.



- > Position the needle threader with the V-guide at the top of the needle and with little pressure slide along the needle to the eye.



- The metal pin presses the thread through the eye of the needle.
- > Release the pressure on the needle threader and remove it from the needle.
- A thread loop is formed.
- > Pull the thread loop with the end of the needle threader to the back.



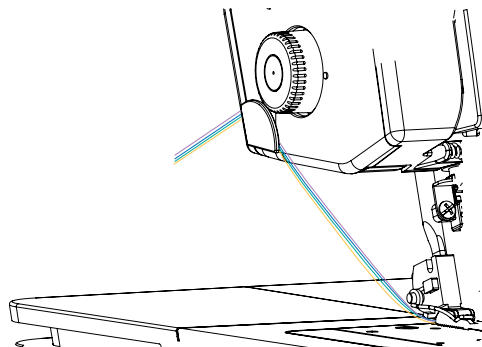
- > Place the thread under the presser foot to the back left.

3.9 Sewing Assistance

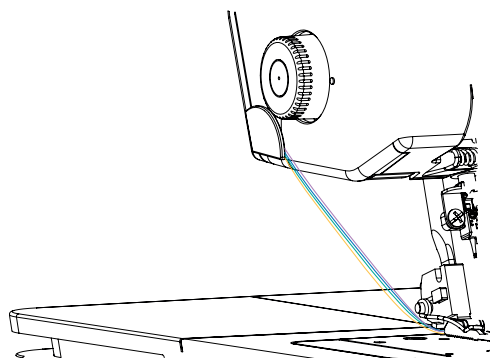
Using the Thread Cutter

The thread cutter is used to cut the threads/thread chain.

- > Pull the threads/thread chain down from the front into the thread cutter.



- The threads/thread chains are held after cutting and are ready for sewing.



Needle Pad

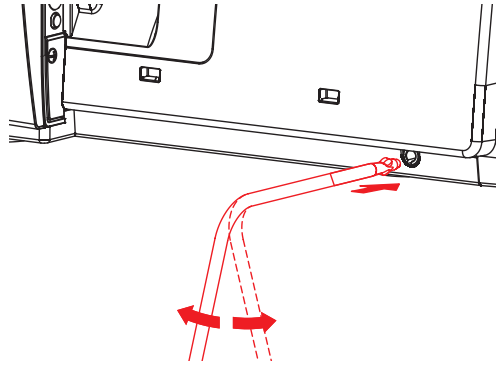
The needle pad is used to store needles that are not being used.



Attaching/Removing the Knee Lifter

Temporarily lifting the presser foot using the knee lifter allows to position the sewing project with both hands.

- > To attach the knee lifter, push the knee lifter engaging cam in a horizontal position into the knee lifter connection until it stops.



- > To remove the knee lifter, pull the knee lifter out of the knee lifter connection without swinging the knee lifter sideways.

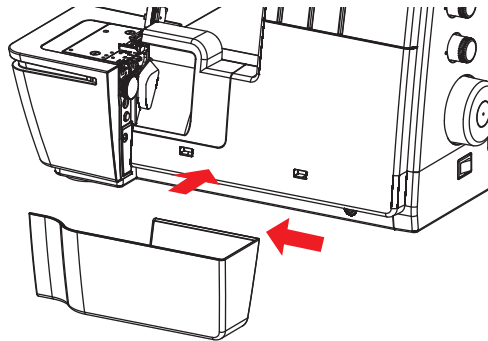


The swing-out position of the knee lifter can be adjusted at an authorized bernette dealer if required.

Attaching/Removing the Cut-offs Bin

The cut-offs bin catches the fabric scraps during the sewing process.

- > To attach the cut-offs bin, hook the cut-offs bin into the snap-in opening on the looper cover.



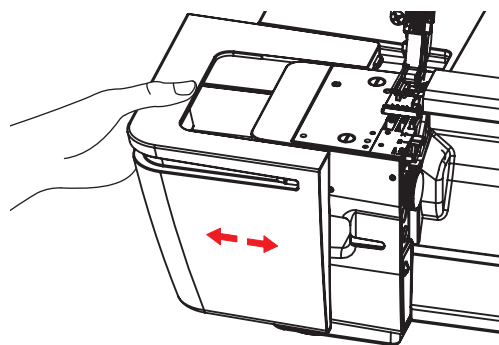
- > To remove the cut-offs bin, lift the cut-offs bin out of the snap-in opening on the looper cover.

Attaching/Removing the Freearm Cover

The freearm is ideal when working with tubular, closed projects such as cuffs, trouser hems or sleeve ends. The freearm cover closes the gap between the stitch plate and the sewing surface.

Prerequisite:

- The slide-on table is removed.
- > To attach the freearm cover, push the freearm cover along the guide rails from the left until it engages.
- > To remove the freearm cover, pull the freearm cover to the left.

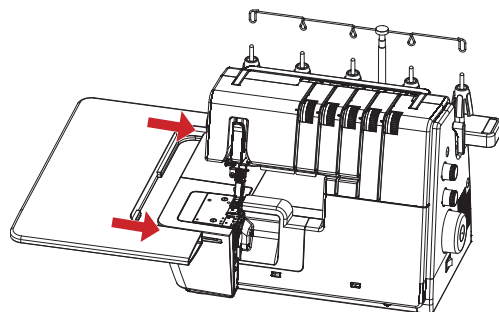


Attaching/Removing the Slide-on Table

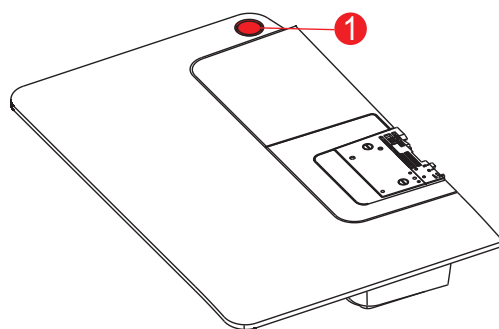
The slide-on table increases the sewing surface, which is especially helpful with larger sewing projects.

Prerequisite:

- The freearm cover is removed.
- > To attach the slide-on table, push the slide-on table along the guide rails from the left until it engages.



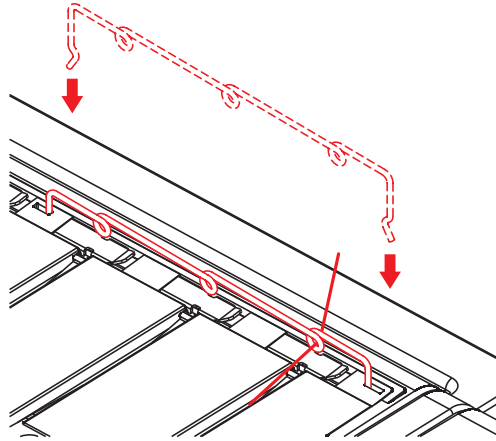
- > To remove the slide-on table, press the release mechanism (1) of the slide-on table and pull the slide-on table to the left.



Attaching the Decorative Threads Guide

The deco thread guide releases the thread tension adjustment from overstretching the thread.

- > Press the deco thread guide together slightly and hook it into the left and right recesses in the machine cover.
- > Thread the thread through the thread guide eyelet and insert it along the thread path between the thread tension discs.



Fitting Deco Thread Guide with Thread Already Inserted

- > Pull the thread out of the thread pretension.
- > Attach one end of the deco thread guide.
- > Thread the thread into the deco thread guide.
- > Attach the second end of the deco thread guide.

4 Sewing Start

4.1 Check before Starting to Sew

In order to start a project successfully, the following steps must be performed:

- The machine is switched on, and the presser foot is lifted.
 - The fabric and the applications have been selected. (see page 37)
 - The thread has been selected. (see page 37)
 - The needle size matches with the thread type and the sewing project. (see page 39)
 - The stitch is selected.
 - The machine settings based on the stitch selection have been performed. (see page 53)
 - Needle and looper threads are threaded.
 - All needle threads and looper threads lie under the presser foot to the back left.
 - The threader cover is closed.
- > Place the test fabric under the presser foot and lower the presser foot.
- > To start the sewing process, press the foot control.
- The set stitch is formed.
 - If no stitch is formed, the settings on the machine for the stitch must be checked.

4.2 Selecting the Fabric

The choice of fabric, in combination with needle, thread and stitch, plays a vital role in achieving the perfect sewing result. The sewing test with the selected fabric is recommended. (see page 76)

4.3 Selecting the Thread

A wide range of sewing and special overlock threads are manufactured in various sizes and in different fiber combinations.

- The purchase of high-quality threads is recommended to achieve good sewing results.
- Use thread cones/spools which are suitable for cover machines.

NOTICE

Thread Breakage due to Incorrect Needle/Thread or Thread/Looper Matching

The thread needs to glide smoothly through the respective thread guides.

It must be possible to feed the thread through the looper or the needle eye without any resistance.

In the case of thick threads, elongate the stitch length and reduce the thread tension.

Needle Thread




Needle size and thread type must be carefully matched. The correct needle thickness depends on the selected thread as well as the fabric being used.

- The fabric type determines the thread type and point form.
- The thread type determines the needle size.

Needle sizes of 80/12 -100/16 can be used with this machine.

Thread Type	Needle Size
Polyester Overlock Thread No. 120	80 – 100
Polyester Multifilament < No. 120	80 – 90
Wooly nylon	80 – 100
Decorative thread/yarn	80 – 100
Metallic thread	80 – 100

Check the Needle/Thread Combination

	The needle/thread combination is correct if the thread is guided perfectly into the long groove and through the eye of the needle.
	The thread can break and cause skipped stitches if there is too much play in the long groove or eye of the needle.
	The thread can break and become jammed if it frays on the edges of the long groove and is not guided optimally through the eye of the needle.

Looper Thread

A wide variety of thread types can be used as looper thread which can be threaded using the air threader system.

NOTICE

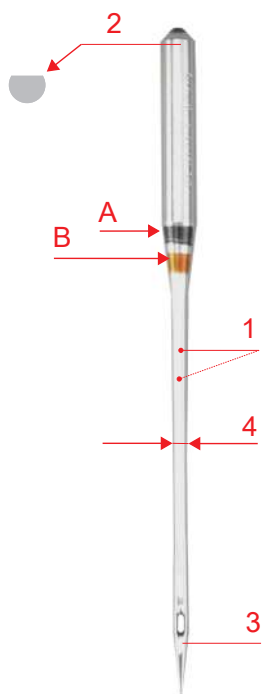
Damage by Coated or Waxed Threads

Coated or waxed threads may lose some of their coating in the air threader pipes. This results in permanent blocking of the pipes. A repair by the authorized bernette dealer is required.

- > Avoid the use of coated or waxed threads.

4.4 Selecting the Needle

It is recommended to use the needle type ELx705 CF (Chrome Finish) version as they are more durable due to the chrome coating. The machine runs most reliably with these needles because of their second groove. The needles should be replaced regularly. Only a perfect needle point can achieve a proper stitch.

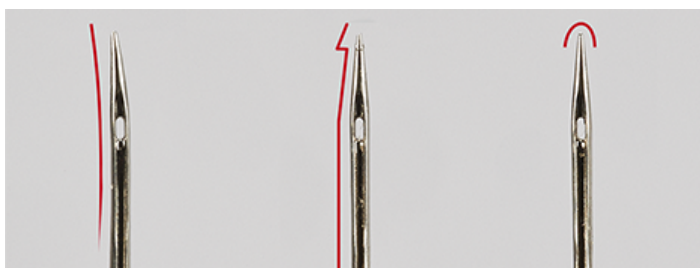


- | | | | |
|---|---------------------------------|-------|------------------|
| A | Coverstitch Needle ELx705 CF/80 | 3 | CF = ChromFinish |
| 1 | Two Thread Grooves | 4 / B | 80 = Needle Size |
| 2 | 705 = Flat Shank | | |

- Needle size 80: For any common applications. for mid-weight to heavy fabrics.
- Needle size 90: for heavy fabrics.
- Needle size >90: In exceptional cases, only for very heavy fabrics.



Detect Defective Needles

Check the needle before each sewing start and replace it if necessary.



- | | | | |
|---|----------------------|---|--------------|
| 1 | Bent Needle | 3 | Blunt Needle |
| 2 | Damaged Needle Point | | |

Needle Overview

Illustration	Designation	*Size	Description	Material/Application
	Coverstitch Needle ELx705 CF	80/12 90/14 100/16	With slightly rounded point, a second groove and chrome coating.	For overlocking and coverstitching applications.
	Jersey/Coverstitch Needle ELx705 SUK CF	80/12 90/14 100/16	With slightly rounded point, a second groove and chrome coating.	For overlocking and coverstitching on multilayer, elastic fabrics.

*Not all needle sizes are available as BERNINA Needles.

4.5 Fixing Fabric Layers

If several layers of fabric are sewn together, they can be fixed with basting stitches sewn on the sewing machine or by pins.

NOTICE

Damage to the Knife

Pins placed too close to the fabric edge can be caught by the knife. The needle tips can be sheared off or the blade of the knife can be damaged.

Position the pins at an adequate distance from the edge of the fabric.

- > Place the pins approx. 2 cm from the edge of the fabric or remove them continuously while sewing.

5 Selecting a Stitch

5.1 Stitch Type

With this machine different stitch formations can be set. These stitches are achieved by different configurations of needles and mechanical settings.

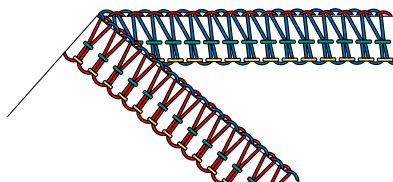
Overlock Stitch

The 3- and 4-Thread Overlock are considered standard overlock stitches for sewing two layers of fabric together, for finishing cut edges, e. g. facings, hem edges and seam allowances that are ironed apart.

The 2-Thread Overlock is ideal for finishing a fabric edge.

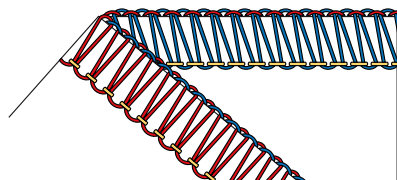
4-Thread Overlock

The 4-Thread Overlock is the most durable stitch thanks to the safety seam. The left and right overlock needle thread as well as the upper and lower looper thread are required for this stitch. The overlock needle threads form two parallel stitch rows, which on the front side look like step stitch rows of a sewing machine. On the wrong side, the overlock needle threads form «dots» to catch the under looper thread when the fabric is pierced, whereby the right overlock needle thread also serves as a safety seam.



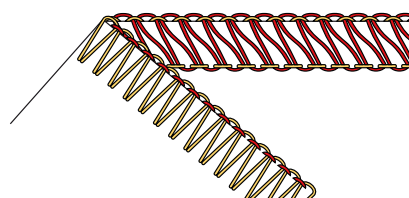
3-Thread Overlock

The 3-Thread Overlock is usually stretchable than the 4-Thread. Therefore it is ideal for seams on knitted fabrics (LN wide) or fine fabrics (RN narrow).



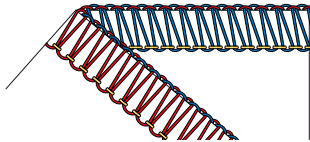
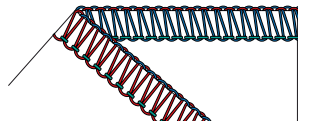
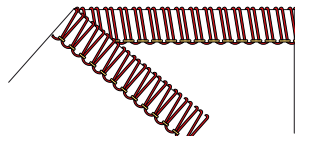
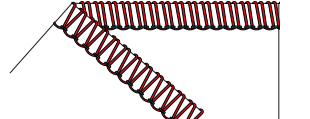
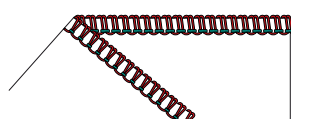
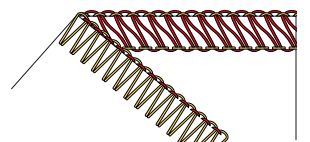
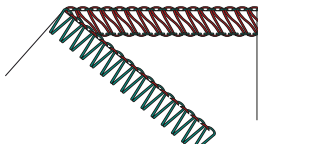
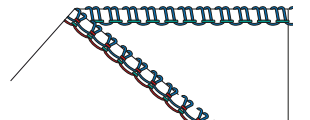
2-Thread Overlock

The 2-Thread Overlock is formed with an overlock needle thread (LN wide or RN narrow) and the under looper thread. The lower looper thread is guided to the right side of the fabric by means of the hooked-in upper looper converter. This overlock stitch is only suitable for edge finishing.



Finishing Edges

The finishing of a fabric edge is mostly used as preparation for open seams or as a decorative edge finish.

Stitch Number	Stitch Name	Stitch Pattern
No. 3	3-Thread Overlock Wide (LN)	
No. 4	3-Thread Overlock Narrow (RN)	
No. 9	2-Thread Wrapped Overlock Wide (LN)	
No. 10	2-Thread Wrapped Overlock Narrow (RN)	
No. 13	2-Thread Rolled Hem	
No. 14	2-Thread Overlock Wide (LN)	
No. 15	2-Thread Overlock Narrow (RN)	
No. 30	3-Thread Picotstitch	

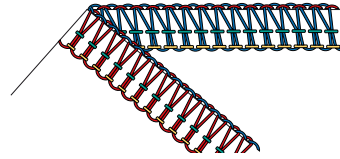
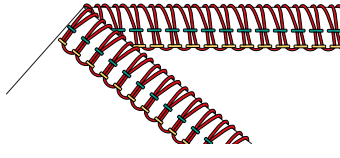
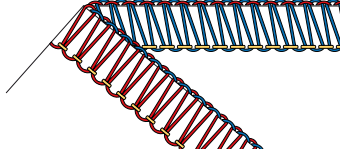
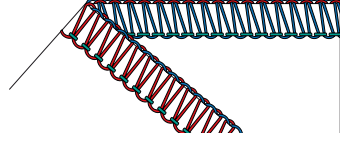
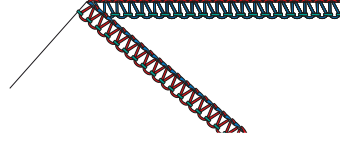
Seam

Seams are at least two layers of fabric, which are usually placed right side on right side and then sewn together. There are two different types of seams.

- Closed Seams
- Flat Seams

Closed Seam

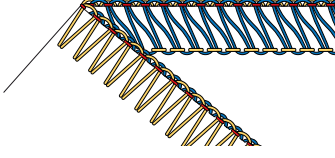
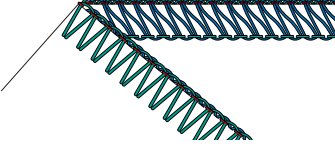
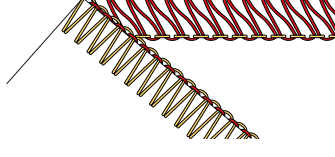
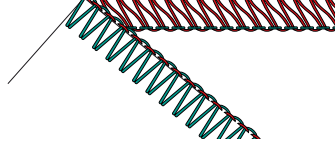
For closed seams 3-Thread or 4-Thread Overlock Stitches are suitable, because they loop around both fabric edges and sew them together. These stitches are mainly chosen for garments made of knitted fabrics and for wide cut garments made of woven fabrics.

Stitch Number	Stitch Name	Stitch Pattern
No. 1	4-Thread Overlock with Integrated Safety Seam	
No. 2	3-Thread Super Stretch	
No. 3	3-Thread Overlock Wide (LN)	
No. 4	3-Thread Overlock Narrow (RN)	
No. 7	3-Thread Rolled Seam	

Flatlock for Flat Seams

The flatlock forms loops on the upper side of the seam and stitches on the underside.

- > Thread and set the machine for 2- or 3-Thread Flatlock.
- > Sew two layers of fabric together (wrong side on wrong side).
- > Carefully separate the two layers of fabric.
 - The two fabric edges now lie flat on top of each other at the stitch width of the flatlock.

Stitch Number	Stitch Name	Stitch Pattern
No. 5	3-Thread Flatlock Wide (LN)	
No. 6	3-Thread Flatlock Narrow (RN)	
No. 11	2-Thread Flatlock Wide (LN)	
No. 12	2-Thread Flatlock Narrow (RN)	

Coverstitch

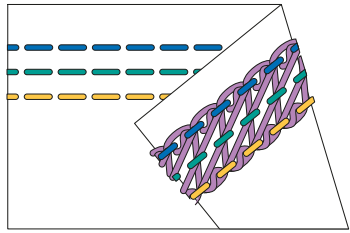
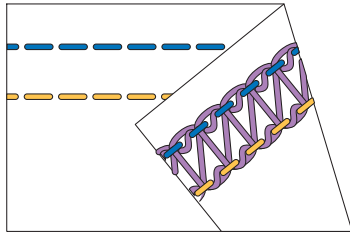
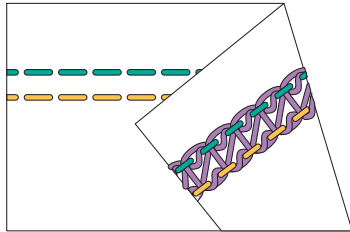
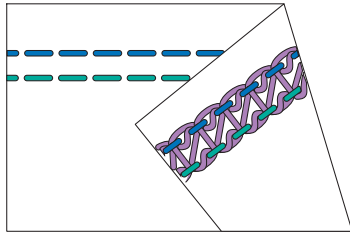
Hem

Coverstitch hems on garments, having been sewn with the machine, look very professional.

3- / 4-Thread Coverstitch

The coverstitch consists of 2 - 3 needle threads on the right side and 1 looper thread on the wrong side of the fabric.

Cover and chainstitch seams allow the option to sew without cutting the edges. These seams can be used in many different ways, for both functional and decorative purposes: Seams, hems, bordering.

No.	Stitch Name	Stitch Pattern
21	4-Thread Coverstitch	
22	3-Thread Coverstitch Wide (LC-RC)	
23	3-Thread Coverstitch Narrow (LC-CC)	
24	3-Thread Coverstitch Narrow (CC-RC)	

Tab. 1: 3- / 4-Thread Coverstitch

Decorative Seam

Coverstitches and chainstitches can be used for decorative sewing. The wrong side of the seam is especially attractive when multicolor thread is used in the looper.

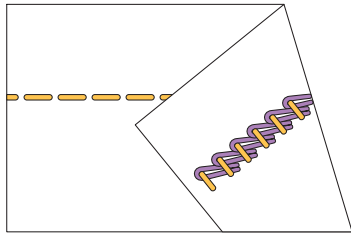
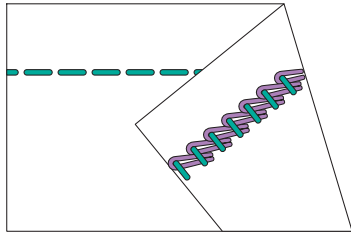
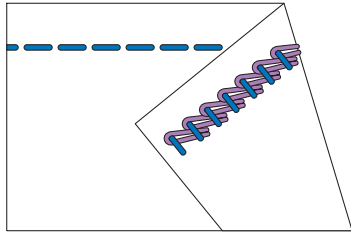
Chainstitch

Basting

The chainstitch is ideal for basting, e.g. in the provisional assembly of garments for fitting, when sewing costumes or with alterations to be made. Due to the loop structure of the stitch, the seam can be undone simply by pulling the looper thread.

2-Thread Chainstitch

The 2-Thread Chainstitch looks like a straight stitch on the right side of the fabric, and on the wrong side it forms a chain. With a decorative thread in the chain looper and the needle, the chainstitch looks more distinctive and is more prominent. With such a chain looper/needle thread combination many creative possibilities are given. Due to the loop structure of the stitch, the seam can be undone simply by pulling the chain looper thread.

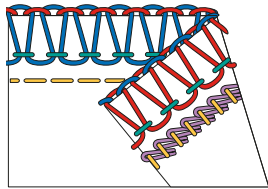
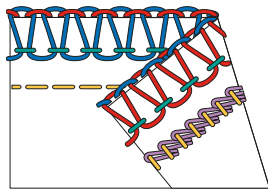
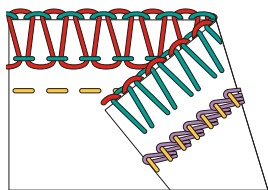
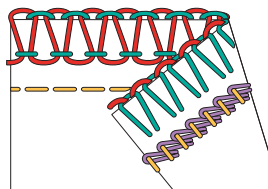
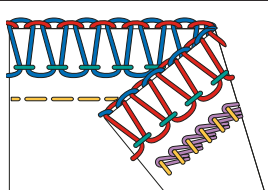
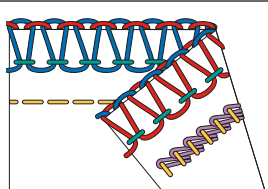
No.	Stitch Name	Stitch Pattern
16	2-Thread Chainstitch (LC)	
32	2-Thread Chainstitch (CC)	
33	2-Thread Chainstitch (RC)	

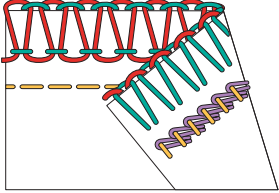
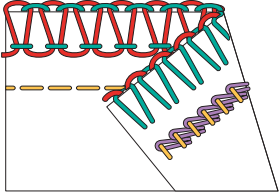
Tab. 2: Chainstitch

Combostitch

Seam

3-/2-Thread Overlock with Chainstitch

No.	Stitch Name	Stitch Pattern
No. 34	3-Thread Overlock (LN) + 2-Thread Chainstitch (CC)	
No. 35	3-Thread Overlock (RN) + 2-Thread Chainstitch (CC)	
No. 36	2-Thread Overlock (LN) + 2-Thread Chainstitch (CC)	
No. 37	2-Thread Overlock (RN) + 2-Thread Chainstitch (CC)	
No. 38	3-Thread Overlock (LN) + 2-Thread Chainstitch (LC)	
No. 39	3-Thread Overlock (RN) + 2-Thread Chainstitch (LC)	










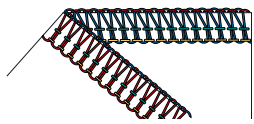
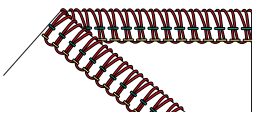

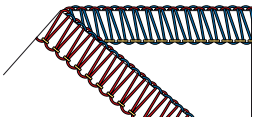
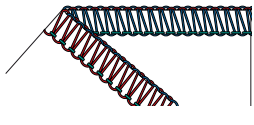
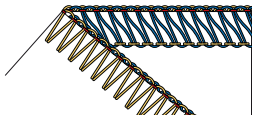
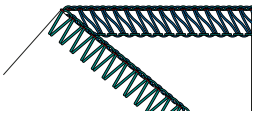
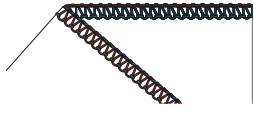
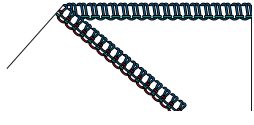
No.	Stitch Name	Stitch Pattern
No. 40	2-Thread Overlock (LN) + 2-Thread Chainstitch (LC)	
No. 41	2-Thread Overlock (RN) + 2-Thread Chainstitch (LC)	

Tab. 3: Recommended stitches for a durable closed seam










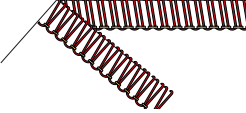





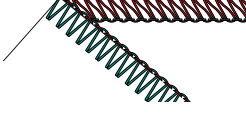

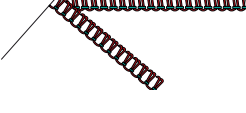

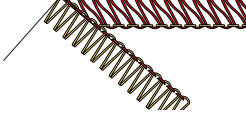

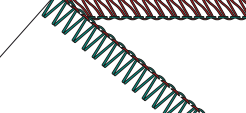

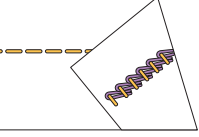
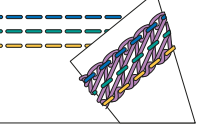
5.2 Stitch Chart










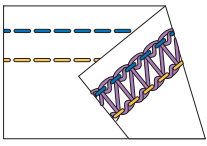
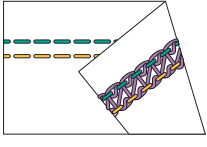
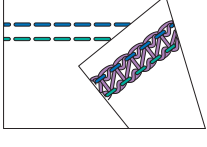
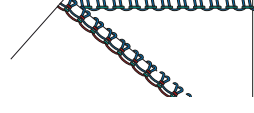
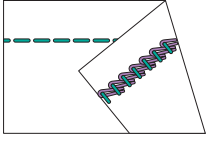
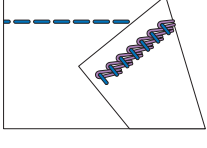
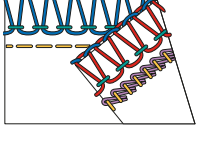
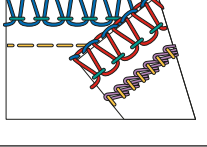
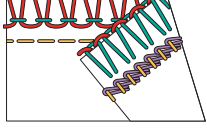

This manual includes a stitch overview with all necessary default settings for each stitch. These default values may vary depending on the used material.

- > Remove all the needles which are not required.
- > Set the mtc micro thread control to center position.










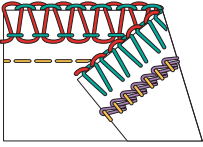

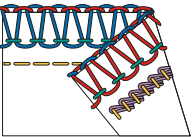
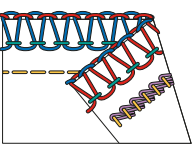
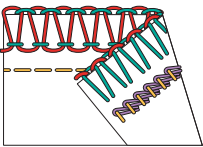

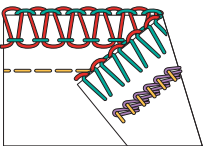

No.	Stitch Name	Stitch Pattern									
No. 1	4-Thread Overlock with Integrated Safety Seam		4	4	4	4	—	6	N	2.5	1
No. 2	3-Thread Super Stretch		5	4		4	—	6	N	2.5	1
No. 3	3-Thread Overlock Wide (LN)		4	—	4	4	—	6	N	2.5	1
No. 4	3-Thread Overlock Narrow (RN)		—	4.5	4	4	—	6	N	2.5	1
No. 5	3-Thread Flatlock Wide (LN)		0	—	5	8	—	6.5	N	2.5	1
No. 6	3-Thread Flatlock Narrow (RN)		—	0	6.5	8	—	5.5	N	2.5	1
No. 7	3-Thread Rolled Seam		—	4.5	5	4	—	6	R	1.5	1
No. 8	3-Thread Rolled Hem		—	4.5	5	7	—	5	R	1.5	1

Selecting a Stitch

No.	Stitch Name	Stitch Pattern									
No. 9	2-Thread Wrapped Overlock Wide (LN)		3	—		3.5	—	6	N	2.5	1
No. 10	2-Thread Wrapped Overlock Narrow (RN)		—	5		4	—	6	N	2.5	1
No. 11	2-Thread Flatlock Wide (LN)		0.5	—		7	—	5.5	N	2.5	1
No. 12	2-Thread Flatlock Narrow (RN)		—	3		7.5	—	6	N	2.5	1
No. 13	2-Thread Rolled Hem		—	5		4.5	—	5.5	R	1.5	1
No. 14	2-Thread Overlock Wide (LN)		0.5	—		7	—	5.5	N	2.5	1
No. 15	2-Thread Overlock Narrow (RN)		—	3		7.5	—	6	N	2.5	1
No. 16	2-Thread Chainstitch (LC)		6	—	—	—	4	—	R	3	1
No. 21	4-Thread Coverstitch		3	6	6	—	4	—	R	3	1

No.	Stitch Name	Stitch Pattern									
No. 22	3-Thread Coverstitch Wide (LC-RC)		2.5	—	4.5	—	4	—	R	3	1
No. 23	3-Thread Coverstitch Narrow (LC-CC)		3.5	6	—	—	4	—	R	3	1
No. 24	3-Thread Coverstitch Narrow (CC-RC)		—	4.5	6	—	4	—	R	3	1
No. 30	3-Thread Picotstitch		—	4.5	4	5.5	—	5.5	R	3	1
No. 32	2-Thread Chainstitch (CC)		—	6	—	—	4	—	R	3	1
No. 33	2-Thread Chainstitch (RC)		—	—	6	—	4	—	R	3	1
No. 34	3-Thread Overlock (LN) + 2-Thread Chainstitch (CC)		3.5	6.5	4	4	4	6	N	3	1
No. 35	3-Thread Overlock (RN) + 2-Thread Chainstitch (CC)		3.5	4.5	4	4	4	6	N	3	1
No. 36	2-Thread Overlock (LN) + 2-Thread Chainstitch (CC)		3.5	0		6	4	6	N	3	1

Selecting a Stitch

No.	Stitch Name	Stitch Pattern									
No. 37	2-Thread Overlock (RN) + 2-Thread Chainstitch (CC)		3.5	0		6	4	6	N	3	1
No. 38	3-Thread Overlock (LN) + 2-Thread Chainstitch (LC)		3.5	6.5	4	4	4	6	N	3	1
No. 39	3-Thread Overlock (RN) + 2-Thread Chainstitch (LC)		3.5	4.5	4	4	4	6	N	3	1
No. 40	2-Thread Overlock (LN) + 2-Thread Chainstitch (LC)		3.5	0		6	4	6	N	3	1
No. 41	2-Thread Overlock (RN) + 2-Thread Chainstitch (LC)		3.5	0		6	4	6	N	3	1

6 Machine Settings

6.1 Preparing the Machine for Overlock or Overlock/Chainstitch Combo

The machine can be set up for finishing the fabric edge with fabric cut with just a few movements.

Prerequisite:

- The looper cover is opened.
- > Set the «Upper Looper On/Off» to the right.
- > Adjust the knife according to the stitch settings.
- > Knife cover insert is attached.
 - The machine is prepared for overlock or overlock/chainstitch combo.
- > Perform the sewing start. (see page 37)

6.2 Preparing the Machine for Cover- and Chainstitch

For hemming, basting or sewing together without cutting the fabric, the machine can be set up for coverstitch or chainstitch with just a few movements.

- > Set the «Upper Looper On/Off» to the left.
- > Adjust the knife according to the stitch settings.
- > Coverstitch insert is attached.
 - The machine is prepared for a coverstitch or a chainstitch.
- > Perform the sewing start. (see page 37)

6.3 Setting the Knife

Knife «On/Off»

For a better overview and better access in the sewing area, e. g. for threading, the knife can be lowered (off) and then engaged again (on). The knife is also lowered if the sewing project already has a clean cut edge and the edge is only to be finished. The best sewing results are achieved by cutting and finishing in one single step.

NOTICE

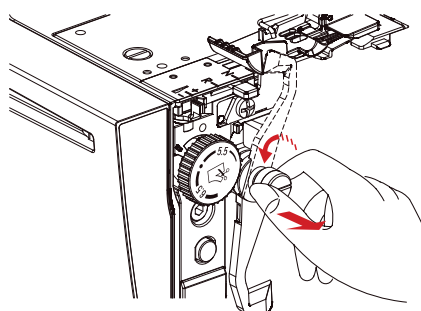
Missing Knife Cover Insert or Coverstitch Insert while Sewing

Injuries caused by the knife or by the looper movement.

Before each sewing, check whether the mounted knife cover insert or the coverstitch insert is attached.

Knife «Off» (to lower)

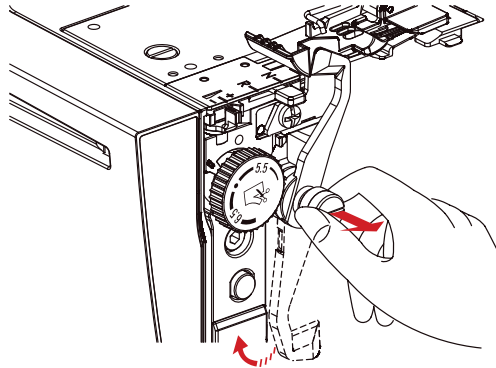
- > Open the threader cover.
- > Pull the knife away from the stitch plate as far as possible and then lower it forwards to the lock-in position.



- > Close the threader cover.

Knife «On» (to lift)

- > Open the threader cover.
- > Pull the knife away from the stitch plate as far as possible and then lift it backwards to the lock-in position.



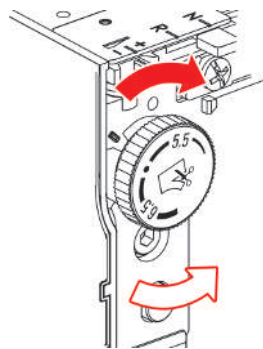
- > Close the threader cover.

Setting the Cutting Width



The cutting width for the knife position can be adjusted between 5 – 7 mm. The numbers on the scale correspond with the actual cutting width in mm from the left overlock needle «LN» to the cutting edge. The cutting width is used to determine the stitch width. Towards the right overlock needle, the cutting width is reduced by 2 mm. The cutting width has a direct effect on the stitch width. (see page 55)

If the cutting width changes, the knife, the stitch finger and the threader cover move in the corresponding direction.






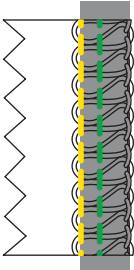
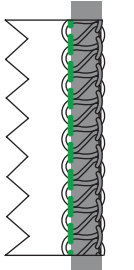
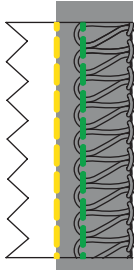
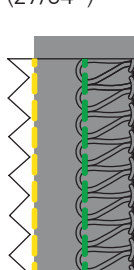

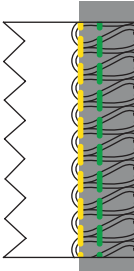
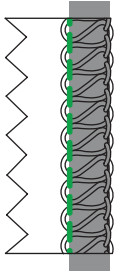
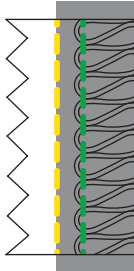
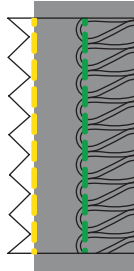

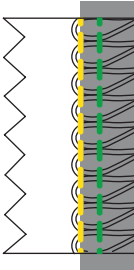
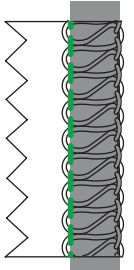
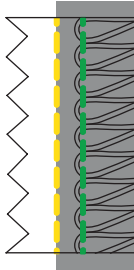
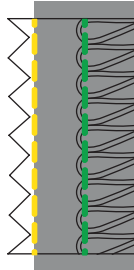


- > To increase the cutting width, turn the cutting width dial to a higher value.
- > To reduce the cutting width, turn the cutting width dial to a lower value.

Adjusting the Stitch Width

The stitch width can be adjusted in two different ways.

- Needle Position
- Cutting Width

Cutting Width	Needle Position in Relation to the Cut Edge			
				
CW 5 	5 mm (13/64") 	3 mm (1/8") 	7.8 mm (5/16") 	10.6 mm (27/64") 
CW 6 	6 mm (15/64") 	4 mm (10/64") 	8.8 mm (11/32") 	11.6 mm (29/64") 
CW 7 	7 mm (17/64") 	5 mm (3/16") 	9.8 mm (3/8") 	12.6 mm (31/64") 

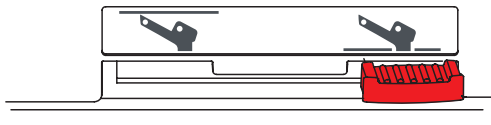
6.4 Setting the Upper Looper On/Off



Activating the Upper Looper

Prerequisite:

- Threader cover is opened.
- > Set the «Upper Looper On/Off» to the right.
- > Turn the handwheel until the upper looper is activated.
 - Upper looper is activated.



- > Attach the knife cover insert.



Deactivating the Upper Looper

Prerequisite:

- The threader cover is opened.
- The upper looper converter is hooked out.
- The upper looper is in lowest position.
- > Set the «Upper Looper On/Off» to the left.
 - The upper looper is deactivated.



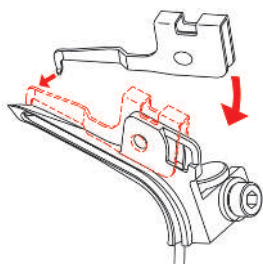
- > Attach the coverstitch insert.

6.5 Upper Looper Converter Hooked in/Hooked out

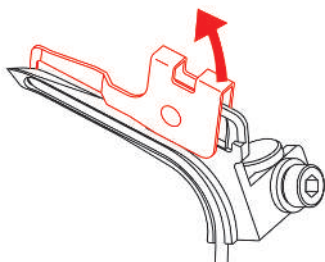
By attaching the upper looper converter, the upper looper grabs the lower looper thread so that it covers the entire fabric edge.

Prerequisite:


- The needles are in the top position.
 - The upper looper thread is removed.
 - The lower looper thread is below the upper looper.
- > To hook in the upper looper cover, place the end of the upper looper cover over the elevation of the upper looper and hook the tip of the upper looper cover into the looper eye.



- > To unhook the upper looper cover, lift the end of the upper looper cover upwards and unhook the lock-in lug from the looper eye.



6.6 Setting the Stitch Length

- 
 The stitch length can be infinitely adjusted between 1.0 – 5.0 mm while sewing.
- > To elongate the stitch, set the stitch length knob to a higher value.
 - > To shorten the stitch, set the stitch length knob to a lower value.

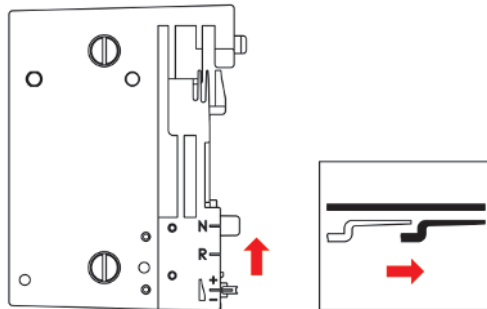
6.7 Rolled Hem Selection Lever «N/R»

Depending on the application, the rolled hem selection lever must be set to the appropriate position.

Setting Overlocking «N»

During overlocking, the upper and lower looper threads are laid around the stitch finger and this creates an even distance to the cut edge. If the thread quantity at the fabric edge is too much or too little, this thread quantity can be corrected by the mtc micro thread control. (see page 59)

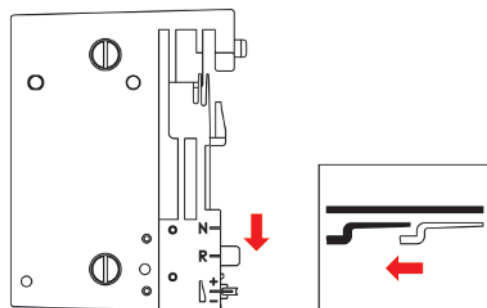
- > Move the rolled hem selection lever to position «N».
 - Overlocking is activated.



Setting Rolled Hem «R»

By retracting the stitch finger, the loops of the upper and lower loopers thread are reduced and the fabric edge is rolled under. Rolled hems are the ideal edge finishing for fine fabrics. These are particularly suitable for decorative finishings on scarves, evening gowns, lingerie, home textiles and as lining seams.

- > Move the rolled hem selection lever to position «R».



- The rolled hem is activated.
- The stitch finger is retracted.

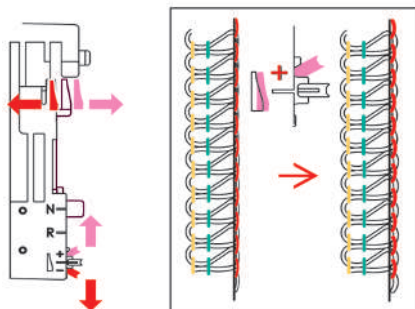
6.8 Setting the mtc micro thread control

The mtc micro thread control affects the amount of the looper thread around the fabric edge and can be adjusted continuously while sewing. This feature makes it easy to achieve a well-balanced stitch at any given cutting width.

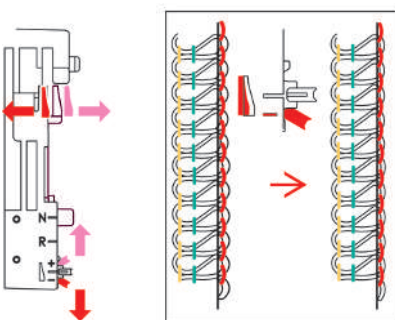
Prerequisite:

- The thread tension is set correctly.
- The knife position is set correctly.
- The mtc micro thread control is set to «-».
- The sewing test has been performed.

> To enlarge the loops of the looper thread at the fabric edge, turn the mtc micro thread control in «+» direction while sewing.




> To minimize the loops of the looper thread at the fabric edge, turn the mtc micro thread control in «-» direction while sewing.

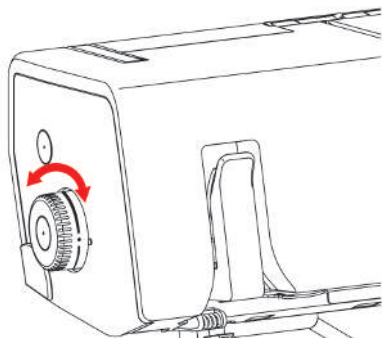


6.9 Setting the Presser Foot Pressure


The presser foot pressure on the machine has been set by the factory so that it is optimal to sew medium-weight fabrics. Most materials do not require any adjustment of the presser foot pressure. In some cases, it is required to make adjustments such as when sewing very light or heavy fabrics.

	Extra-high
	High
	Medium-high
	Default value
	Medium-light
	Light
	Extra-light

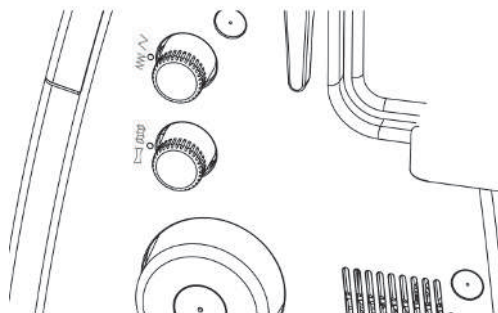
- > For light fabrics, reduce the presser foot pressure.
- > For heavy fabrics, increase the presser foot pressure.
- > Perform a sewing test to set the optimal presser foot pressure for your sewing project.
- > To increase the presser foot pressure, set the presser foot pressure wheel to a higher value.
- > To reduce the presser foot pressure, set the presser foot pressure wheel to a lower value.



6.10 Adjusting the Differential Feed

 The differential feed prevents unwanted puckering or wavering in knitted or stretch fabrics as well as shifting of fabric layers. The setting values describe the ratio of movement of front feed dog relative to the rear feed dog. With default value 1, both feed dogs move at the same speed.

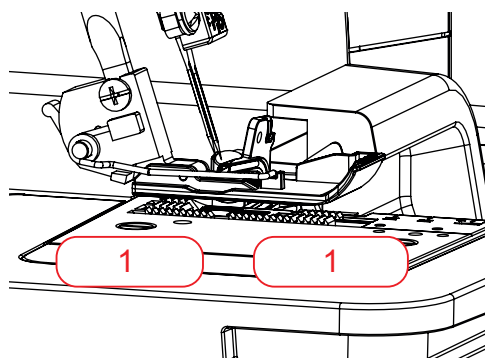
> Adjust the feeding ratio of the two feed dogs by using the differential feed setting.



Value	Fabric	Result
2	Fine, soft fabrics	Ruffling, puckering, gathering
1.5	Jersey, sweatshirt, knits	Slight ruffling, preventing seam wavering
1	Woven knit and medium-weight dense fabric	Default value
0.6	Fine nylon tricots, densely woven fabric, lining, satin	Stretching, preventing seam puckering

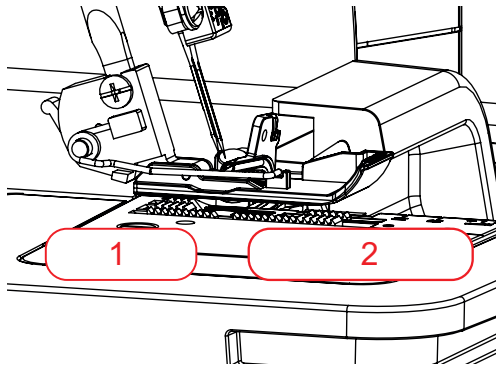
Default Value "1"

In a default value of 1, the machine achieves optimum sewing results with most applications. The differential feed in default setting 1 for flat and even seams.



Gathering/Gather to fit "1.5 – 2"

At a setting of 1.5 - 2 the front feed dog (2) covers a longer distance than the rear feed dog (1).



Gathering

> To gather intentionally, increase the differential feed to a value between 1.5 and 2.



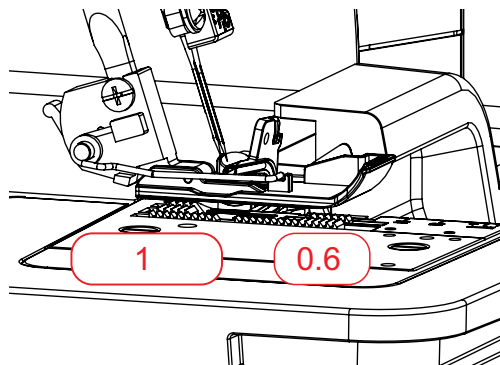
Gather to Fit

> To prevent waviness increase the differential feed to a value between 1 and 2.



Stretching "0.6"

The front feed dog (0.6) covers a shorter distance than the rear feed dog (1). The material is stretched under the presser foot which helps to reduce puckering. This setting can also be used to deliberately stretch the material.

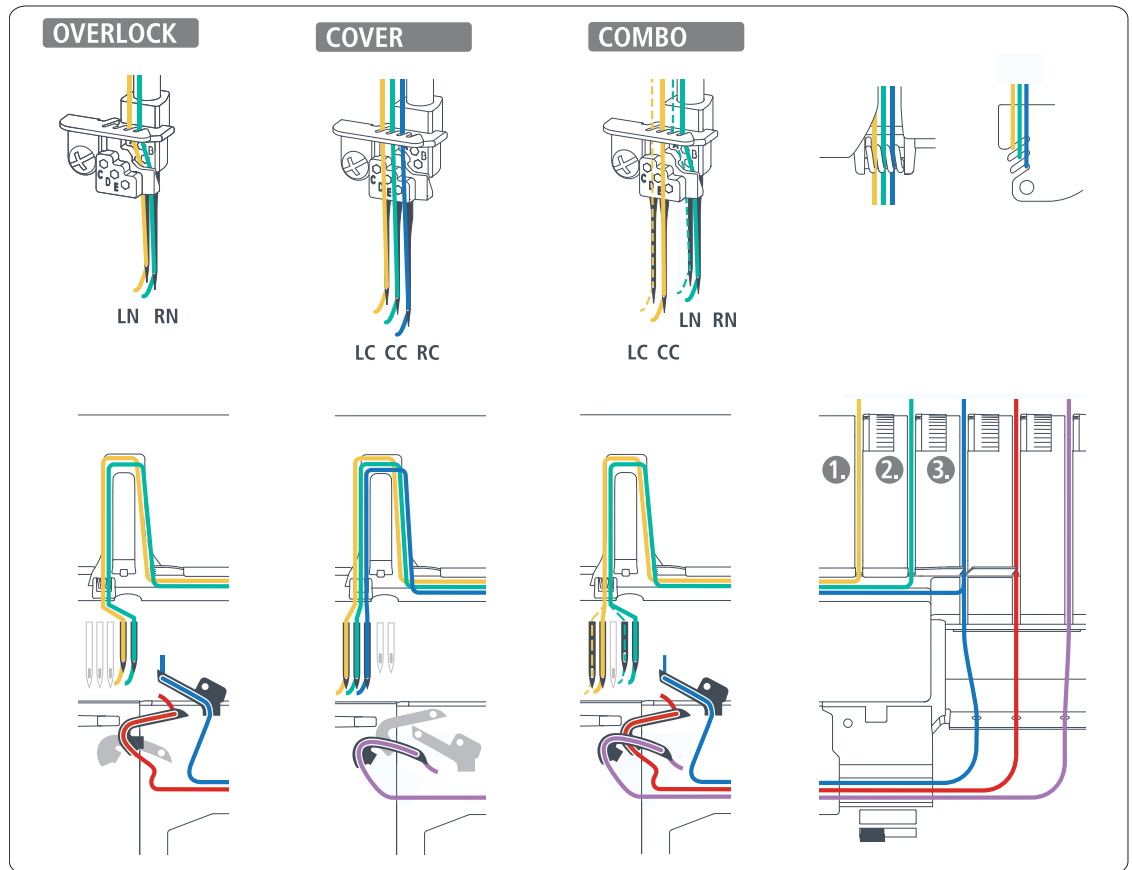


> To prevent seam puckering, reduce the differential feed to a value between 0.6 and 1.



7 Threading

The threading sequence is important for the correct stitch formation.



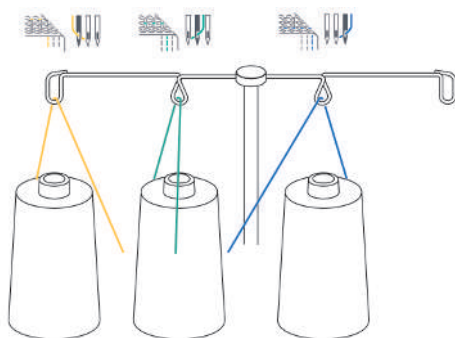
7.1 Preparing for Threading

Before threading, make sure that the machine settings match with the required stitch.

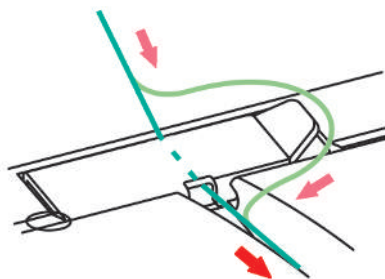
The machine has color-coded threading paths. Correct threading is ensured when following the color markings.

Prerequisite:

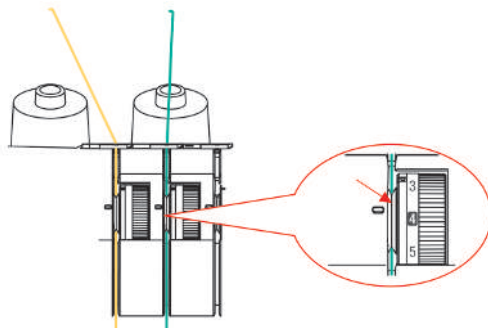
- The retractable thread guide is fully extended.
 - The needles are at the top position.
 - All threads and needles that are not needed for the particular stitch have been removed.
- > Raise the presser foot.
- The thread tensions are released and the thread can be inserted without resistance.
- > Place the thread cones on the respective spool pin.
- > Place the thread from the back through the thread guide.



- > Engage the thread in the thread pretension.



- > Place the thread along the thread path between the thread tension discs.



7.2 Threading the Needle Thread

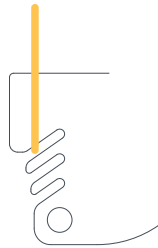
Detailed information can be found in the stitch chart.

Threading the Left Overlock Needle Thread LN/Yellow

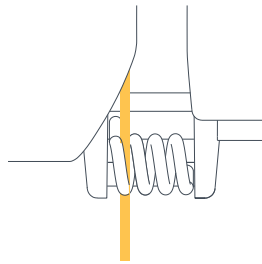
- ▶ The left needle thread path is marked in yellow.

Prerequisite:

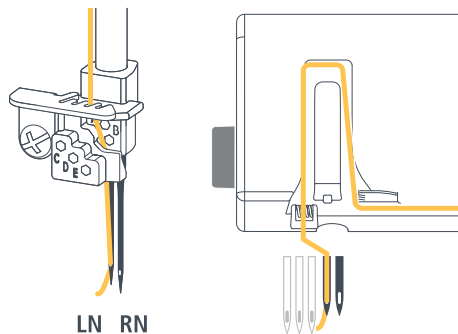
- Threading is prepared.
- > Pull the thread beneath the thread guide plate to the left and up through the rearmost opening of the thread deflection finger.



- > Place the thread along the colored marking, then over the needle thread take-up cover and pull it towards the needle.



- > Insert the thread into the left thread guide on the machine.
- > Hook the thread into the left thread guide at the needle holder.



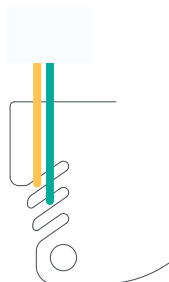
- > Thread the left overlock needle (LN).
- > Place the thread beneath the presser foot to the back left.

Threading the Right Overlock Needle Thread RN/Green

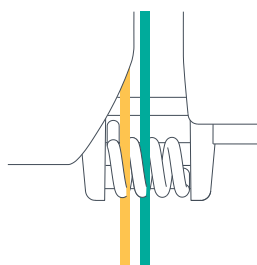
- The right needle thread path is marked green.

Prerequisite:

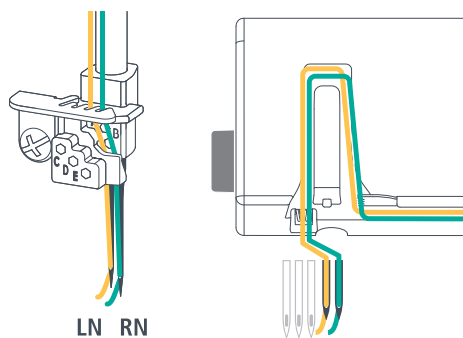
- Threading is prepared.
 - The left needle thread is threaded.
- > Pull the thread beneath the thread guide plate to the left and up through the center opening of the thread deflection finger.



- > Place the thread along the colored marking, then over the needle thread take-up cover and pull it towards the needle.



- > Insert the thread into the right thread guide on the machine.
> Hook the thread into the right thread guide at the needle holder.



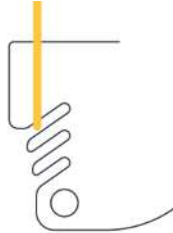
- > Thread the right overlock needle (RN).
> Place the thread beneath the presser foot to the back left.

Threading the Left Coverstitch Needle Thread LC/Yellow

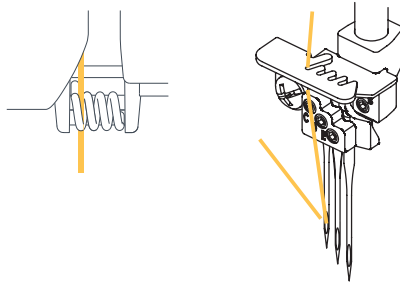
- ◡ The left coverstitch needle thread is marked in yellow all along the thread path.

Prerequisite:

- «Threading is prepared».
- > Pull the thread beneath the thread guide plate to the back left through the rearmost opening of the thread deflection finger.



- > Place the thread along the colored marking, then over the needle thread take-up cover and pull it towards the needle.
- > Hook the thread into the left thread guide of the needle holder.



- > Thread the needle eye.
- > Place the thread beneath the presser foot to the back left.
- > When all needed threads are threaded, lower the presser foot.

Threading the Center Coverstitch Needle Thread CC/Green

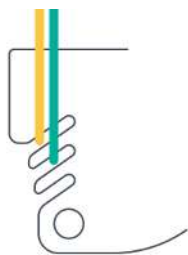
- The center coverstitch needle thread is marked in green all along the thread path.

Exception:

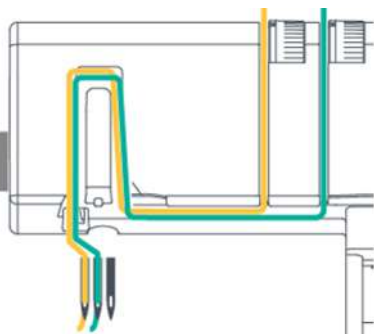
For a combostitch with chainstitch, the yellow thread path must be followed for the center coverstitch needle thread.

Prerequisite:

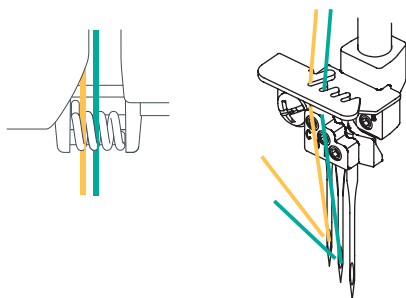
- «Threading is prepared».
- > Pull the thread beneath the thread guide plate to the back left through the center opening of the thread deflection finger.



- > Place the thread along the colored marking, then over the needle thread take-up cover and pull it towards the needle.



- > Hook the thread into the second thread guide from left of the needle holder.



- > Thread the needle eye.
- > Place the thread beneath the presser foot to the back left.
- > When all needed threads are threaded, lower the presser foot.

Threading the Right Coverstitch Needle Thread RC/Blue

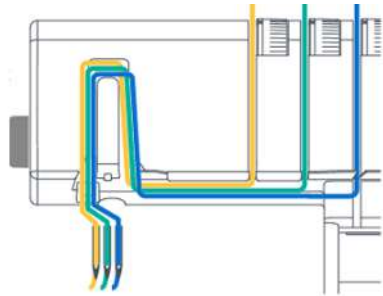
- The right coverstitch needle thread is marked in blue all along the thread path.

Prerequisite:

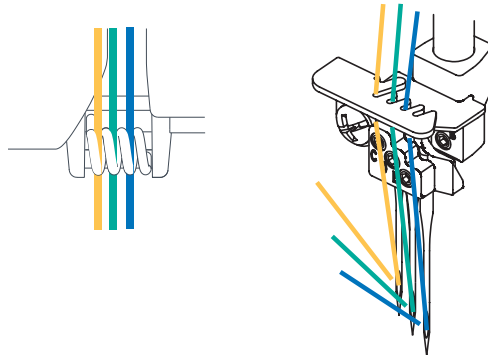
- «Threading is prepared».
- > Pull the thread beneath the thread guide plate to the back left through the first opening of the thread deflection finger.



- > Place the thread along the colored marking, then over the needle thread take-up cover and pull it towards the needle.



- > Hook the thread into the third thread guide from left of the needle holder.



- > Thread the needle eye.
- > Place the thread beneath the presser foot to the back left.
- > When all needed threads are threaded, lower the presser foot.

7.3 Threading the Loper Thread

At least one looper thread is required to form a stitch.

NOTICE

Damage by Coated or Waxed Threads

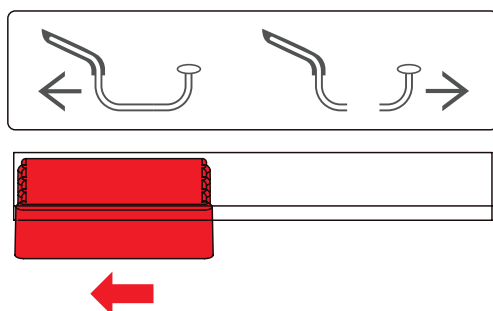
Coated or waxed threads may lose some of their coating in the air threader pipes. This results in permanent blocking of the pipes. A repair by the authorized bernette dealer is required.

Detailed information can be found in the stitch chart.

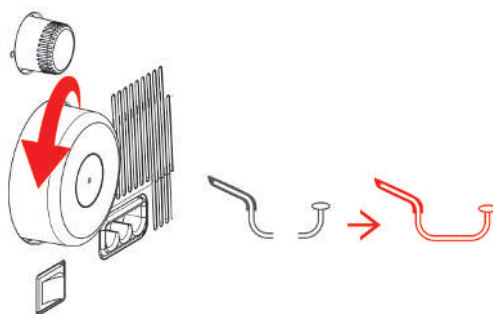
Using the Air Threader

Prerequisite:

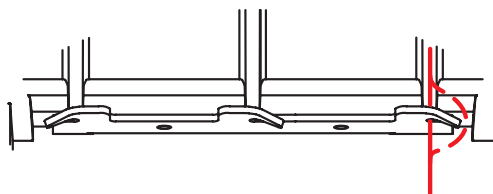
- Threading is prepared.
 - Threader cover is opened.
- > Set the air threader connector to the left position.



- > Slowly turn the handwheel counterclockwise until the air threader pipes couple.

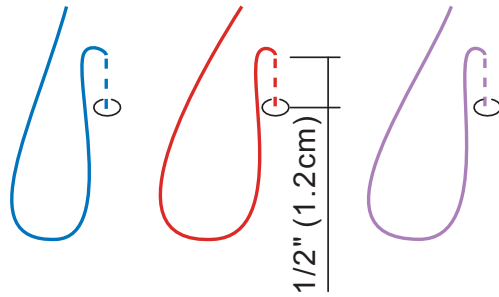


- > Feed the thread through the thread guide.

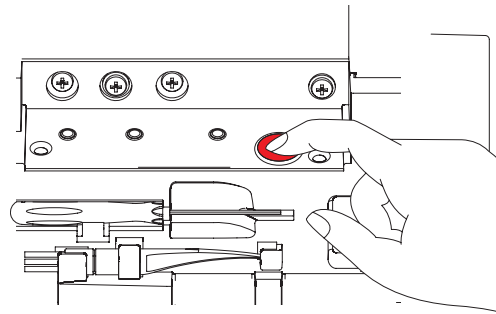


- > Pull off a thread reserve of approx. 56 cm so that the thread can be completely drawn through the air threader pipe.

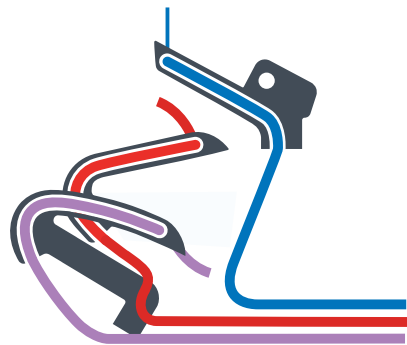
- > Place the end of the thread approx. 1.2 cm into the corresponding air threader nozzle.



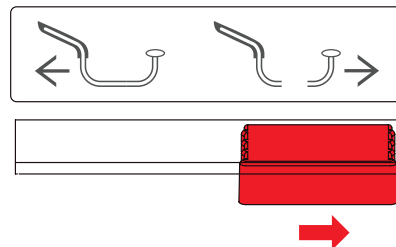
- > Press and hold the air threader button.



- Thread feed is started.
- The looper thread is shot through the air threader pipe and exits at the looper tip.
- > As soon as the looper thread exits out of the looper eye, release the air threader button.



- > Place the looper thread under the presser foot to the rear left.
- > Set the air threader connector to the right position.



- > Close the threader cover.

Threading the Looper Thread with an Auxiliary Thread

If a looper thread cannot be threaded automatically with the air threader, the use of an auxiliary thread makes sense.

Prerequisite:

- Threading is prepared.
- > Open the threader cover.
- > Move the air threader connector to the left.
- > Slowly turn the handwheel counterclockwise until the air threader pipes couple.
- > Prepare an auxiliary thread at a length of about 60 cm.
- > Fold the auxiliary thread in half, hold the thread end with the loop in your hand and position the two thread ends above the respective air threader nozzle.
- > Start the air threader process until the thread ends of the auxiliary thread emerge out of the looper eye.
- > Place the looper thread end at the length of about 20 cm through the loop of the auxiliary thread.
- > Pull the auxiliary thread ends until the thread exits the looper eye.
- > Remove the auxiliary thread.
- > Place the looper thread under the presser foot to the rear left.

Using the Threading Wire

If the air threader cannot be started for threading the looper threads, the use of the threading wire is a threading option. The threading wire is a wear part and not designed as a permanent threading or cleaning aid.

Any malfunctions of the air threader system must be repaired by an authorized bernette dealer.

NOTICE

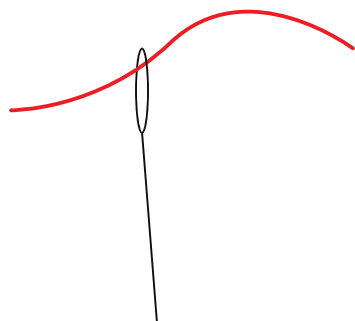
Damage by Improper Use of the Threading Wire

The air threader pipes may be damaged. A repair by the authorized bernette dealer is required.

- > Insert and pull through the threading wire only in the thread flow direction.

Prerequisite:

- There is no thread in the respective air threader pipe.
- Threading is prepared.
- > Open the threader cover.
- > Guide the threading wire end without loop through the corresponding air threader nozzle until it exits at the looper eye.
- > Place the wanted thread through the loop of the threading wire.



- > Pull the end of the threading wire until the looper thread exits from the looper eye.
- > Place the looper thread under the presser foot to the rear left.
- > Close the threader cover.

7.4 Changing the Thread

Knotting Thick Thread

Tying on two thread ends is often used for changing a needle thread or looper thread.

Keep the knotted area as little as possible to reduce friction.

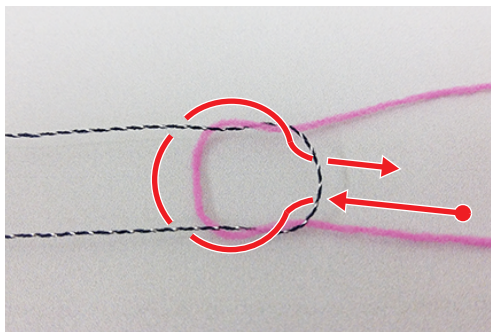
NOTICE

Pulling a Thread Tie through the Needle Eye

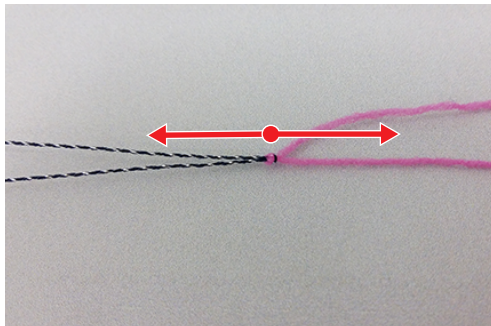
The needle can be bent. A bent needle affects the stitch formation.

> Cut the tie in front of the needle eye and thread the needle individually.

- > Form a loop with the dark thread.
- > Thread the pink thread end from beneath into the dark thread loop.
- > Guide the pink thread to the back around the two dark threads and from above through the loop.



> Hold both thread ends and pull them apart.



Changing the Needle Thread

NOTICE

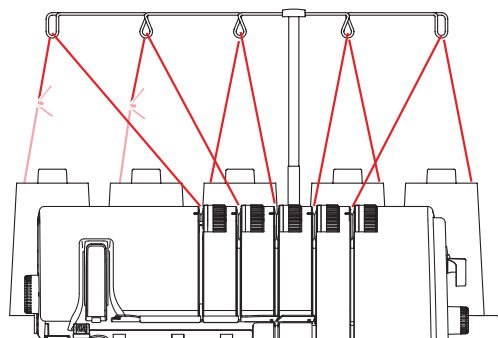
Pulling a Thread Tie through the Needle Eye

The needle can be bent. A bent needle affects the stitch formation.

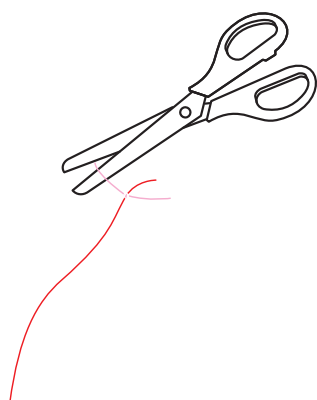
> Cut the tie in front of the needle eye and thread the needle individually.

- > Cut the thread above the thread cone.
- > Change the thread cone.

- > Tie the threaded thread to the new thread.



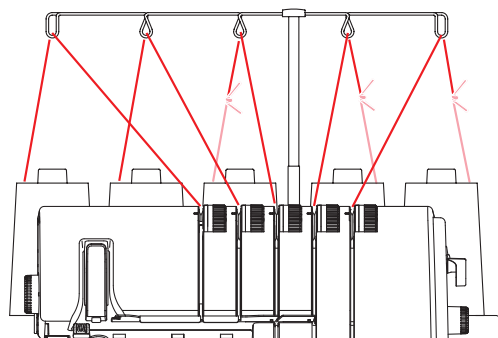
- > Pull the threaded end of the thread until the newly knotted thread is in front of the needle eye.
- > Cut off the new thread behind the knotting.



- > Remove the excess thread from the needle eye.
- > Thread the needle eye.
- > Place the thread under the presser foot to the left.

Changing the Loper Thread

- > Cut the thread above the thread cone.
- > Change the thread cone.
- > Tie the inserted looper thread to the new thread.



- > Pull the end of the thread out of the looper eye until the knot emerges.
- > Cut off the new thread behind the knotting.
- > Place the thread under the presser foot to the left.

8 Sewing Test

To check the optimal setting, a sewing test should be sewn on a spare piece of the fabric used for your project.

The default values of the stitches represent recommendations that work for most standard applications. Depending on the result of the sewing test, fine adjustments for stitch optimization are possible.

8.1 Performing a Sewing Test for an Overlock Stitch

Prerequisite:

- The sewing start has been performed.
- > Place the fabric under the presser foot to the front of the knife so that the desired seam allowance is cut off.
- > Press the foot control and sew slowly. Guide the fabric gently as the machine automatically feeds the material.
- > Sew beyond the fabric end such that a thread chain is formed.
- > Pull the thread chain over the thread cutter.
- > Assess the sewing test and make any necessary adjustments until the stitch setting matches the material combination.

8.2 Performing a Sewing Test for an Coverstitch

Prerequisite:

- The sewing start has been performed.
- > Raise the presser foot.
- > Place the fabric under the presser foot such that the presser foot lies completely on the fabric.
- > Lower the presser foot.
- > Press the foot control and start sewing slowly. Guide the fabric gently as the machine automatically feeds the material.
- > Do not sew beyond the end of the fabric.
- > Set the needles to topmost position.
- > Raise the presser foot.
- > Pull the needle thread between the fabric and the presser foot to the back with the coverstitch lock tool and cut it.
- > Pull the sewing project to the back left and cut the looper thread.
 - The seam end is secured.
- > Assess the sewing test and make any necessary adjustments until the stitch setting matches the material combination.

8.3 Performing a Sewing Test for an Chainstitch

Prerequisite:

- The sewing start has been performed.
- > Raise the presser foot.
- > Place the fabric under the presser foot such that the presser foot lies completely on the fabric.
- > Lower the presser foot.
- > Press the foot control and sew slowly. Guide the fabric gently as the machine automatically feeds the material.
- > Sew beyond the fabric end such that a thread chain is formed.
- > Raise the presser foot.
- > Pull the sewing project to the back left and pull the threads over the thread cutter.
 - The seam end is secured.
- > Assess the sewing test and make any necessary adjustments until the stitch setting matches the material combination.

8.4 Optimizing Stitches

4-Thread Overlock with Integrated Safety Seam

Stitch Formation	Measures
Looper threads (red/blue) form loops on the bottom side of fabric.	<ul style="list-style-type: none"> > Reduce LL-thread tension (red). > Increase UL-thread tension (blue).
Looper threads (red/blue) form loops on the top side of fabric.	<ul style="list-style-type: none"> > Reduce UL-thread tension (blue). > Increase LL-thread tension (red).
Needle thread (yellow) forms loops on bottom side of the fabric.	<ul style="list-style-type: none"> > Reduce LL-thread tension (red). > Increase LN-thread tension (yellow).
Needle thread (green) forms loops on bottom side of the fabric.	<ul style="list-style-type: none"> > Increase RN-thread tension (green).
The fabric edge forms a tunnel or curls.	<ul style="list-style-type: none"> > Reduce UL-thread tension (blue). > Reduce LL-thread tension (red). > Increase the mtc micro thread control. > Reduce the cutting width CW. > Check the rolled hem selection N/R position.
The seam puckers.	<ul style="list-style-type: none"> > Reduce LN-thread tension (yellow). > Reduce RN-thread tension (green). > Set the differential feed between 1 and 0.6 (stretching). > Reduce the stitch length SL.

3-Thread Super Stretch

Stitch Formation	Measures
Looper thread (red) wraps fabric edge too loosely.	<ul style="list-style-type: none"> > Increase LL-thread tension (red). > Reduce the mtc micro thread control. > Increase the cutting width CW.
Looper thread (red) wraps fabric edge too tightly.	<ul style="list-style-type: none"> > Reduce LL-thread tension (red). > Increase the mtc micro thread control. > Reduce the cutting width CW. > Check the rolled hem selection N/R position.
The fabric edge forms a tunnel or curls.	<ul style="list-style-type: none"> > Reduce LL-thread tension (red). > Increase the mtc micro thread control. > Reduce the cutting width CW. > Check the rolled hem selection N/R position.
Needle thread (yellow) forms loops on bottom side of the fabric.	<ul style="list-style-type: none"> > Reduce LL-thread tension (red). > Increase LN-thread tension (yellow).
Needle thread (green) forms loops on bottom side of the fabric.	<ul style="list-style-type: none"> > Increase RN-thread tension (green).

Stitch Formation	Measures
The seam puckers.	<ul style="list-style-type: none"> > Reduce LN-thread tension (yellow). > Reduce RN-thread tension (green). > Set the differential feed between 1 and 0.6 (stretching). > Reduce the stitch length SL.

3-Thread Overlock Wide (LN)

Stitch Formation	Measures
Looper threads (red/blue) form loops on the bottom side of fabric.	<ul style="list-style-type: none"> > Reduce LL-thread tension (red). > Increase UL-thread tension (blue).
Looper threads (red/blue) form loops on the top side of fabric.	<ul style="list-style-type: none"> > Reduce UL-thread tension (blue). > Increase LL-thread tension (red).
Needle thread (yellow) forms loops on bottom side of the fabric.	<ul style="list-style-type: none"> > Reduce LL-thread tension (red). > Increase LN-thread tension (yellow).
The fabric edge forms a tunnel or curls.	<ul style="list-style-type: none"> > Reduce UL-thread tension (blue). > Reduce LL-thread tension (red). > Increase the mtc micro thread control. > Reduce the cutting width CW. > Check the rolled hem selection N/R position.
The seam puckers.	<ul style="list-style-type: none"> > Reduce LN-thread tension (yellow). > Set the differential feed between 1 and 0.6 (stretching). > Reduce the stitch length SL.

3-Thread Overlock Narrow (RN)

Stitch Formation	Measures
Looper threads (red/blue) form loops on the bottom side of fabric.	<ul style="list-style-type: none"> > Reduce LL-thread tension (red). > Increase UL-thread tension (blue).
Looper threads (red/blue) form loops on the top side of fabric.	<ul style="list-style-type: none"> > Reduce UL-thread tension (blue). > Increase LL-thread tension (red).
Needle thread (green) forms loops on bottom side of the fabric.	<ul style="list-style-type: none"> > Reduce LL-thread tension (red). > Increase RN-thread tension (green).
The fabric edge forms a tunnel or curls.	<ul style="list-style-type: none"> > Reduce UL-thread tension (blue). > Reduce LL-thread tension (red). > Increase the mtc micro thread control. > Reduce the cutting width CW. > Check the rolled hem selection N/R position.

Stitch Formation	Measures
The seam puckers.	<ul style="list-style-type: none"> > Reduce RN-thread tension (green). > Set the differential feed between 1 and 0.6 (stretching). > Reduce the stitch length SL.

3-Thread Flatlock Wide (LN)

Stitch Formation	Measures
Upper looper thread (blue) extends over the fabric edge towards the bottom.	<ul style="list-style-type: none"> > Reduce LN-thread tension (yellow). > Increase UL-thread tension (blue).
Upper looper thread (blue) doesn't reach the fabric edge.	<ul style="list-style-type: none"> > Reduce UL-thread tension (blue). > Increase LN-thread tension (yellow).
Lower looper thread (red) not straight along the fabric edge.	<ul style="list-style-type: none"> > Increase LL-thread tension (red). > Reduce LN-thread tension (yellow). > Reduce UL-thread tension (blue).
The seam puckers. Lower looper thread (red) too tight.	<ul style="list-style-type: none"> > Reduce LL-thread tension (red).
Needle thread (yellow) doesn't reach the fabric edge.	<ul style="list-style-type: none"> > Reduce LN-thread tension (yellow). > Increase UL-thread tension (blue). > Increase LL-thread tension (red).
Needle thread (yellow) extends over the fabric edge to the top.	<ul style="list-style-type: none"> > Reduce UL-thread tension (blue). > Increase LN-thread tension (yellow).
The fabric edge forms a tunnel or curls.	<ul style="list-style-type: none"> > Reduce LN-thread tension (yellow). > Reduce UL-thread tension (blue). > Increase the mtc micro thread control. > Reduce the cutting width CW. > Check the rolled hem selection N/R position.

3-Thread Flatlock Narrow (RN)

Stitch Formation	Measures
Upper looper thread (blue) extends over the fabric edge towards the bottom.	<ul style="list-style-type: none"> > Reduce RN-thread tension (green). > Increase UL-thread tension (blue).
Upper looper thread (blue) doesn't reach the fabric edge.	<ul style="list-style-type: none"> > Reduce UL-thread tension (blue). > Increase RN-thread tension (green).
Lower looper thread (red) not straight along the fabric edge.	<ul style="list-style-type: none"> > Increase LL-thread tension (red). > Reduce RN-thread tension (green). > Reduce UL-thread tension (blue).

Stitch Formation	Measures
The seam puckers. Lower looper thread (red) too tight.	> Reduce LL-thread tension (red).
Needle thread (green) doesn't reach the fabric edge.	> Reduce RN-thread tension (green). > Increase UL-thread tension (blue). > Increase LL-thread tension (red).
Needle thread (green) extends over the fabric edge to the top.	> Reduce UL-thread tension (blue). > Increase RN-thread tension (green).
The fabric edge forms a tunnel or curls.	> Reduce RN-thread tension (green). > Reduce UL-thread tension (blue). > Increase the mtc micro thread control. > Reduce the cutting width CW. > Check the rolled hem selection N/R position.

3-Thread Narrow Seam

Stitch Formation	Measures
Looper threads (red/blue) form loops on the bottom side of fabric.	> Reduce LL-thread tension (red). > Increase UL-thread tension (blue).
Looper threads (red/blue) form loops on the top side of fabric.	> Reduce UL-thread tension (blue). > Increase LL-thread tension (red).
Needle thread (green) forms loops on bottom side of the fabric.	> Increase RN-thread tension (green).
The fabric edge doesn't curl as intended.	> Increase the cutting width CW. > Increase LL-thread tension (red). > Increase UL-thread tension (blue). > Reduce the stitch length SL. > Check the rolled hem selection N/R position.
The seam puckers.	> Set the differential feed between 1 and 0.6 (stretching). > Reduce RN-thread tension (green). > Reduce the stitch length SL.

3-Thread Rolled Hem

Stitch Formation	Measures
Upper looper thread (blue) wraps fabric edge too loosely.	> Increase UL-thread tension (blue). > Increase the cutting width CW. > Increase the stitch length SL.

Stitch Formation	Measures
The fabric edge doesn't curl as intended.	<ul style="list-style-type: none"> > Increase the cutting width CW. > Increase LL-thread tension (red). > Increase UL-thread tension (blue). > Reduce the stitch length SL. > Check the rolled hem selection N/R position.
Upper looper thread (blue) wraps fabric edge too tightly.	<ul style="list-style-type: none"> > Reduce UL-thread tension (blue). > Reduce the stitch length SL.
Lower looper thread (red) not straight along the needle thread.	<ul style="list-style-type: none"> > Increase LL-thread tension (red). > Increase RN-thread tension (green).
The seam puckers.	<ul style="list-style-type: none"> > Set the differential feed between 1 and 0.6 (stretching). > Reduce LL-thread tension (red). > Reduce RN-thread tension (green). > Reduce the stitch length SL.
Needle thread (green) forms loops on bottom side of the fabric.	<ul style="list-style-type: none"> > Increase RN-thread tension (green).

2-Thread Wrapped Overlock Wide (LN)

Stitch Formation	Measures
Looper thread (red) wraps fabric edge too loosely.	<ul style="list-style-type: none"> > Increase LL-thread tension (red). > Reduce the mtc micro thread control. > Increase the cutting width CW.
Looper thread (red) wraps fabric edge too tightly.	<ul style="list-style-type: none"> > Reduce LL-thread tension (red). > Increase the mtc micro thread control. > Reduce the cutting width CW. > Check the rolled hem selection N/R position.
Needle thread (yellow) forms loops on bottom side of the fabric.	<ul style="list-style-type: none"> > Reduce LL-thread tension (red). > Increase LN-thread tension (yellow).
The fabric edge forms a tunnel or curls.	<ul style="list-style-type: none"> > Reduce LL-thread tension (red). > Increase the mtc micro thread control. > Reduce the cutting width CW. > Check the rolled hem selection N/R position.
The seam puckers.	<ul style="list-style-type: none"> > Reduce LN-thread tension (yellow). > Set the differential feed between 1 and 0.6 (stretching). > Reduce the stitch length SL.

2-Thread Wrapped Overlock Narrow (RN)

Stitch Formation	Measures
Looper thread (red) wraps fabric edge too loosely.	<ul style="list-style-type: none"> > Increase LL-thread tension (red). > Reduce the mtc micro thread control. > Increase the cutting width CW.
Looper thread (red) wraps fabric edge too tightly.	<ul style="list-style-type: none"> > Reduce LL-thread tension (red). > Increase the mtc micro thread control. > Reduce the cutting width CW. > Check the rolled hem selection N/R position.
Needle thread (green) forms loops on bottom side of the fabric.	<ul style="list-style-type: none"> > Reduce LL-thread tension (red). > Increase RN-thread tension (green).
The fabric edge forms a tunnel or curls.	<ul style="list-style-type: none"> > Reduce LL-thread tension (red). > Increase the mtc micro thread control. > Reduce the cutting width CW. > Check the rolled hem selection N/R position.
The seam puckers.	<ul style="list-style-type: none"> > Reduce RN-thread tension (green). > Set the differential feed between 1 and 0.6 (stretching). > Reduce the stitch length SL.

2-Thread Flatlock Wide (LN)

Stitch Formation	Measures
Lower looper thread (red) extends over the fabric edge to the bottom.	<ul style="list-style-type: none"> > Increase LL-thread tension (red). > Reduce LN-thread tension (yellow).
Needle thread (yellow) doesn't reach the fabric edge.	<ul style="list-style-type: none"> > Reduce LN-thread tension (yellow). > Increase LL-thread tension (red).
Lower looper thread (red) doesn't reach the fabric edge.	<ul style="list-style-type: none"> > Reduce LL-thread tension (red). > Increase LN-thread tension (yellow).
Needle thread (yellow) extends over the fabric edge to the top.	<ul style="list-style-type: none"> > Reduce LL-thread tension (red). > Increase LN-thread tension (yellow).
The fabric edge forms a tunnel or curls.	<ul style="list-style-type: none"> > Increase the mtc micro thread control. > Reduce the cutting width CW. > Reduce the stitch length SL. > Check the rolled hem selection N/R position.

2-Thread Flatlock Narrow (RN)

Stitch Formation	Measures
Lower looper thread (red) extends over the fabric edge to the bottom.	<ul style="list-style-type: none"> > Increase LL-thread tension (red). > Reduce RN-thread tension (green).
Needle thread (green) doesn't reach the fabric edge.	<ul style="list-style-type: none"> > Reduce RN-thread tension (green). > Increase LL-thread tension (red).
Lower looper thread (red) doesn't reach the fabric edge.	<ul style="list-style-type: none"> > Reduce LL-thread tension (red). > Increase RN-thread tension (green).
Needle thread (green) extends over the fabric edge to the top.	<ul style="list-style-type: none"> > Reduce LL-thread tension (red). > Increase RN-thread tension (green).
The fabric edge forms a tunnel or curls.	<ul style="list-style-type: none"> > Increase the mtc micro thread control. > Reduce the cutting width CW. > Reduce the stitch length SL. > Check the rolled hem selection N/R position.

2-Thread Rolled Hem

Stitch Formation	Measures
Looper thread (red) wraps fabric edge too loosely.	<ul style="list-style-type: none"> > Increase LL-thread tension (red). > Increase the cutting width CW.
Looper thread (red) wraps fabric edge too tightly.	<ul style="list-style-type: none"> > Reduce LL-thread tension (red). > Reduce the cutting width CW. > Check the rolled hem selection N/R position.
The fabric edge doesn't curl as intended.	<ul style="list-style-type: none"> > Increase the cutting width CW. > Reduce the stitch length SL. > Increase LL-thread tension (red). > Check the rolled hem selection N/R position.
Needle thread (green) forms loops on bottom side of the fabric.	<ul style="list-style-type: none"> > Increase RN-thread tension (green).
The seam puckers.	<ul style="list-style-type: none"> > Set the differential feed between 1 and 0.6 (stretching). > Reduce RN-thread tension (green). > Reduce the stitch length SL.

2-Thread Overlock Wide (LN)

Stitch Formation	Measures
Lower looper thread (red) extends over the fabric edge to the bottom.	<ul style="list-style-type: none"> > Increase LL-thread tension (red). > Reduce LN-thread tension (yellow).

Stitch Formation	Measures
Needle thread (yellow) doesn't reach the fabric edge.	<ul style="list-style-type: none"> > Reduce LN-thread tension (yellow). > Increase LL-thread tension (red).
Lower looper thread (red) doesn't reach the fabric edge.	<ul style="list-style-type: none"> > Reduce LL-thread tension (red). > Increase LN-thread tension (yellow).
Needle thread (yellow) extends over the fabric edge to the top.	<ul style="list-style-type: none"> > Reduce LL-thread tension (red). > Increase LN-thread tension (yellow).
The fabric edge forms a tunnel or curls.	<ul style="list-style-type: none"> > Increase the mtc micro thread control. > Reduce the cutting width CW. > Reduce the stitch length SL. > Check the rolled hem selection N/R position.

2-Thread Overlock Narrow (RN)

Stitch Formation	Measures
Lower looper thread (red) extends over the fabric edge to the bottom.	<ul style="list-style-type: none"> > Increase LL-thread tension (red). > Reduce RN-thread tension (green).
Needle thread (green) doesn't reach the fabric edge.	<ul style="list-style-type: none"> > Reduce RN-thread tension (green). > Increase LL-thread tension (red).
Lower looper thread (red) doesn't reach the fabric edge.	<ul style="list-style-type: none"> > Reduce LL-thread tension (red). > Increase RN-thread tension (green).
Needle thread (green) extends over the fabric edge to the top.	<ul style="list-style-type: none"> > Reduce LL-thread tension (red). > Increase RN-thread tension (green).
The fabric edge forms a tunnel or curls.	<ul style="list-style-type: none"> > Increase the mtc micro thread control. > Reduce the cutting width CW. > Reduce the stitch length SL. > Check the rolled hem selection N/R position.

2-Thread Chainstitch

Stitch Formation	Measures
Needle thread (yellow) forms loops on bottom side of the fabric.	<ul style="list-style-type: none"> > Increase LC-Thread tension (yellow). > Check threading path.
Chain looper (purple) thread visible on top side of fabric.	<ul style="list-style-type: none"> > Reduce LC-Thread tension (yellow).
The seam puckers.	<ul style="list-style-type: none"> > Reduce LC-Thread tension (yellow). > Reduce the CL Thread Tension (purple). > Set the differential feed between 1 and 0.6 (stretching). > Reduce the stitch length SL.

Stitch Formation	Measures
Chain looper (purple) thread loose on the bottom side of fabric.	<ul style="list-style-type: none"> > Increase the CL Thread Tension (purple). > Check threading path.

3-Thread Overlock (LN) + Chainstitch (RC)

Stitch Formation	Measures
Looper threads (red/blue) form loops on the bottom side of fabric.	<ul style="list-style-type: none"> > Reduce LL-thread tension (red). > Increase UL-thread tension (blue).
Looper threads (red/blue) form loops on the top side of fabric.	<ul style="list-style-type: none"> > Reduce UL-thread tension (blue). > Increase LL-thread tension (red).
Needle thread (green) forms loops on bottom side of the fabric.	<ul style="list-style-type: none"> > Reduce LL-thread tension (red). > Increase RN-thread tension (green).
Chainstitch needle thread (yellow) forms loops on the bottom side of the fabric.	<ul style="list-style-type: none"> > Increase RC-Thread tension (yellow). > Reduce the CL Thread Tension (purple). > Reduce the stitch length SL. > Check threading path.
Chain looper (purple) thread loose on the bottom side of fabric.	<ul style="list-style-type: none"> > Increase the CL Thread Tension (purple).
The fabric edge forms a tunnel or curls.	<ul style="list-style-type: none"> > Reduce UL-thread tension (blue). > Reduce LL-thread tension (red). > Increase the mtc micro thread control. > Reduce the cutting width CW. > Check the rolled hem selection N/R position.
The seam puckers.	<ul style="list-style-type: none"> > Reduce RC-Thread tension (yellow). > Reduce LN-Thread tension (green). > Reduce the CL Thread Tension (purple). > Set the differential feed between 1 and 0.6 (stretching). > Reduce the stitch length SL.

3-Thread Overlock (RN) + Chainstitch (RC)

Stitch Formation	Measures
Looper threads (red/blue) form loops on the bottom side of fabric.	<ul style="list-style-type: none"> > Reduce LL-thread tension (red). > Increase UL-thread tension (blue).
Looper threads (red/blue) form loops on the top side of fabric.	<ul style="list-style-type: none"> > Reduce UL-thread tension (blue). > Increase LL-thread tension (red).
Needle thread (green) forms loops on bottom side of the fabric.	<ul style="list-style-type: none"> > Reduce LL-thread tension (red). > Increase RN-thread tension (green).

Stitch Formation	Measures
Chainstitch needle thread (yellow) forms loops on the bottom side of the fabric.	<ul style="list-style-type: none"> > Increase RC-Thread tension (yellow). > Reduce the CL Thread Tension (purple). > Reduce the stitch length SL. > Check threading path.
Chain looper (purple) thread loose on the bottom side of fabric.	<ul style="list-style-type: none"> > Increase the CL Thread Tension (purple).
The fabric edge forms a tunnel or curls.	<ul style="list-style-type: none"> > Reduce UL-thread tension (blue). > Reduce LL-thread tension (red). > Increase the mtc micro thread control. > Reduce the cutting width CW. > Check the rolled hem selection N/R position.
The seam puckers.	<ul style="list-style-type: none"> > Reduce RC-Thread tension (yellow). > Reduce RN-thread tension (green). > Reduce the CL Thread Tension (purple). > Set the differential feed between 1 and 0.6 (stretching). > Reduce the stitch length SL.

2-Thread Overlock (LN) + Chainstitch (RC)

Stitch Formation	Measures
Lower looper thread (red) extends over the fabric edge to the bottom.	<ul style="list-style-type: none"> > Reduce LN-Thread tension (green). > Increase LL-thread tension (red). > Reduce the cutting width CW.
Needle thread (green) doesn't reach the fabric edge.	<ul style="list-style-type: none"> > Reduce LN-Thread tension (green). > Reduce the cutting width CW. > Increase LL-thread tension (red).
Lower looper thread (red) doesn't reach the fabric edge.	<ul style="list-style-type: none"> > Reduce LL-thread tension (red). > Increase LN-Thread tension (green). > Reduce the cutting width CW.
Needle thread (green) extends over the fabric edge to the top.	<ul style="list-style-type: none"> > Reduce LL-thread tension (red). > Increase LN-Thread tension (green). > Reduce the cutting width CW.
Chainstitch needle thread (yellow) forms loops on the bottom side of the fabric.	<ul style="list-style-type: none"> > Increase RC-Thread tension (yellow). > Reduce the CL Thread Tension (purple). > Reduce the stitch length SL. > Check threading path.
Chain looper (purple) thread loose on the bottom side of fabric.	<ul style="list-style-type: none"> > Increase the CL Thread Tension (purple).

Stitch Formation	Measures
The fabric edge forms a tunnel or curls.	<ul style="list-style-type: none"> > Increase the mtc micro thread control. > Reduce the cutting width CW. > Reduce LN-Thread tension (green). > Reduce LL-thread tension (red). > Check the rolled hem selection N/R position. > Check threading path.
The seam puckers.	<ul style="list-style-type: none"> > Reduce RC-Thread tension (yellow). > Reduce the CL Thread Tension (purple). > Set the differential feed between 1 and 0.6 (stretching). > Reduce the stitch length SL.

2-Thread Overlock (RN) + Chainstitch (RC)

Stitch Formation	Measures
Lower looper thread (red) extends over the fabric edge to the bottom.	<ul style="list-style-type: none"> > Reduce RN-thread tension (green). > Increase LL-thread tension (red). > Reduce the cutting width CW.
Needle thread (green) doesn't reach the fabric edge.	<ul style="list-style-type: none"> > Reduce RN-thread tension (green). > Increase LL-thread tension (red). > Reduce the cutting width CW.
Lower looper thread (red) doesn't reach the fabric edge.	<ul style="list-style-type: none"> > Reduce LL-thread tension (red). > Increase RN-thread tension (green). > Reduce the cutting width CW.
Needle thread (green) extends over the fabric edge to the top.	<ul style="list-style-type: none"> > Reduce LL-thread tension (red). > Increase RN-thread tension (green). > Reduce the cutting width CW.
Chainstitch needle thread (yellow) forms loops on the bottom side of the fabric.	<ul style="list-style-type: none"> > Increase RC-Thread tension (yellow).
Chain looper (purple) thread loose on the bottom side of fabric.	<ul style="list-style-type: none"> > Increase the CL Thread Tension (purple).
The fabric edge forms a tunnel or curls.	<ul style="list-style-type: none"> > Increase the mtc micro thread control. > Reduce the cutting width CW. > Reduce RN-thread tension (green). > Reduce LL-thread tension (red). > Check the rolled hem selection N/R position. > Check threading path.
The seam puckers.	<ul style="list-style-type: none"> > Reduce RC-Thread tension (yellow). > Reduce the CL Thread Tension (purple). > Set the differential feed between 1 and 0.6 (stretching). > Reduce the stitch length SL.

4-Thread Coverstitch

Stitch Formation	Measures
Needle thread (yellow, green or blue) forms loops on bottom side of the fabric.	<ul style="list-style-type: none"> > Increase the needle thread tension (yellow, green or blue). > Reduce the CL Thread Tension (purple). > Increase the stitch length SL. > Check threading path.
Chain looper (purple) thread loose on the bottom side of fabric.	<ul style="list-style-type: none"> > Increase the CL Thread Tension (purple). > Increase the stitch length SL. > Check threading path.
Chain looper (purple) thread too tense, seam is tunneling.	<ul style="list-style-type: none"> > Reduce the CL Thread Tension (purple). > Reduce the stitch length SL. > Check threading path.
The seam puckers. Needle thread (yellow, green or blue) too tense.	<ul style="list-style-type: none"> > Reduce the needle thread tension (yellow, green or blue). > Set the differential feed between 1 and 0.6 (stretching). > Reduce the stitch length SL.

3-Thread Coverstitch Wide (LC-RC)

Stitch Formation	Measures
Needle thread (yellow or blue) forms loops on bottom side of the fabric.	<ul style="list-style-type: none"> > Reduce the CL Thread Tension (purple). > Increase the stitch length SL. > Check threading path.
Chain looper (purple) thread loose on the bottom side of fabric.	<ul style="list-style-type: none"> > Increase the CL Thread Tension (purple). > Increase the stitch length SL. > Check threading path.
Chain looper (purple) thread too tense, seam is tunneling.	<ul style="list-style-type: none"> > Reduce the CL Thread Tension (purple). > Reduce the stitch length SL. > Check threading path.
The seam puckers. Needle thread (yellow or blue) too tense.	<ul style="list-style-type: none"> > Set the differential feed between 1 and 0.6 (stretching). > Reduce the stitch length SL.

3-Thread Coverstitch Narrow (LC-CC)

Stitch Formation	Measures
Needle thread (yellow or green) forms loops on bottom side of the fabric.	<ul style="list-style-type: none"> > Reduce the CL Thread Tension (purple). > Increase the stitch length SL. > Check threading path.
Chain looper (purple) thread loose on the bottom side of fabric.	<ul style="list-style-type: none"> > Increase the CL Thread Tension (purple). > Increase the stitch length SL. > Check threading path.

Stitch Formation	Measures
Chain looper (purple) thread too tense, seam is tunneling.	<ul style="list-style-type: none"> > Reduce the CL Thread Tension (purple). > Reduce the stitch length SL. > Check threading path.
The seam puckers. Needle thread (yellow or green) too tense.	<ul style="list-style-type: none"> > Set the differential feed between 1 and 0.6 (stretching). > Reduce the stitch length SL.

3-Thread Coverstitch Narrow (CC-RC)

Stitch Formation	Measures
Needle thread (green or blue) forms loops on bottom side of the fabric.	<ul style="list-style-type: none"> > Reduce the CL Thread Tension (purple). > Increase the stitch length SL. > Check threading path.
Chain looper (purple) thread loose on the bottom side of fabric.	<ul style="list-style-type: none"> > Increase the CL Thread Tension (purple). > Increase the stitch length SL. > Check threading path.
Chain looper (purple) thread too tense, seam is tunneling.	<ul style="list-style-type: none"> > Reduce the CL Thread Tension (purple). > Reduce the stitch length SL. > Check threading path.
The seam puckers. Needle thread (green or blue) too tense.	<ul style="list-style-type: none"> > Set the differential feed between 1 and 0.6 (stretching). > Reduce the stitch length SL.

3-Thread Picotstitch

Stitch Formation	Measures
Upper looper thread (blue) wraps fabric edge too loosely.	<ul style="list-style-type: none"> > Increase UL-thread tension (blue). > Increase the cutting width CW. > Reduce the stitch length SL.
The fabric edge doesn't curl as intended.	<ul style="list-style-type: none"> > Increase the cutting width CW. > Increase UL-thread tension (blue). > Reduce the stitch length SL. > Check the rolled hem selection N/R position.
Upper looper thread (blue) wraps fabric edge too tightly.	<ul style="list-style-type: none"> > Reduce UL-thread tension (blue). > Reduce the stitch length SL.
Lower looper thread (red) not straight along the needle thread.	<ul style="list-style-type: none"> > Increase LL-thread tension (red). > Increase RN-thread tension (green).
The seam puckers.	<ul style="list-style-type: none"> > Set the differential feed between 1 and 0.6 (stretching). > Reduce LL-thread tension (red). > Reduce RN-thread tension (green). > Reduce the stitch length SL.

Stitch Formation	Measures
Needle thread (green) forms loops on bottom side of the fabric.	> Increase RN-thread tension (green).

9 Practical Overlocking

In this chapter the most important applications for a successful sewing project are described. More advanced sewing techniques are described in the BERNINA overlocker manual and can be purchased from authorized BERNINA dealers.

9.1 Securing Overlock Stitches

Securing stitches is particularly important when seam ends are not secured by other seams or hems. The stitches are secured when they are overstepped.

Sewing in the Overlock Chain at the Start of the Seam

- > Form a thread chain at a length of 5 - 8 cm.
- > Place the fabric under the presser foot and sew a stitch into the fabric.
- > Lower the needle.
- > Raise the presser foot.
- > Now pull the thread chain carefully forward and place it on the seam line to be sewn.
- > Lower the presser foot.
- > Sew approx. 4 cm over the thread chain.



Sewing in the Overlock Chain at the End of the Seam

- > At the end of the seam, sew one stitch over the fabric edge.
- > Raise the needle.
- > Raise the presser foot.
- > Pull the fabric a bit backwards.
- > Turn the fabric so that the wrong side points upwards.
- > Place the fabric beneath the presser foot so that the needles pierce the fabric at the first stitch.
- > Lower the presser foot.
- > Sew approx. 1.5 - 2.5 cm over the thread chain and make sure that the existing thread chain is not cut.
- > Finish the seam by sewing off the edge.



Securing Overlock Stitches

- > Sew a thread chain of about 10 cm beyond the end of the seam.
- > Pull the thread chain end through the looper threads using a loop flip or a tapestry needle.



Knotting the Overlock chain

Knotting the overlock chain is the safest way to prevent the stitch from opening.

- > Tie thread chain at the seam end, close to the fabric.

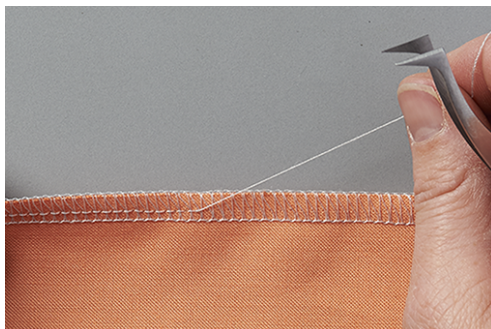
9.2 Removing a Stitch

The thread loops of the looper and needle threads can be undone easily.

- > Pull the right overlock needle thread (RN) out of the thread chain with tweezers, starting from the seam end.



- > Pull the needle thread out of the seam.



- > With very long seams, cut the thread in the stitch and remove it step by step.

- > Remove the left overlock needle thread in the same way.
 - The looper threads lie loosely around the fabric edge and can be pulled away easily.



9.3 Securing Coverstitches

Securing stitches is particularly important when seam ends are not secured by other seams or hems. The stitches are secured when they are over stitched.

Securing Cover- and Chainstitches at the Start of the Seam

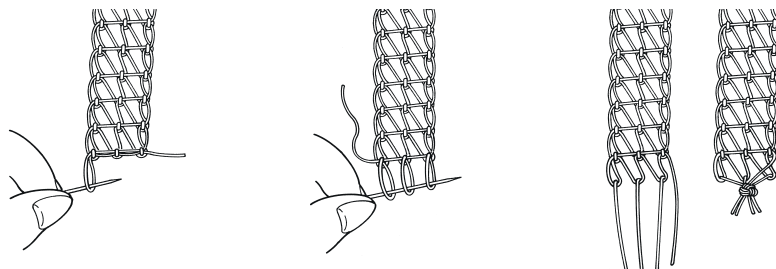
With cover- and chainstitches, the first stitch is automatically secured by the following stitches.

Securing Cover- and Chainstitches at the Seam End

The stitches are secured when they are over stitched. Securing stitches is particularly important when they don't start or end together with other seams or hems.

Securing Coverstitches at the Seam End

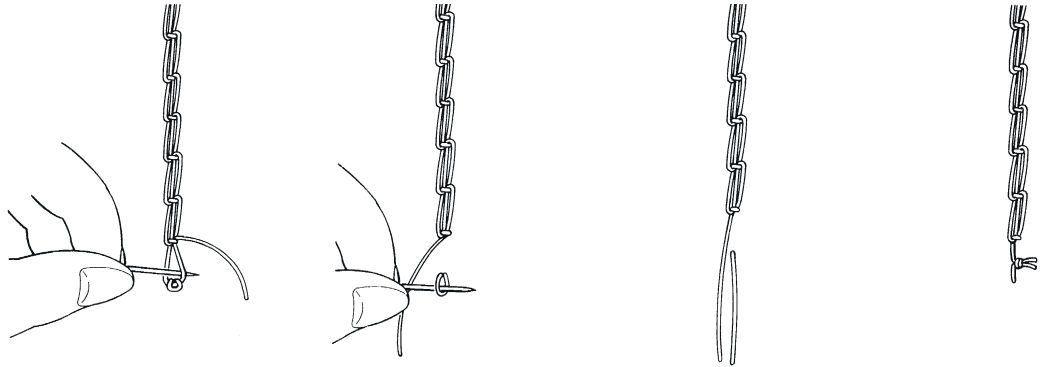
To secure the coverstitch at the end of the seam, the needle threads need to be pulled through the loop of the looper thread first and then knotted with the end of the looper thread on the wrong side of the fabric.



- > Turn the fabric to the wrong side.
- > Undo the loop of the looper thread with a sewing needle and hold it.
- > Pull the looper thread ends upwards so that the loops of the needle thread appear on the wrong side of the fabric.
- > String the loops of the needle threads with a sewing needle and pull them up so that all thread ends are on the wrong side of the sewing project.
- > Knot all thread ends together close to the stitch end.

Securing Chainstitches at Seam End:

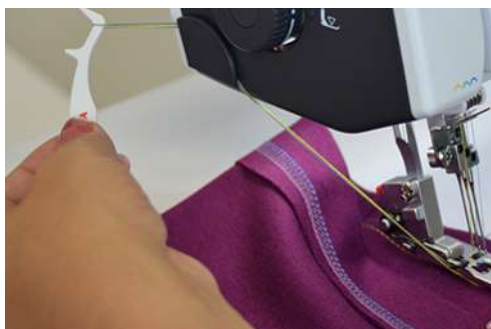
To secure the chainstitch at the end of the seam, the needle thread need to be pulled through the loop of the looper thread first and then knotted with the end of the looper thread on the wrong side of the fabric.



- > Turn the fabric to the wrong side.
- > Undo the loop of the looper thread with a sewing needle and hold it.
- > Pull the end of the looper thread upwards so that the loops of the needle thread appear on the wrong side of the fabric.
- > String the loops of the needle threads with a sewing needle and pull them up so that all thread ends are on the wrong side of the sewing project.
- > Knot all thread ends together close to the stitch end.

Securing the Stitches at the Seam End and Detaching the Thread Chain

- > Sew the hem or the seam. When sewing in a circle, sew the last stitches over the first stitches.
- > Raise the needles and the presser foot.
- > Pull the needle threads between the presser foot and the fabric to the back with the CS Lock Tool and cut them.



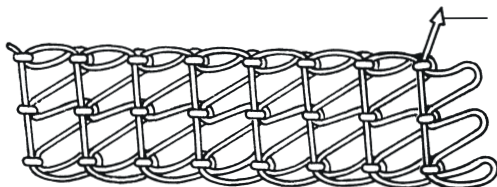
- > Pull the fabric to the back and cut the looper threads.
 - The coverstitches and chainstitches are secured.
 - The overlock stitches are secured and the thread chain is detached.

9.4 How to Undo Coverstitches

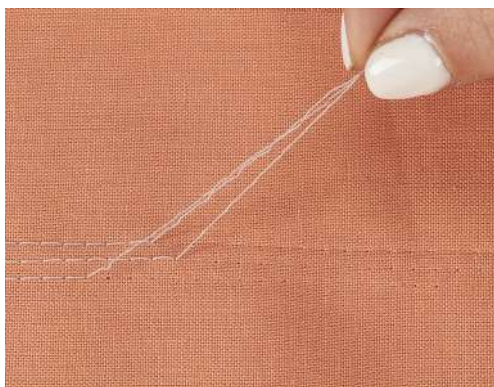
Cover- and chainstitches are loops which are formed by the intertwining of looper thread and needle threads.

Undoing Coverstitches

- > On the wrong side of the fabric, pull the looper thread out of the thread chain at the seam end.

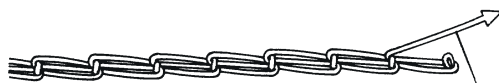


- > Remove the needle thread on the right side of the fabric.
 - The stitches are undone.



Undoing Chainstitches

- > At the end of the seam, pull the looper thread out of the thread chain on the wrong side.



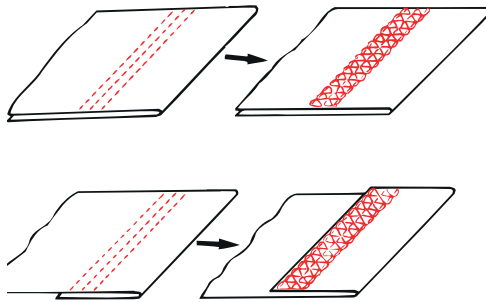
- > Remove the needle thread on the right side of the fabric.
 - The stitches are undone.

9.5 Sewing a Hem

The coverstitch is ideal for hems on elastic and knitted material.

- > Set the machine for the coverstitch.
- > Mark the hem depth (wrong side on wrong side) and press the hem.
- > Place the fabric under the presser foot, right side up.

- > Guide the edge of the hem along one of the markings on the coverstitch insert and sew.
 - The hem is sewn and finished on the wrong side at the same time.



- > Cut back any excess seam allowance.

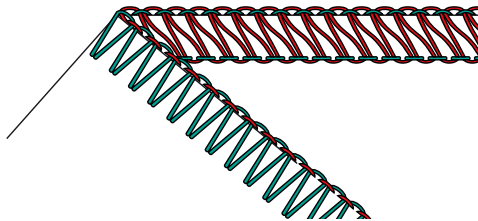
9.6 Flatlock

The flatlock forms loops on the upper side of the seam and stretch stitches on the underside.

- > Set the machine for a 2- or 3-thread flatlock.
- > Sew two layers of fabric together (wrong side on wrong side).
- > Carefully separate the two layers of fabric.
 - The two fabric edges now lie flat on top of each other at the stitch width of the flatlock.

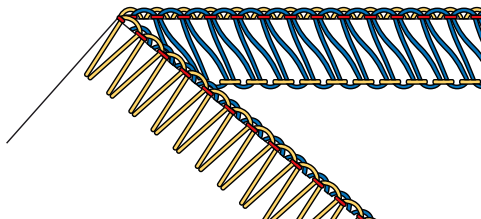
Flatlock Narrow

A narrow flatlock is the result when the Right Overlock Needle (RN) is inserted.



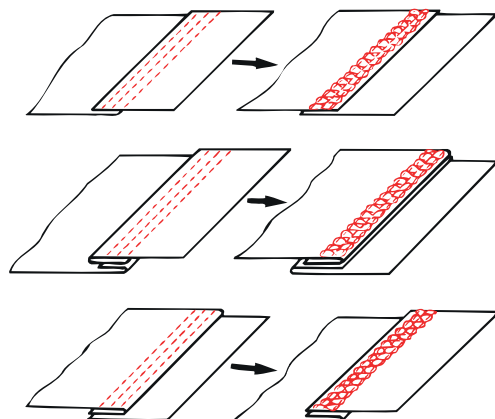
Flatlock Wide

A wide flatlock is the result when the Left Overlock Needle (LN) is inserted.



9.7 Joining Seams

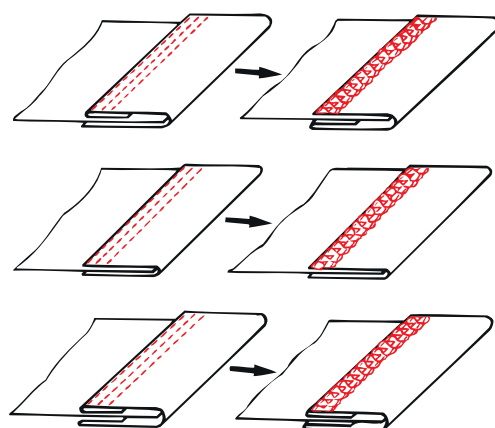
- > Thread and set the machine for a cover- or chainstitch.
- > Adjust the stitch length to be suitable for the fabric.
- > Place the fabric under the presser foot and lower the presser foot.
- > Sew the seam.
- > To sew parallel lines or pintucks, use either the left or the right edge of the foot or the scale on the coverstitch insert.



9.8 Binding Seams

Seam binding proves ideal for elastic necklines, sleeve edgings and circular finishes.

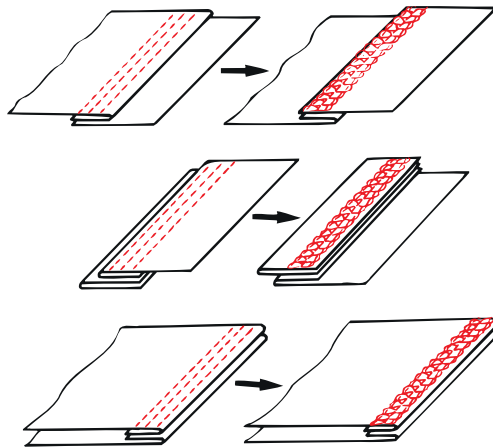
- > Cut the bias tape or tricot strips to size at the desired width.
- > Mark the seam, pre-iron or pin it.
- > Place the binding around the edge of the fabric and start sewing.
- > Guide the edge of the binding on the upper side of the sewing project along the left spring-loaded foot part.
 - On the bottom side, the edge of the binding is finished by the looper thread.
- > Trim the protruding seam allowance to 2 mm.



9.9 Topstitching Seams

To topstitch overlock seams, the coverstitch is suitable in all elastic materials. Ideal for sweatshirts, jersey dresses, jackets, knitted coats and patchworked garments.

- > Place the seam to one side or iron it.
- > Topstitch close along the edge on the right of the sewing project.
- > Guide the lateral foot parts along the edge of the seam.
 - A decorative, hard-wearing and durable finish is created.



9.10 Gathering

Ruffling is a gathering or puckering of a seam.

Pulling the Needle Thread

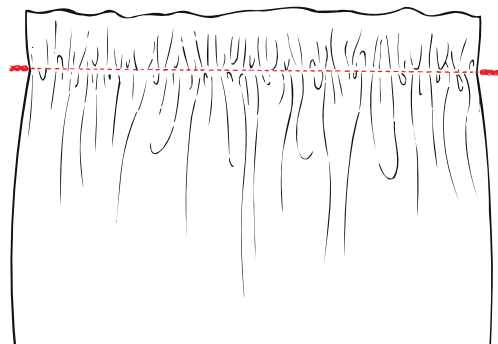
- > Set the machine for a 4-Thread Overlock.
- > Set the differential feed at default value.
- > Sew the fabric with this side up on which the ruffling is wanted.
- > Leave a long thread chain at seam end.
- > Separate the needle thread/threads from the thread chain.
- > Pull the needle thread(s) and evenly spread the puckers along the seam.



9.11 Gathering a Seam

Single layers of thin fabric can be gathered with the chainstitch.

- > Increase differential feed



9.12 Sew Outer Corners

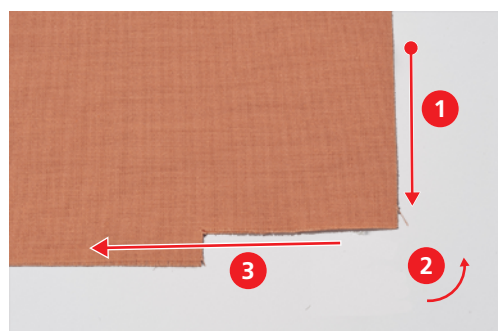
How to Sew over a Corner

- > Set the machine for a 2-, 3- or 4-Thread Overlock.
- > Sew along the edge of the fabric beyond the corner.
- > Start a new edge and sew over the previously sewn edge.
- > Secure the thread chain. (see page 92)



How to Clip a Corner

- > Trim the seam allowance for the cutting width of the following corner in the sewing direction (presser foot length).



- > First sew the edge up to the cut corner.
- > Sew one stitch beyond the fabric edge and stop.
 - The needles are in the top position.
- > Raise the presser foot.

- > Move the rolled hem selection lever to position «R».
 - The thread loops are loosened from the stitch finger.
- > Turn the fabric counterclockwise.
 - The trimmed edge of the fabric is in the sewing direction under the presser foot.
- > Move the rolled hem selection lever to position «O».
- > Pierce the needle into the fabric.
- > Pull back and tighten loose threads of the thread spools on the spool holder.
- > Lower the presser foot and continue sewing.



9.13 Sewing Inner Corners

- > Set the machine for a 2- or 3-Thread Overlock.



- > Draw sewing lines on both sides of the corner about 5 cm long with the fabric pen.
- > Sew the seam until the knife reaches the corner.
- > Place the needle in the fabric.
- > Raise the presser foot.
- > Carefully pull the fabric edge to a straight line and fold the fabric forwards.
- > Lower the presser foot.
- > Continue sewing until the needles reach the corner.
- > Hold the fabric in place by stitching the needles in the inside corner.
- > Raise the presser foot and fold the fabric to the back.
- > Lower the presser foot and continue sewing.

9.14 Sewing Inner Curves

Inner curves appear on necklines, facings and armholes. Time-consuming clipping or trimming can be avoided by overlocking the fabric edge.

- > Set the machine for a 3- or 4-Thread Overlock.

- > While sewing, stretch the curve carefully so it is straight.



9.15 Sew Outer Curves and Circles

- > Cut away the seam allowance in one place along the length of the presser foot.



- > Start and end the seam at the cut seam allowance.
 - if seam waving out happens: set the differential feed to 1,5 – 2.
 - if puckering happens: set the differential feed to 0.7 – 1.
- > At the seam end, sew 1 – 2 stitches over the seam beginning.
- > Lower the needle and raise the presser foot.
- > Turn the fabric off to the left of the presser foot.



- > Lower the presser foot and sew over and beyond the fabric.

10 Appendix

10.1 Storing and Transporting the Machine

Storing the Machine

The correct storage of the machine over a longer period of time has an influence on its lifespan and functionality.

- > Don't store the machine outdoors.
- > Protect the machine against climatic influences.
- > Before operating the machine again after storage, leave the machine unpacked for approx. 1 h at room temperature.

Transporting the Machine

For a relocation or a longer transport of the machine, the following actions should be carried out.

- > Retract the retractable thread guide of the spool holder completely downwards.
- > Lower the presser foot.
- > Remove all connecting cables.
- > Lift and transport the machine at the carry handle.

10.2 Maintenance and Cleaning the Machine

NOTICE

Damage by Cleaning with Compressed Air

Cleaning using aerosol sprays or compressed air may cause permanent damage to your machine. A repair by the authorized bernette dealer is required.

- > Remove fabric scraps and thread remnants using a vacuum cleaner with soft tip.

Cleaning the Machine

The service life of the machine depends on the care and maintenance. Based on normal household use, an annual service at the authorized bernette dealer is recommended.

Recommended aids:

- Damp Cloth
- Brush
- Tweezers
- Vacuum Cleaner with Soft Tip

Clean recommended machine areas:

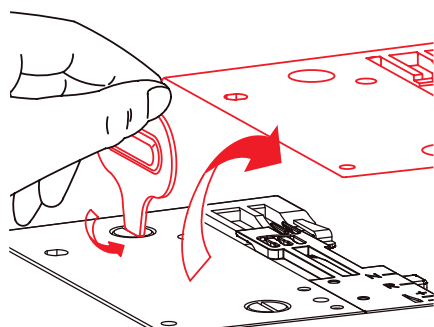
- Needle, Needle Bar
 - Presser Foot
 - Feed Dog (from above)
 - Knife
 - Freearm Interior
- > The machine can be cleaned with a damp cloth without detergent.
 - > Regularly free the recommended areas from dust, fabric scraps and thread remnants.

Cleaning the Looper Area

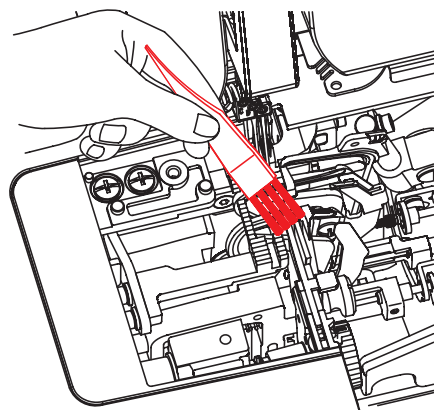
Dust, fabric and thread remnants accumulate in the looper area during coverstitching. They should be removed regularly.

Prerequisite:

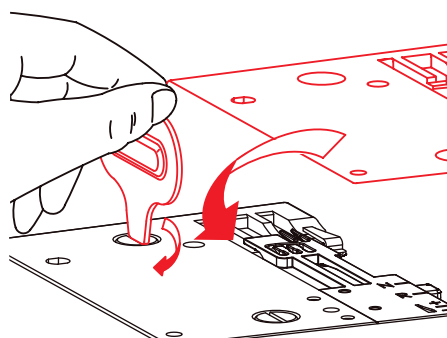
- The presser foot is raised.
 - The needles are in the top position.
 - The machine is switched off.
- > Remove the presser foot.
- > Unscrew the stitch plate from the freearm.



- > Remove dust, fabric and thread remnants with the brush or a vacuum cleaner.



- > Attach the stitch plate and screw it on.



- > By slowly turning the handwheel, ensure that the knife, the needle and the feed dogs are not impeded in their movement.
- > Attach the presser foot.

Cleaning the Air Threader Pipes

Regularly remove dust and thread remnants from the air threader pipes.

- > Use a thick thread (e.g. Amann Saba C size 30) at a length of about 1 m.
- > Feed the thread into the air threader nozzle.
- > Hold the thread at the thread ends and pull it back and forth several times.
- > Remove the thread at the looper end in the thread feed direction.

Cleaning the Suction Feet

Cleaning the suction feet prevents the machine from slipping on the table at high sewing speed.

- > Remove dust and thread remnants from the suction feet with a damp cloth.

Oiling the Machine

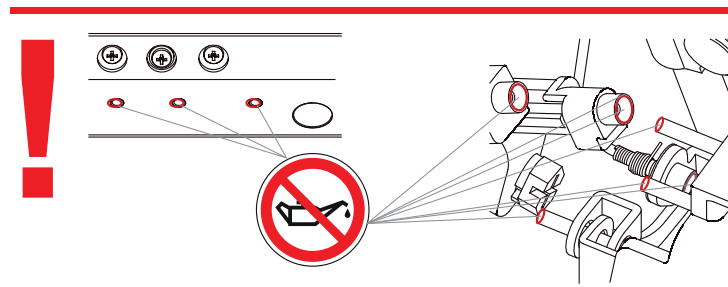
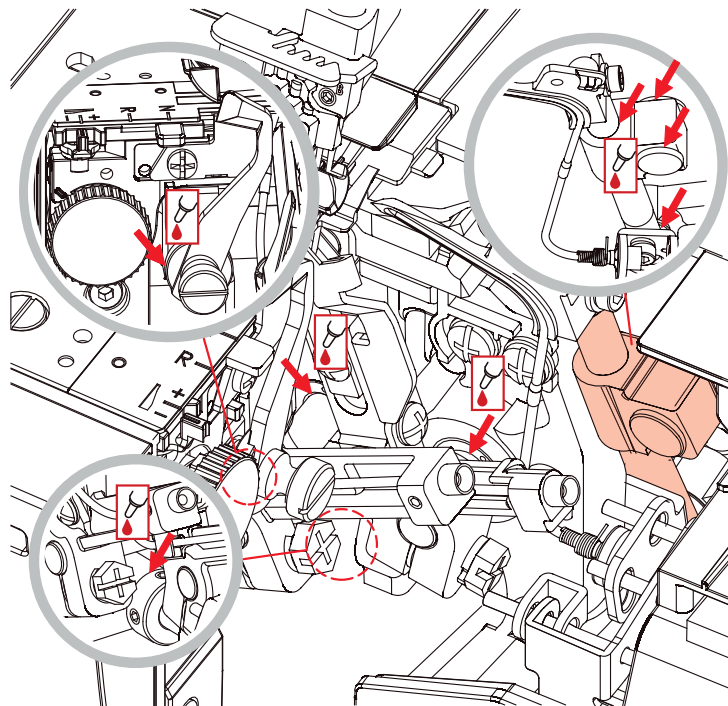
NOTICE

Damage by Fluids in the Air Threader System

The air threader pump may be damaged permanently if liquids infiltrate the system. A repair by the authorized bernette dealer is required.

- > Keep liquids away from the air threader nozzles.

- > Regularly lubricate recommended areas with a drop of the supplied bernette.



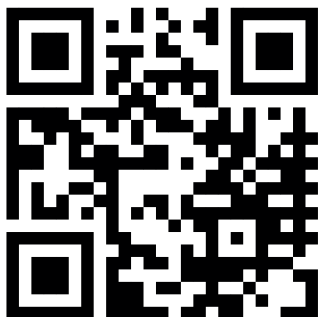
10.3 Troubleshooting

Fault	Solution
Fabric does not feed well.	<ul style="list-style-type: none"> > Elongate the stitch length. > Increase the presser foot pressure for heavyweight fabric. > Decrease the presser foot pressure for lightweight fabrics. > Check the setting of the differential feed.
Needle breaks	<ul style="list-style-type: none"> > Insert the needle correctly. > Don't pull the fabric while sewing. > Tighten the needle screw. > Use a stronger needle for heavyweight fabrics.
Thread breakage	<ul style="list-style-type: none"> > Loosen the thread tension. > Check the thread path. > Check for tangled or caught thread. > Insert the needle correctly. > Insert new needles; the inserted needles may be defective. > Use high-quality thread.
Skipped stitches	<ul style="list-style-type: none"> > Insert new needles; the inserted needles may be defective. > Tighten the needle screw. > Match the needle size with the fabric/thread. > Insert the needles correctly. > Change type or size of the needle. > Check the thread path. > Increase the presser foot pressure. > Adjust the thread tension. > Use high-quality thread.
Irregular stitches	<ul style="list-style-type: none"> > Adjust the thread tension. > Check for tangled or caught thread. > Check the thread path.
Fabric puckers	<ul style="list-style-type: none"> > Check the setting of the differential feed. > Loosen the thread tension. > Check for tangled or caught thread. > Use high-quality thread. > Shorten the stitch length. > Decrease the presser foot pressure for lightweight fabrics.
Irregular trimming	<ul style="list-style-type: none"> > Check the alignment of the knives. > Replace one or both knives.
Fabric jam	<ul style="list-style-type: none"> > Decrease the presser foot pressure. > Check the setting of the differential feed. > Check for tangled or caught thread. > Baste thick layers of fabric first with a conventional sewing machine before sewing it with the overlocker.
The fabric is not cut properly	<ul style="list-style-type: none"> > Set the cutting width to 9. > Remove lint and remnants from the knife.

Fault	Solution
Knife defective	> Replace the knife.
Machine not running	> Connect machine to the power source and switch it on. > Close the looper cover.

10.4 Technical Specifications

Name	Value	Unit
Number of stitches	31	
Number of loopers	3	
Number of needles	1– 5	
Needle system	ELx705	
Needle size	80 – 100 (12 – 16)	
Differential feed	0.6 – 2.0	
Maximum fabric thickness	5 (0,23)	mm (in)
Cutting width overlock LN	5.0 – 7.0 (0.19 – 0.27)	mm (in)
Cutting width overlock RN	3.0 – 5.0 (0.12 – 0.19)	mm (in)
Stitch width coverstitches	2.8 – 5.6 (0.11 – 0.22)	mm (in)
Stitch width combostitches	7.8 – 12.6 (0.31 – 0.49)	mm (in)
Maximum sewing speed	1300	Stitches per minute
Dimensions without retractable thread guide (LxWxH)	43 x 27 x 29 (16.92 x 10.62 x 11.41)	cm (in)
Dimensions with slide-on table / cut-offs bin (LxWxH)	59 x 40 x 29 (23.22 x 15.78 x 11.41)	cm (in)
Weight of the machine	8.9 (19.6)	kg (lb)
Weight packaged	12.8 (28.2)	kg (lb)
Input voltage (energy consumption)	120 (80) / 230 – 240 (75)	V (W)
Protection class (Electrical Engineering)	II	
Date of manufacture	Visible on the type plate	



www.bernette.com/b68AIRLOCK

2023-06 EN
50400685.00A.04

© BERNINA International AG
Steckborn CH, www.bernina.com