

Technique Sheet for Sidekick & High/Low Left Handed Diagrams

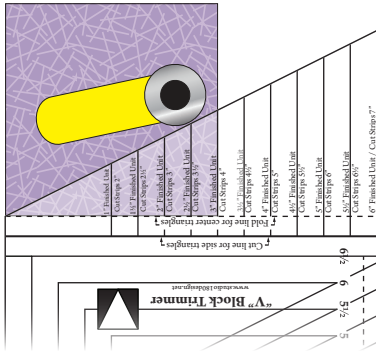

Cut the base sections

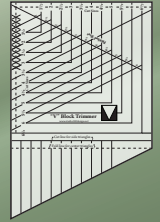
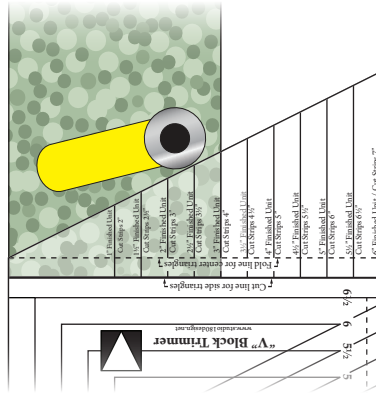

Cut the side triangles

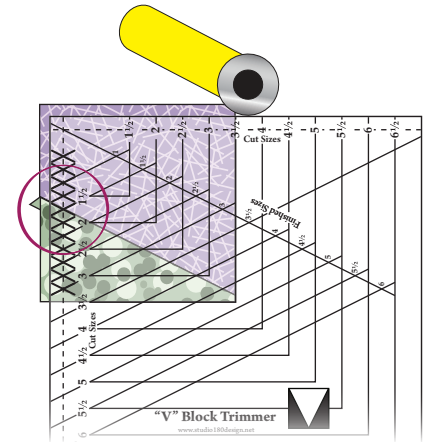
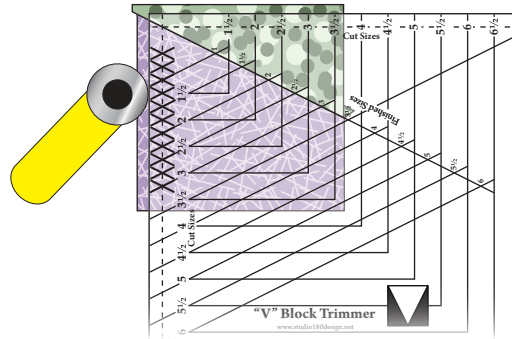

Step 2 & 3 - Trim and then Rotate

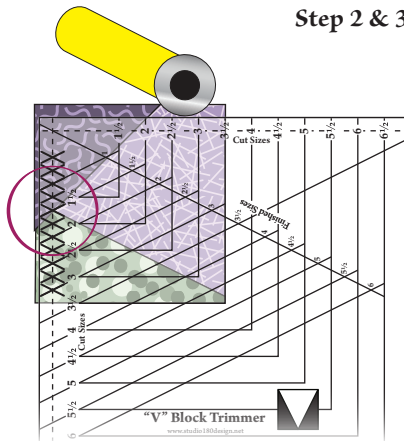
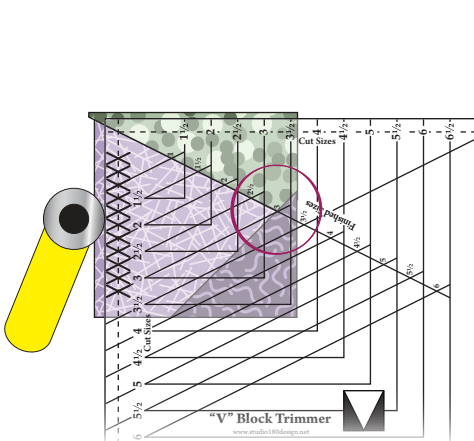

Step 4 & 5 - Trim, Rotate then Trim again