



Cutting

Each block will require two star strips and two background strips.

You can use the same or different fabrics for the two star strips. If they are the same, the star will be that color, if they are different, your star points will alternate. You can also use one or two background fabrics as well.

You will see several measurements listed — Strip Width for the star points, Strip Width for the background triangles, Strip Length for one block, and Number of Cuts per width of fabric.

Note that the Strip Length column lists the shortest length of the strip pairs needed to make one complete block. The length is the same for both the star strips and the background strips.

The Number of Cuts column lists the approximate number of 45° cross cuts that can be made from

one full width fabric strip. This number may vary depending on the width of your chosen fabric.

You can use these measurements/numbers to determine how much yardage you will need for future projects.

Please read through all instructions prior to starting your first project.

Finished Block Size	Cut Size of Star Strips	Cut Size of Background Strips	Minimum Strip Length for One Block	Approx. # of Diagonal Cuts from Full Fabric Width
3"	1¼"	2½"	10"	18 to 20
4"	1½"	2¾"	13"	16 to 18
5"	1¾"	3"	14"	15 to 16
6"	2"	3¼"	16"	14
7"	2¼"	3½"	17"	12
8"	2⅝" or 2½"	3¾"	18"	11
9"	2½"	4"	20"	11
10"	2¾"	4¼"	21"	10
11"	3"	4½"	23"	9
12"	3¼"	4¾"	24"	8

Construction

Step 1 - Mark. Place the two background strips right sides up, laying side by side, see diagram. On the top of the strip on the left use a pencil or marker and write “A - top”, on the strip on the right mark “B - top”. You will make two additional marks down from the top of the strips on the adjacent, inside edges of the two strips. These marks will be down the same distance that the strip is wide. For example, if you are using 2¾” background strips, you will make a mark down from the top at the 2¾” measurement. If your strip is 3” wide, mark down 3”. These marks will note the starting point for placement of your star strips.

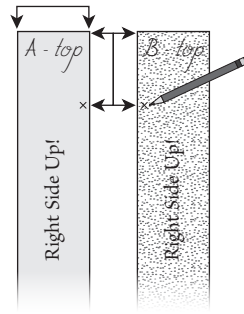

Step 1 Diagram - Mark

Step 2 - Position a star strip right sides together with each of the background strips. The ends of the star strips will be placed at the marks made in step 1 so that the top edges are staggered. See the diagram.

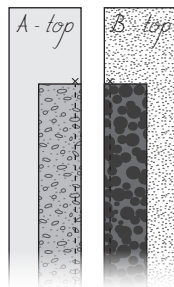

Step 2 & 3 Diagram - Position & Stitch

Step 3 - Stitch the strips using a ¼” seam.

Step 4 - Press. To determine pressing direction follow these steps: place background strip right side facing up with the “A” pair on the left and the “B” pair on the right. Make sure you can read “A top” and “B top” as shown in diagram. The “A” pair should have seams pressed toward the background fabric. The “B” pair should have seams pressed toward the star fabric. See the pressing arrows in the illustration.

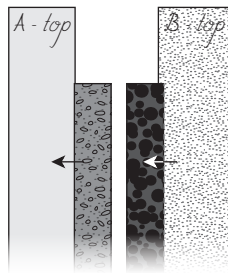

Step 4 Diagram - Pressing

Step 5 - Position. Move the strips to the cutting mat and layer the strip pairs right sides together, background strip to background strip and star strip to star strip. The long seams should “nest”. Note that if you are right handed, you will want to place the “A” strip on top and place the end marked “tops” on the left hand side of your

cutting mat. If you are left handed place the “B” strip on top and the end marked “tops” on the right hand side of your cutting mat. See diagram. In both cases the star strip should be closest to your body and the background strip furthest away. Proper positioning here will allow you to easily cut the 45° angled slices.

Step 5 Diagram - Position Strips on Cutting Mat

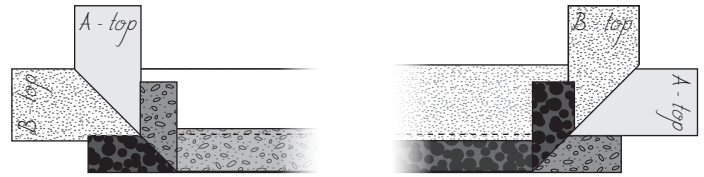

Right Hand Cutting Position

Left Hand Cutting Position

Step 6 - Cut. Make a 45° angled cut. Right handers cut from lower right to upper left. Left handers cut from lower left to upper right. Note: I use my Lemoyne Star ruler to help insure that I get a good 45° angle. The illustration shows its placement. By lining up the ruler edge with the stitching line as shown and bumping another cutting ruler up against the angled edge, I can be sure to get the correct angle right from the start. See diagram.

Step 6 Diagram - Cut a 45° angle

It is important to begin with and to maintain a good 45° angle when cutting the strip pairs. Check it frequently!

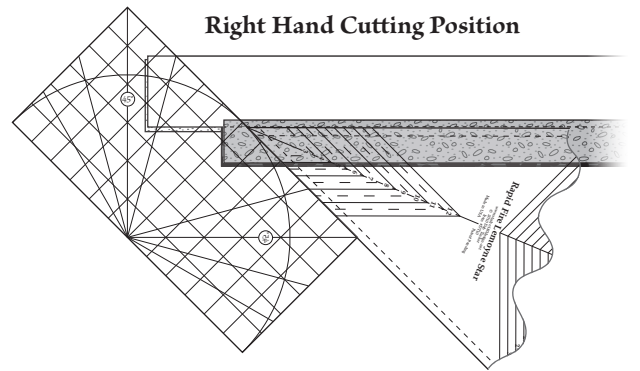

Right Hand Cutting Position

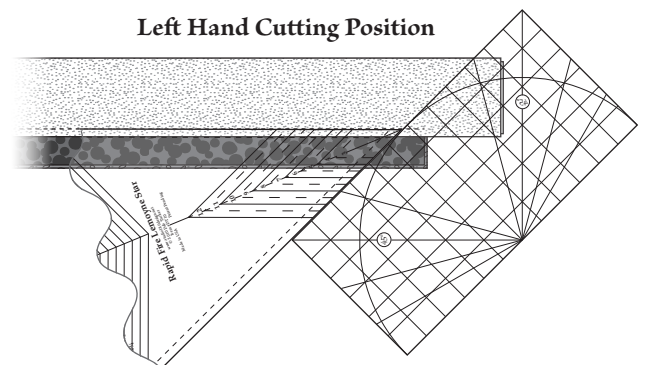

Left Hand Cutting Position

Step 7 - Continue 1st Cuts. Continue making 45° angle cuts along the length of the strip pairs. Each cut should be the same measurement as the Star Strip width. For example, if you are making a 6" block, you'll have cut the star strips 2" wide, so you will need to make your angled cuts 2" apart. Continue until you have either four slices for one block or until you run out of fabric.

Note: It is important to keep the 45° as accurate as possible for best results. Be sure to check your angle after every 4 to 6 cuts. No matter how precise you are, somehow this angle will usually end up slightly skewed.

Once the 45° cuts are made, slightly separate the sections as shown in the diagram. This will help to ensure that the next round of cuts are going in the correct direction.

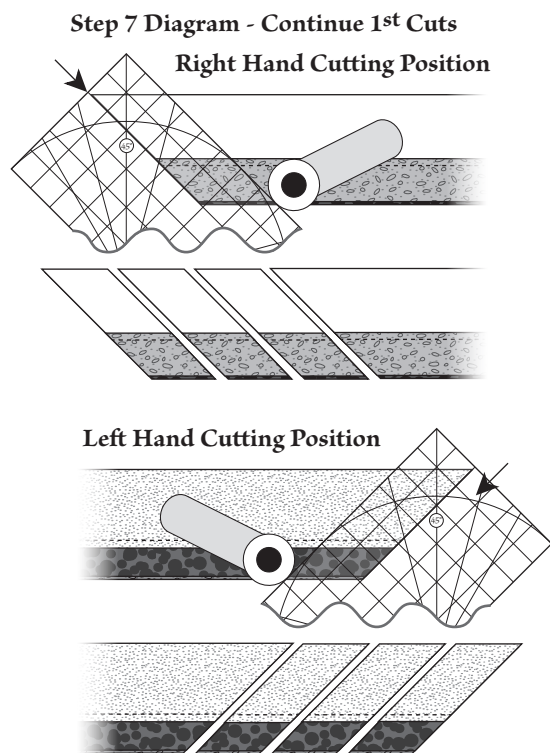

Step 8 - Second Cuts. Make second cuts going vertically south to north. See diagram. Position the ruler edge at the tip of the Star Strip and trim straight up. Important: You will not be measuring anything at this point. You are simply cutting another pair of triangles that will be oversized and that will be added to the pieced unit. Do try to keep your cut going straight up and not skewed.

You should have plenty of fabric. If you chop off the tip of the additional triangle, which sometimes happens with the smaller size blocks, again don't worry. You will still have plenty of fabric!

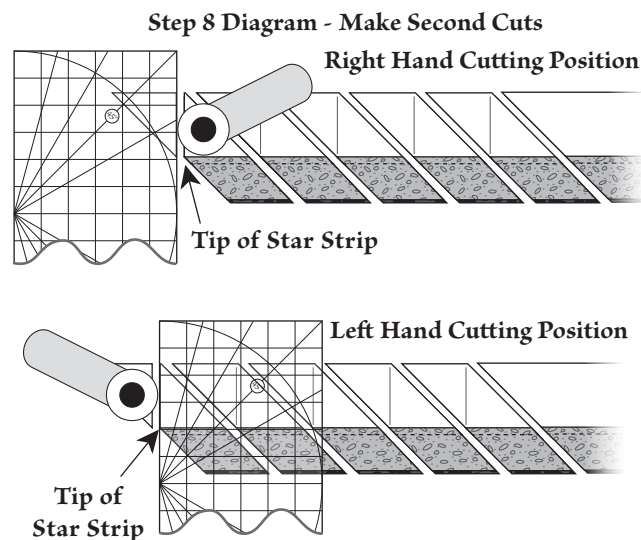

Note: If you are left handed it will be beneficial to flip each of the pairs over from east to west so that they look like the pairs trimmed by right handed cutters. This will allow you to see the tip of the star fabric that is your guide post for the second trim. Examine the left hand trim diagram closely.

Step 9 - Lay Out. Open up the pieced units so they are laying right sides up. Lay the additional triangles that you trimmed in step 8 also right sides up. I generally stack all pieces into groups of 4 in order to have enough to make one block. See diagram.

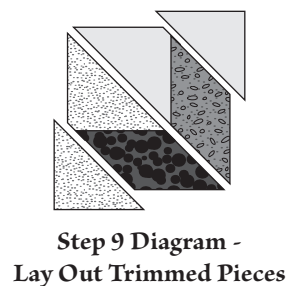

Step 10 - Position & Stitch. Position the additional triangles right sides together with the pieced unit - raw edges even and triangle basically centered over pieced unit. Stitch using a 1/4" seam.

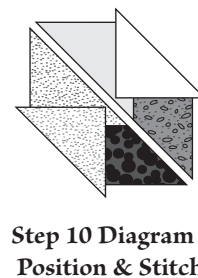

Step 11 - Press Carefully. Press seams as indicated in diagram - "A" pieces will be pressed toward the star point fabric, "B" pieces will be pressed toward the background fabric. Basically these second seams should be pressed to go in the same direction as the previous seams. Proper attention here will result in nesting seams throughout the remainder of the project.

It is easy to get carried away here, but be careful to not head off to sew the diagonals together until they are properly trimmed to the correct size (next step).

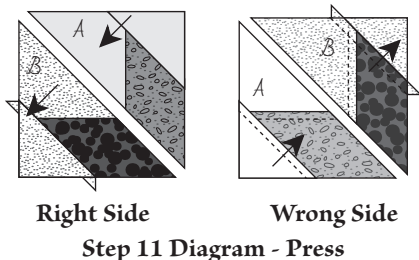

Note: The solid lines on the Rapid Fire® Lemoyne Star tool will indicate lines to be used for making even finished sized blocks - 4", 6", 8", etc. . . . the dashed lines will indicate lines to be used for making odd finished sized blocks - 3", 5", 7", etc. . . .

Step 13 - Examine/Position. You will now have pieced half square triangles that will fit together perfectly in the center and have all seams nesting. For the traditional star you will stitch along the diagonal to create a square. For other designs, you may want to piece two of the short sides together, or possibly stitch a pieced unit to another half square triangle. Remember to think out of the box sometimes!

Step 14 - Stitch. Stitch the pieced triangle units together, first into pairs, then into half blocks and then into the complete block. I prefer to stitch from the star center outward. Use your best 1/4" seams! Focus on aligning the star centers and all pieced seams. See diagram. The outer edges will look uneven. That's because there is extra fabric built into those edges in order to square up your block once it is complete. So don't worry about the outside edges, but do worry about seam alignment and the trimmed raw edge alignment.

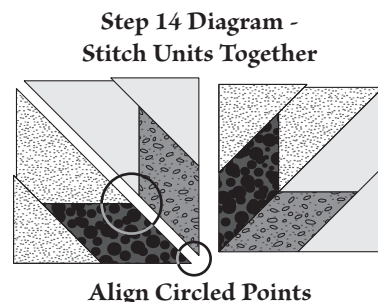

Step 15 - Press. When pressing these seams you have two options. Option #1 is to press all seams open. Option #2 is to press each seam in the same direction as all the other seams in the units. This will result in all seams in the entire block rotating clockwise when looking at the back of the block. To make this happen with the final

Stop before you make another stitch!!

Step 12 - Trim. Take all units to the cutting mat and trim each to an exact size using the Rapid Fire® Lemoyne Star ruler. Place the unit right side up on the mat. Point the diamond toward a 2 o'clock position if you will be trimming right handed or toward a 10 o'clock position if you will be trimming left handed. See diagram. Align the desired block size lines with the sewn seam lines. Trim along both sides of the ruler. I strongly recommend that you use a fresh, sharp blade in your rotary cutter for this step and Invisigrip™ on the back of your ruler. Trim all units.

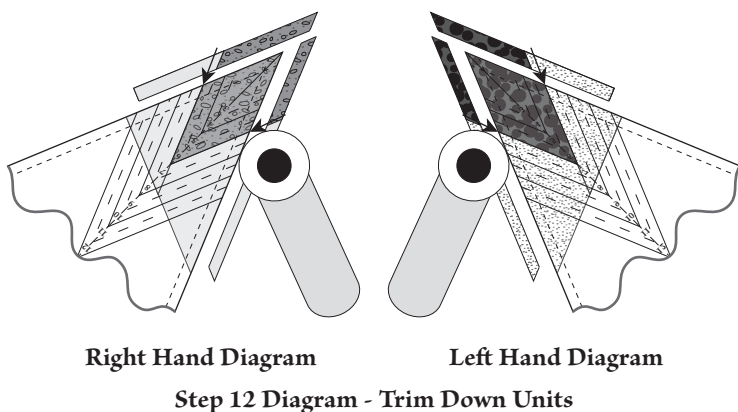

seam, you will need to remove the couple of stitches at the center of the star so that all seams can spin in one direction.

Personally, I choose most often to press my seams open. I find there is less bulk and the seams match up better in the center. Remember that if you do press the seams open, you should not “stitch in the ditch” when quilting. But choose which works best for you. Trim “Dog Ears” at star center.

Step 15 Diagram - Press

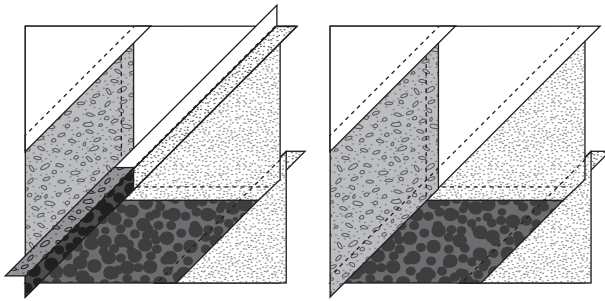

**Option #1 -
Press Seams Open**

**Option #2 -
Press Seam in Same
Direction as Other Seams**

Step 16 - Trim to Size. Once the block is complete, trim to your exact size. I love to use my **Tucker Trimmer™ I** ruler for trimming the Lemoyne Star Blocks 6” or smaller, and my **Tucker Trimmer™ III** ruler for trimming the larger blocks in this step. Remember that each block will need to be trimmed $\frac{1}{2}$ ” larger than the desired finished size, so if you are making a 6” block you will be trimming the block to 6 $\frac{1}{2}$ ” at this step. By using the Tucker Trimmer™, you simply align the desired size

diagonal cross hairs of the ruler with the diagonal seam lines of the pieced block and trim. Rotate the block and repeat for other two sides. The block is immediately centered and all edges will have the correct $\frac{1}{4}$ ” seams. The layout shown is for right handed trimming. If you are trimming left handed, rotate the **Tucker Trimmer™** so that the half circle icon is in the upper left hand corner of the block.

Step 16 Diagram - Trim Block to Size

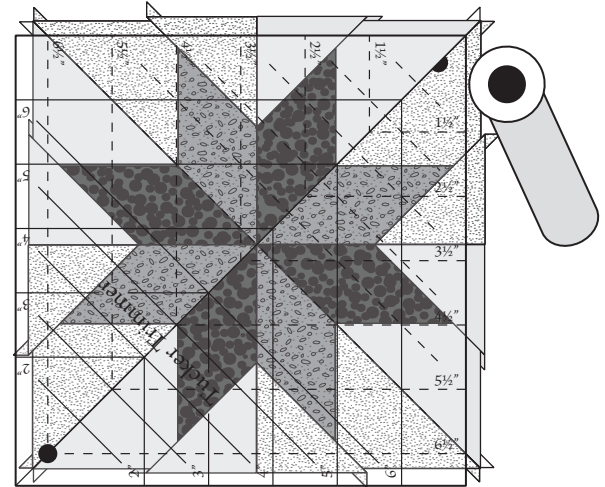

Step 17 - Congratulations! You now have beautiful Lemoyne Star blocks to use in your next quilt project. Be sure to visit your local quilt shop or our website - **Studio180Design.net** - for companion patterns that I’ve designed using the Rapid Fire® Lemoyne Star. While there you may also want to visit our links page to see my free video demonstrations with my other tools and techniques. Enjoy!

But What About the Other End?

On the blunt end of the Rapid Fire® Lemoyne Star template you’ll notice that there are a number of diamond shapes laid sideways ranging in size from $1\frac{1}{4}$ ” to $3\frac{1}{4}$ ”. These diamond shapes can be used to “fussy cut” diamonds one at a time. Once the diamond shapes are cut, you can proceed to add oversized half square triangles to two sides as shown and then trim to your correct size unit with the pointy end of the ruler.

Section 1

Section 2

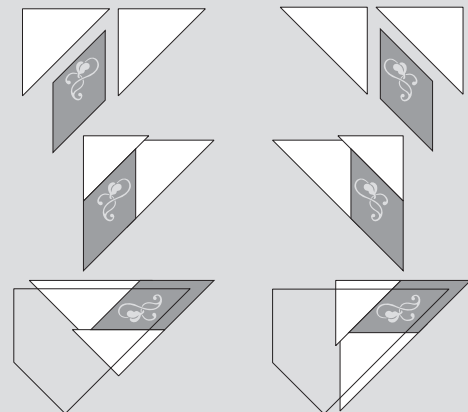

Lemoyne Star Bonus Pattern - Constellation

Finished Size: 37" x 37"

To make this **Rapid Fire® Lemoyne Star** sample project, simply construct the listed number of star blocks and add a few setting pieces and border strips.

Note, most of the stars follow the design of dark star on light background, but not all. Several blocks have light stars on dark backgrounds. Feel free to mix and match as desired.

Also, please note that the finished size star blocks are listed on the diagram but the setting and border pieces are listed by their cut size. It makes sense when you remember that your star blocks will be ½" larger than the finished size listed until they are sewn. Visit our website to see a color photo of the Constellation project.

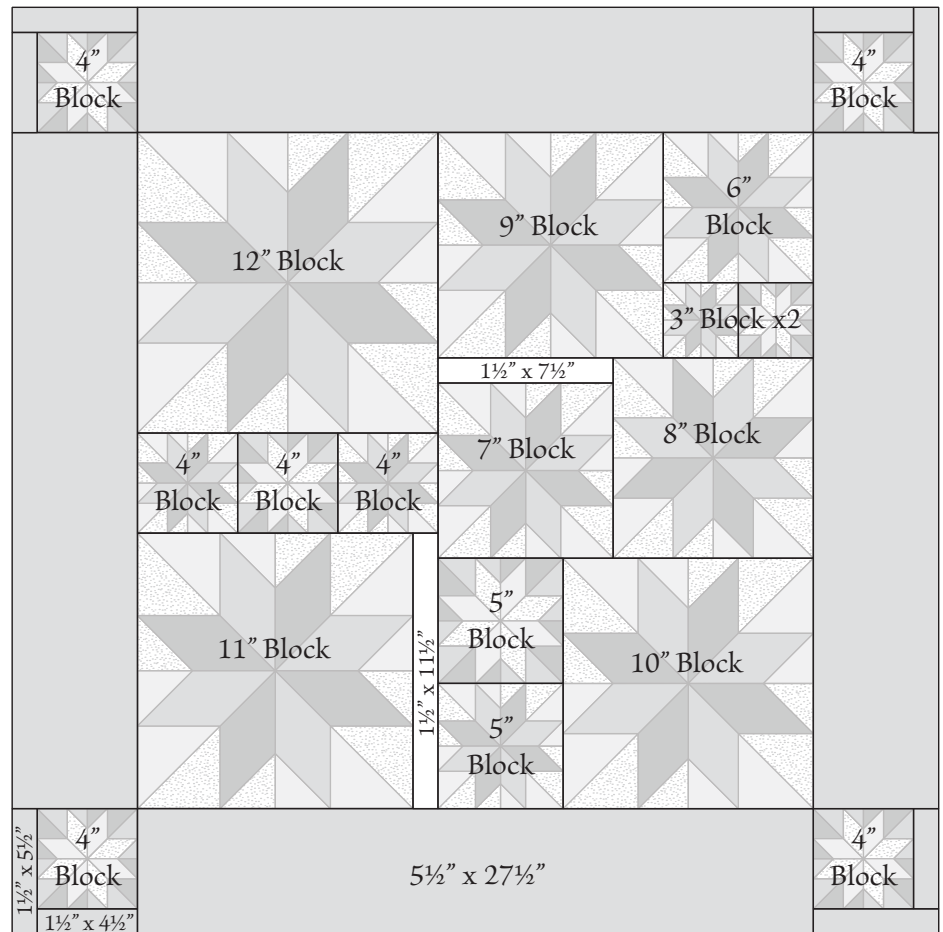

The sampler pictured on our website was made with red and cream scraps. The total yards including the borders and binding break down as follows -

1¾ to 2 yards of assorted dark value fabrics (reds)

1½ to 1¾ yards of assorted light value fabrics (creams)

This should help with the planning of your Constellation sampler project.

For more unique tools and patterns by Deb Tucker and the Studio 180 Design team, visit your local quilt shop or our web site:
Studio180Design.net