

User's Guide

Platinum™ Q | **165**

Stand-up Machine

Platinum Q|165™



User's Guide

© 2019 Singer Sourcing Limited LLC. All rights reserved.

The information contained in this document is subject to change without notice. If you find any problems in the manual, please report them to us in writing. This document is not warranted to be error-free. Singer Sourcing Limited LLC assumes no responsibility or liability for any errors or inaccuracies that may appear in the informational content contained in this manual.

How to Use This Manual

Notes, Important Notes, and Cautions

-  **NOTE:** A NOTE indicates important information that helps you make better use of your Platinum Q|165 quilting machine.
-  **IMPORTANT:** An IMPORTANT note provides information that is essential to properly using your Platinum Q|165 quilting machine.
-  **CAUTION:** A CAUTION indicates a potential for causing harm to your quilting machine, the quilt, or to yourself.

Contents

How to Use This Manual	2
Congratulations on Your Purchase!	4
What's Included With Your Machine.....	4
Important Safety Information (English)	5
About Your Machine	9
General Specifications.....	9
Get to Know Your Platinum Q 165.....	10
Installation and Setup	13
Carriage.....	13
Power Cord.....	13
Stitch Regulation Cable.....	13
Handlebars and Display.....	14
Optional Accessory: Rear Handlebars, Display, and Laser Stylus.....	15
Thread Mast.....	17
Optional Accessory: Ruler Base.....	18
Using Your Machine	19
Power Switch.....	19
Lighting.....	19
Machine Needle.....	19
Hopping Feet.....	21
Bobbin and Bobbin Tension.....	22
Top Thread Tension.....	24
Threading the Machine.....	26

Quilting With the Platinum Q 165	28
Preparing to Quilt.....	28
Using the Handlebar Buttons	28
 Using the Touch-Screen Display	 30
Overview of the Main Screen	30
Stitching Modes.....	32
Controlling the Lights	36
 Machine Tools	 37
On-screen Calculator	37
Diagnostics	38
Alarms	40
Quilt Timer and Stitch Counter.....	42
Set Language	43
Updating Machine Software.....	44
 Information Screen.....	 46
 Machine Maintenance.....	 47
Clean and Oil Your Platinum Q 165.....	47
Maintenance Schedule.....	48
 Troubleshooting	 49
 Appendix 1	 54
Federal Communications Commissions (FCC) Declaration of Conformity (For USA Only).....	54
Canadian Department of Communications Compliance Statement (For Canada Only).....	54
Radio Interference (Other than USA and Canada)	54

Congratulations On Your Purchase!

Welcome to the Husqvarna Viking® family!

Husqvarna Viking® is committed to your quilting success through excellence in customer service and education. With that in mind, we invite you to visit our website at www.HusqvarnaViking.com to learn more about the art of quilting. Plus, you will find tips, tricks and inspiration on a variety of quilting topics including the basics of setting up your machine and loading a quilt.

We invite you to share your projects with us by tagging us in your Facebook and Instagram posts - we may even feature your post. Your new quilting friends are already there and they can't wait to see your creations!

Remember, if you ever have questions, your local retailer can help you or you can contact us by calling (385) 777-5256

Thank you and happy quilting!

- **IMPORTANT:** These packaging materials are designed to prevent the machine from being damaged. Keep them in case you need to bring this machine to the dealer or send it for repair.

Register Your Platinum Q|165 Quilting Machine

For product and warranty registration, go to the Husqvarna Viking® web site at www.husqvarnaviking.com.

What's Included With Your Machine

- Lint brush
- Bobbins (4 pieces)
- INSPIRA™ Needle (134R Titanium) size 16 (pack of 10)
- Bobbin Case
- Thread stand
- Pen Oiler
- Screwdriver
- Power Cord
- 2.5 mm hex tool
- 3 mm hex tool
- Open-toe Foot (Ruler foot installed)
- Bobbin Winder and accessories
- Platinum Q|165 machine (including carriage, front handlebars, front display, and cables)

Important Safety Information

This device complies with Part 15 of the FCC Rules. Operation is subject to the following two conditions: (1) This device may not cause harmful interference, and (2) this device must accept any interference received, including interference that may cause undesired operation. See the full Declaration of Conformity in the Appendix.

- 🔔 **IMPORTANT:** Do not operate your Platinum Q|165 quilting machine until you have completely read the information contained in this manual. Please keep all packaging and order information for warranty purposes.

IMPORTANT SAFETY INSTRUCTIONS

Read all instructions before using this machine.

When using this machine, basic safety precautions should always be followed, including the following:

DANGER — To reduce the risk of electric shock:

- A quilting machine should never be left unattended when plugged in. Always unplug the machine from the electrical outlet immediately after using and before cleaning.

WARNING — To reduce the risk of burns, fire, electric shock, or injury to persons:

- The Platinum Q|165 is heavy. Never attempt to lift it alone. Always use two people when lifting. Always lift from the throat of the machine, not from the handlebars.
- Always unplug the Platinum Q|165 from the electrical outlet when performing any maintenance, changing the needle, removing thread locks, or when left unattended.
- Do not unplug by pulling on cord. To unplug, grasp the plug, not the cord.
- Keep fingers away from all moving parts. Use caution around the needle or sharp external components.
- Change the needle often. Do not use bent or dull needles. “Every quilt deserves a new needle”.
- Switch the machine to the symbol off, or 0, position to turn it off when making any adjustments in the needle area, such as threading needle, changing needle, threading bobbin, changing hopping foot, and so forth.
- Never drop or insert foreign objects into any opening.
- The Platinum Q|165 should only be used indoors away from moisture.
- The Platinum Q|165 should not be stored or used in extreme temperatures.
- Use the Platinum Q|165 only for its intended use as described in this manual.
- To disconnect from the wall outlet, push the switch to the off position, then remove the plug from outlet pulling from the plug, not the cord. Never operate the Platinum Q|165 if the cord is damaged or not working correctly. If a mechanical or electrical problem is encountered, return the Platinum Q|165 to the nearest authorized service center or the manufacturer for examination, repair, electrical or mechanical adjustment.
- It is not recommended that the Platinum Q|165 quilting machine be used with any machine quilting frame other than those recommended Husqvarna Viking®.

- Use this quilting machine only for its intended use as described in this manual. Use only attachments recommended by the manufacturer as contained in this manual.
- Never operate the machine with any air openings blocked. Keep ventilation openings of the machine free from the accumulation of lint, dust, and loose cloth.
- Do not operate where aerosol (spray) products are being used or where oxygen is being administered.
- Do not pull or push the machine across the fabric excessively while stitching. It may deflect the needle enough to cause it to break.
- Use only needles designed for free motion quilting and recommended by Husqvarna Viking® for this machine. Other types of needles may break during normal quilting.
- Children shall not play with the machine. Close attention is necessary when this machine is used by or near children.
- This sewing machine may be used by children age 8 years and above and persons with reduced physical, sensory, or mental capabilities or lack of experience and knowledge, if they are instructed concerning the safe use of the machine, understand the hazards involved, and are supervised.
- Cleaning and user maintenance shall not be made by children without supervision.
- Wear safety glasses.

Save these instructions.

This machine is intended for household or commercial use.

Disclaimer

Husqvarna Viking® and its Representatives are in no way legally responsible or liable for damage to the Platinum Q|165 when used improperly or not in accordance with the guidelines stated in this manual or when used on machine quilting frames not recommended by Husqvarna Viking®.

To use the machine safely

1. Carefully watch the needle when sewing. Do not touch the hand wheel, take up lever, needle, or other moving parts.
2. Turn the machine off and unplug the cord in the following cases:
 - when you have stopped using the machine
 - when you replace or remove the needle or any other part
 - when you check or clean the machine
 - when you leave the machine unattended
3. Connect the machine directly to the wall outlet or to a surge protector that connects directly to the wall outlet. Do not use extension cords.

To increase the life of your machine

1. Do not store this machine in areas exposed to direct sunlight or high humidity. Never use or store the machine near a heater, an iron, a halogen lamp or other hot things.
2. Use only neutral soaps or detergents to clean the machine. Benzene, solvents and scouring powders can damage the case and the machine and therefore should never be used.
3. Do not drop or bump the machine.
4. Always consult the manual to replace or fix the hopping foot, needle or any other part of the machine. If necessary contact an authorized Husqvarna Viking® representative or technical support.

Optional U.S. Grounding for Customers with 120 VAC Connections

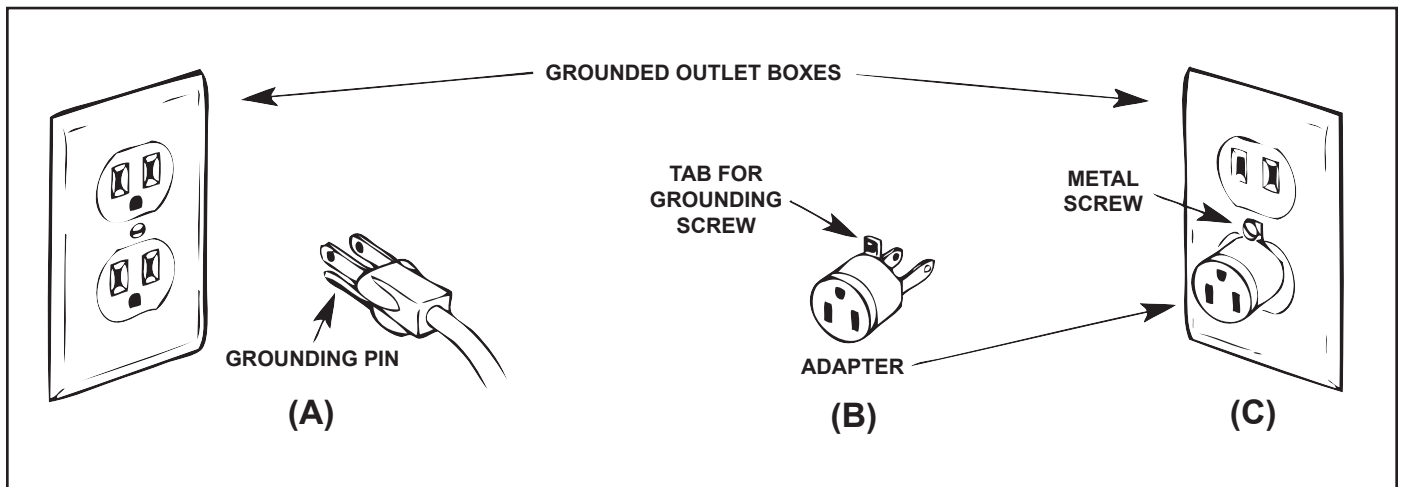

This product is for use on a nominal 120 V or nominal 220 V circuit, and has a grounding plug that looks like the plug illustrated in sketch A above. A temporary adapter, which looks like the adapter illustrated in sketches B and C, may be used to connect this plug to a 2-pole receptacle as shown in sketch B if a properly grounded outlet is not available. The temporary adapter should be used only until a properly grounded outlet can be installed by a qualified electrician. The green colored rigid ear, lug, and the like, extending from the adapter, must be connected to a permanent ground such as a properly grounded outlet box cover. Whenever the adapter is used, it must be held in place by the metal screw.

➡ **IMPORTANT:** In Canada, the use of a temporary adapter is not permitted by the Canadian Electric Code.

To repair or adjust the machine

If the machine breaks down or needs adjustment, first check the troubleshooting chart in the appendix to inspect and adjust the machine yourself.

For more product information and updates, visit our website at www.HusqvarnaViking.com.

The contents of this manual and product specifications are subject to change without prior notice. Check for updated manuals at www.HusqvarnaViking.com.

About Your Machine

General Specifications

The Platinum Q|165 uses high-tech electronics and an innovative touch-screen user interface to offer greater functionality and ease of operation to home quilters than ever before conceived in the quilting industry. The Platinum Q|165 quilting machine is a high quality machine that both incorporates robust design features and is easy to service.

Sewing Opening Dimensions	8.25 inches X 16 inches (245 mm X 610 mm)
Sewing Speed	Manual Mode: from 25 stitches per minute to 1800 stitches per minute Regulated Mode: from 0 stitches per minute to full speed
Stitches Per Inch	4 stitches per inch to 18 stitches per inch
Needle System	134 (135 X 7)
Needle Sizes (recommended)	From 80/12 to 125/20
Hook System	Rotary, Horizontal Axis, M-class bobbin
Bobbin Type	Aluminum, Class M
Bobbin Case	Type MF
Motor Type	Brushless DC
Needle Positioning	Up and down, walking stitch
Electrical Power	
US/Canada*:	105 – 120 VAC, 47-63Hz, 300W peak
Rest of world:	100 – 250 VAC, 47-63Hz, 300W peak
	* Complies with international certifications
Sew Foot Stroke/Lift	5 mm
Needle Bar Stroke	35.3 mm
Take-Up Stroke	73 mm
Lubrication, main components	Kluber Lube, permanent
Lubrication of hook	Velocite 10, Texaco 22

Get to Know Your Platinum Q|165

Right side view

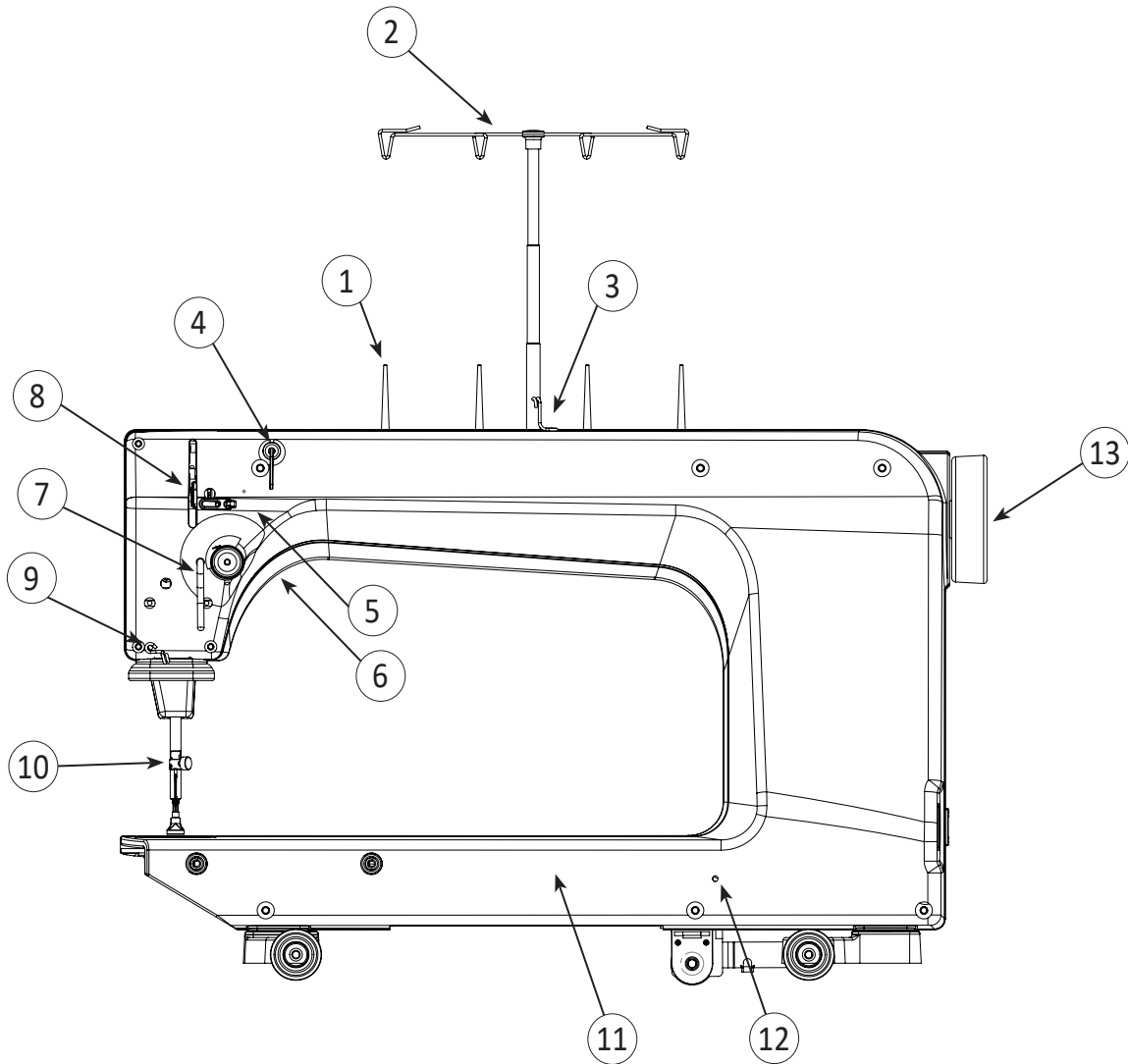

1. Spool Pin
2. Thread Mast
3. Thread Guide A
4. Three-Hole Thread Guide B
5. Thread Guide C
6. Top Thread Tension Assembly
7. Stirrup Thread Guide E
8. Take-Up Lever
9. Thread Guide F
10. Needle Bar Thread Guide
11. Front Casing/Frame
12. Side Laser Stylus Post Hole
13. Hand Wheel

Left side view

- 14. Needle Bar
- 15. Needle Bar Clamp Screw
- 16. Needle Bar Thread Guide
- 17. Needle
- 18. Ruler Foot
- 19. Needle Plate
- 20. Sewing Feet mount
- 21. Presser Bar
- 22. Front Threaded Display Mounting Holes
- 23. Color Touch-Screen Display Connector
- 24. Threaded Horizontal Spool Pin Mounting Hole
- 25. Spool Support
- 26. Front Base
- 27. Ruler Base Post
- 28. Back Casing/Frame
- 29. Machine Stitch Regulation Encoder
- 30. Rear Base

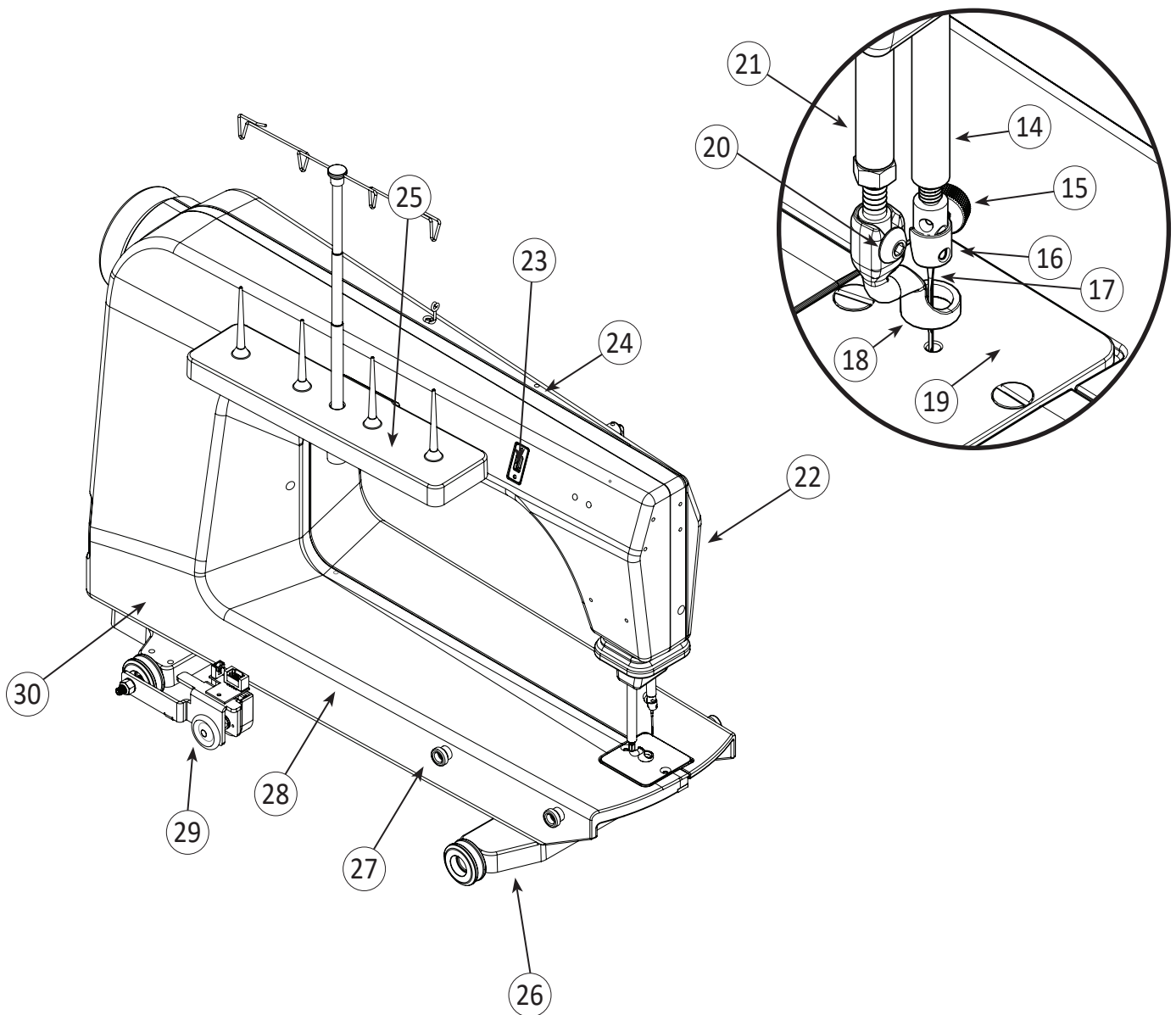

Rear and Front Views

- 31. Serial Port for Stitch Regulator
- 32. Rear Handle Bar Serial Port
- 33. Rear Threaded Handle Holes
- 34. Power Cord Connector

- 35. Fuse Holder
- 36. On/Off Switch
- 37. Bobbin Assembly
- 38. LED Light Ring

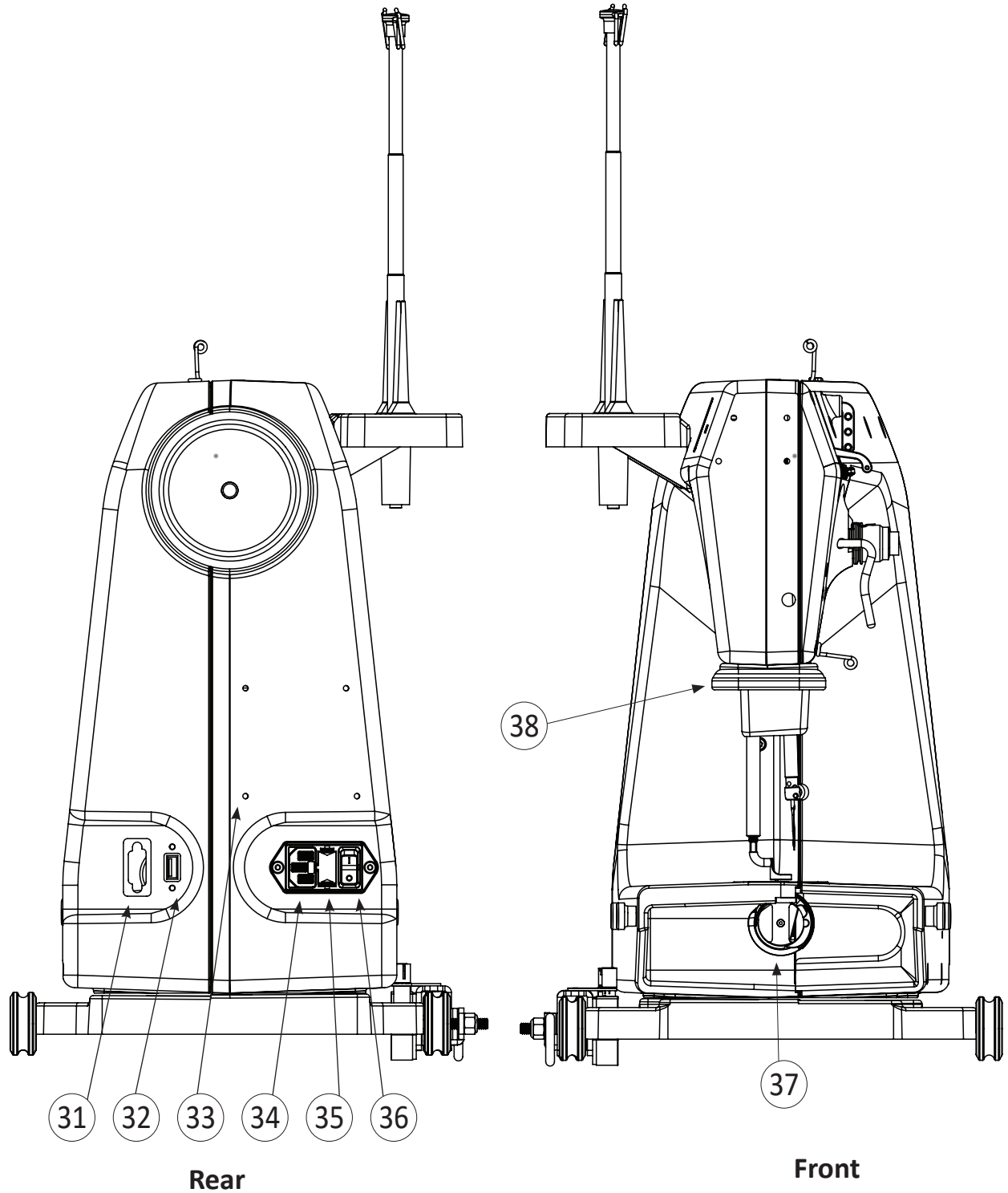

Installation and Setup

Power Cord

To install the power cord

- Insert the cord into the power connector on the rear of the machine. Secure the cord with the metal clip. Plug the three-prong end into power source. Do not turn on the machine until the front handlebars and display are installed.

To disconnect the power cord

- Unplug the cord from the power outlet. Release the metal clip where the cord connects with the machine and then pull out the cord.

For more information, see *Power Switch* in the *Using Your Machine* section of this manual.

-  **NOTE:** Make sure that the machine is off before plugging into power source. The rear power switch should be in the 0, or off, position.

Carriage

You should have already set up the quilting frame. Refer to the frame manual for detailed instructions about setting up the frame.

To install the carriage and machine on the frame

1. Place the carriage on the table rails, ensuring that the carriage encoder assembly will be toward the back of the machine (the power cord side of the machine).
2. Place the machine on the carriage.

- △ **CAUTION:** The Platinum Q|165 is heavy. Never attempt to lift it alone. Always use two people when lifting. Always lift from the throat of the machine, not from the handlebars or needle bar.

3. The stitch regulation cable is usually already connected to the machine encoder. The connector in the middle of the stitch regulation cable, plugs into the machine encoder. The two cables are secured with clips on the machine which helps manage them.

4. The remaining length of cable with a connector on the very end plugs into the carriage encoder.

- ☞ **IMPORTANT:** Make sure the keyed portion of the cable connector aligns with the keyed portion of the encoder connector. Do not force.

- ☞ **IMPORTANT:** If the machine is to be removed from the carriage, the cable must first be disconnected from the carriage encoder assembly. The other two connectors on the cable should remain in place. Failure to unplug the cable when removing the machine from the carriage could result in damage to the cable, encoders, and carriage.

Handlebars and Display

△ **CAUTION:** To prevent any electrical damage to the handlebars, always turn off all power to the machine when connecting or disconnecting the handlebars.

To install the handlebars

1. Ensure that the machine is unplugged from the electrical outlet.
2. Locate the four screws and the 3 mm Hex tool. Line up the holes on top of the handles with the pre-drilled holes on top of the machine.
3. Slide a single screw into one of the holes until it stops. Hand tighten the bolt enough to secure the handles to the top of the machine. Insert and hand-tighten the remaining two handlebar bolts.
4. Use the included 3 mm Hex tool to securely fasten the handles to the front of the machine.



5. After the bolts are in place, plug the cable into the USB-style connection located on the front-left side of the machine.
6. Remove the protective plastic from the touch-screen display before using.

To use the handlebar buttons

Press the Up/Down button to cycle the needle a half stitch.

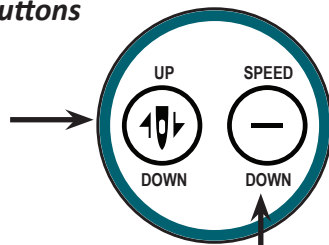

Press the Speed Up or Speed Down buttons to change the stitches per minute setting (manual mode) or stitches per inch (regulated mode).

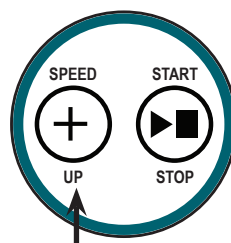

Press the Start/Stop button to start or stop the machine from stitching.

Optional Accessory: Rear Handlebars, Display, and Laser Stylus

To install the optional rear handlebars and display

➤ **IMPORTANT:** Install the rear handlebars and display after the front handlebars and display have been installed.

1. Check that the machine is unplugged from the electrical outlet.

△ **CAUTION:** All power to the machine must be turned off when installing the rear handlebars. Failure to do so can result in damage to the machine.

2. The rear handlebars come mounted to a bracket. Line up the four holes in the bracket with those on the rear of the machine.

3. Slide the four bolts into holes until they stop. Hand tighten, and then use the 3 mm wrench to securely fasten the handles to the back of the machine.

4. After the four bolts are in place, plug the small connector end of the cable into the port on the left side of the display. Push the plug securely into place.

5. Securely plug the other end of the cable into the port on the back of the machine below the handlebars.

✎ **NOTE:** See the instructions that accompany the Rear Handlebars and Display.

➤ **IMPORTANT:** After the rear handlebars have been completely installed and plugged in, test them by turning on the Platinum Q|165 and looking at the rear display. If nothing appears on the screen, check that both the front and rear handlebar cables are plugged in securely, that your machine is turned on, and that the power cord is plugged into the machine as well as a power source.

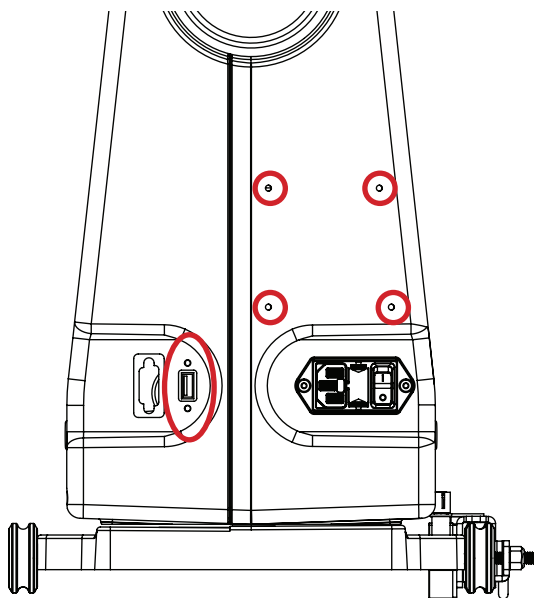

The laser light (for use with paper pantographs) attaches to a mounting post with a clamp. The mounting post attaches to a threaded hole on the thread-path side of the Platinum Q|165.

To install the optional laser stylus

1. Place the nut on the laser stylus post with the washer under it and thread the laser post into the threaded hole, near the rear wheel base. Turn until securely in place. Lock in place with nut.

 **NOTE:** The washer will be under the nut to protect the machine paint. You can also mount the laser on an unused spool pin.

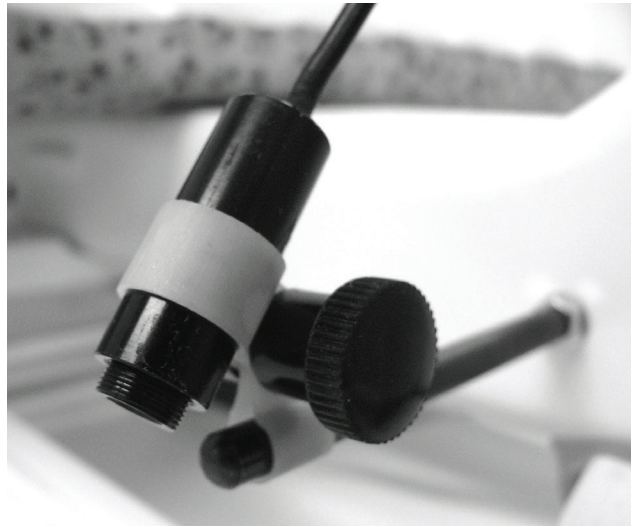

2. Insert the laser stylus into the laser clamp.
3. Slide the laser clamp over the post to the desired height and ensure it is secure.
4. Plug the laser's cable into the Laser Stylus Power Connector. When this cable is plugged in, the laser receives power and is turned on. To turn off the laser, unplug the cable.

The laser projects a straight laser beam visible as a dot on surfaces it hits. Use the laser dot as a guide, or stylus, to trace printed pantograph designs and stitch the continuous pattern onto a quilt.

The laser stylus can move in any direction by rotating the clamp on the post and pivoting the laser up or down. To make an adjustment, loosen the black thumbscrews, position, and retighten.

 **IMPORTANT:** A label is attached to the laser's case and contains an arrow which indicates the direction the laser light will shine when energized. The label must remain in place on the laser. Removing the label voids the laser's warranty.

Laser Operation and Safety

Be sure the laser is attached to the machine and pointed downward toward the table before connecting it to the port. Never point it in a direction that would project the beam into someone's eyes. If the laser should stop working, ensure the plug is firmly seated into the Platinum Q|165 laser port.

Laser Focus and Image Size

Focus the laser by turning the threaded housing surrounding the lens clockwise or counterclockwise. The laser image can be adjusted to project a bigger or smaller dot, or focal size. The direction of rotation needed is determined by the distance of the laser from the pantograph surface. Experiment by rotating the threaded end to achieve your desired focal size.

Laser Safety

When using the laser stylus, observe the following basic safety precautions.

- Never shine directly into the eyes.
- The laser stylus should never be left on and unattended.
- Do not use the laser stylus as a toy.
- Pay close attention when the laser stylus is being used by or near children or pets.
- Use the laser stylus only for its intended use as described in this manual.

 **NOTE:** If you can't see the threaded housing, the lens may be threaded too far into the laser body. You will need to use a large slotted screwdriver to turn it counter clockwise until the housing is visible. You can then rotate it with your fingertips to bring the light into focus. Be very careful to not scratch the lens when using the screwdriver.

 **CAUTION:** Use of controls or adjustments or performance of procedures other than those specified herein may result in hazardous radiation exposure.

Installing the Thread Stand

1. Locate the two threaded holes on the left side of the machine, near the top and towards the middle.
2. Remove the 2 screws. Line up the holes of the thread stand with the holes on the machine and reinsert the screws.
3. Turn the thread stand until the eyelets are positioned over the spool pins.

 **NOTE:** The eyelets of the thread stand **MUST** be centered over the spool pins. This ensures that the cone of thread will not pull, turn or tilt, which will cause thread tension problems.

Optional Accessory: Ruler Base

If you plan to use rulers and templates with the Platinum Q|165, you need to purchase the ruler base to give you a large, stable surface on which to rest the ruler or template. The ruler base, rulers, and templates are optional accessories.

To install the optional ruler base

1. The Platinum Q|165 comes with four preinstalled mounts for the ruler base.
2. Tilt the ruler base down about 30 degrees and align the ruler base brackets with the four machine mounts.
3. Push the ruler base down and back onto the machine mounts.

To remove the ruler base

- Start by lightly pulling out and then up to remove the ruler base from the machine mounting tabs.

To use rulers and templates with your quilting machine

△ **CAUTION:** Use only one-quarter inch thick rulers and templates with your machine. Do not use rotary-cutting rulers as they are too thin and can easily slip under the hopping foot. Always use a ruler base or extended table to stabilize the ruler.

Keep the ruler flat and quilt only where you are securely holding the ruler.

- Apply gentle three-point pressure to the ruler, as follows.
 1. Press the ruler against any side of the hopping foot.
 2. Press ruler down against ruler base with only as much pressure as necessary to keep the ruler from slipping. Too much pressure will keep the machine from moving freely.
 3. While stitching, consistently press the hopping foot against the edge of the ruler.

The machine's hopping foot stitches a quilting line that is a quarter inch away from the ruler edge.

✎ **NOTE:** Set the machine to stop in the needle-down position to keep the machine from moving while making adjustments with the ruler.

Using Your Machine

Power Switch

The power switch is at the rear of the machine. Turn it on by toggling the switch from the 0 position to the 1 position.

- **IMPORTANT:** If you will not be using the machine for more than a day, we recommend you turn off the machine and unplug the power cord from the power source.
- **IMPORTANT:** Refer to the safety instructions.

Lighting

The Platinum Q|165 includes an LED light ring that illuminates the needle and stitching area. The light automatically comes on when you turn on the machine. Turn off the lights using the Lights button on the Main Screen. For more information about turning on and off the LED light ring, see *Overview of the Main Screen* in the *Using the Touch-Screen Display* section of this manual.

Machine Needle

Use only the recommended needle system for your Platinum Q|165 quilting machine. The machine was timed to use this specific type of needle and it is designed to work with the high quilting speeds and multidirectional stitching the Platinum Q|165 offers.

The Platinum Q|165 uses the 134 needle system. Note that the needle has a round shank rather than a shank with a flat side like home sewing machines use.

If you use the recommended needle, you will experience:

- Fewer skipped stitches
 - Less needle breakage
 - Less thread breakage, especially at high speeds
 - Less thread splicing or shredding
 - Optimum fabric protection
- **IMPORTANT:** Change the needle regularly. We recommend you use a new needle for each new quilt loaded on the machine, and any time the needle becomes bent, dull, or burred.
- △ **CAUTION:** A damaged needle may result in poor stitch quality or may even damage the machine or your quilt.

To change the needle

1. Move the needle bar to the highest position by turning the rear hand wheel or pressing the needle up/down control on the handles. Then turn off the power.

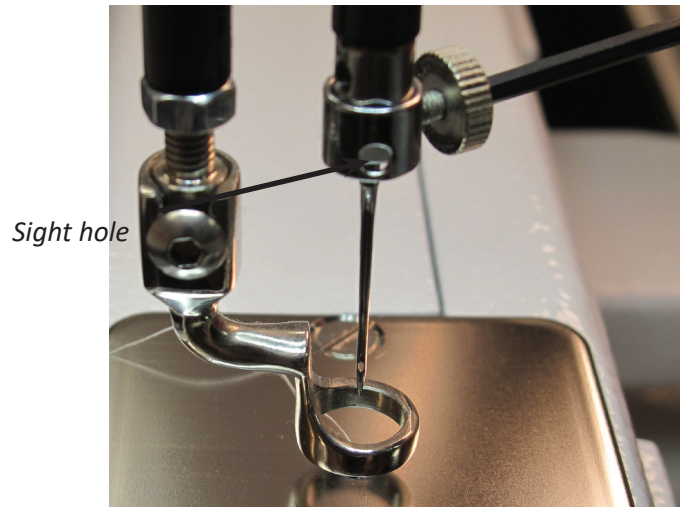

2. Loosen the needle-bar-clamp thumb-screw.
3. Remove the old needle by pulling it down.
Discard the old needle in a safe way.

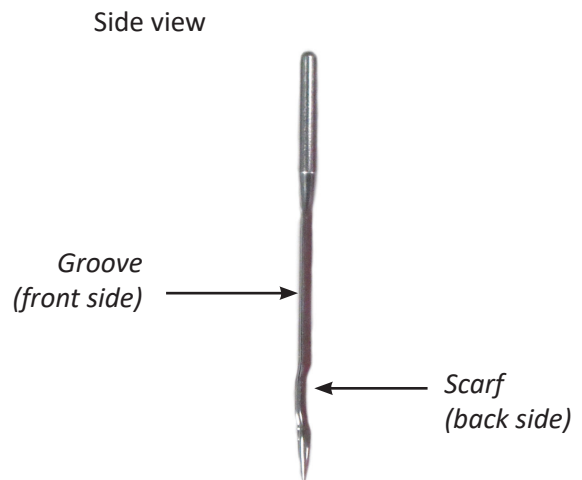

4. With the scarf (small ground-out section/dip on the back side of the needle just above the needle eye) facing toward the back hand-wheel side of the machine, push the needle all the way up into the needlebar, until it can go no farther.

5. Carefully tighten the needle bar clamp screw until the needle is securely fastened into the machine. If necessary use the 2.5mm hex tool to secure the needle; however take care not to over tighten the screw. This may result in damaged or stripped threads in the needle clamp. Damage to the needle clamp may also make it difficult to fully insert the needle, which will change the machine timing causing more issues. Stripped threads and damage caused by improper needle installation or tightening are not covered under warranty.



-  **NOTE:** It is recommended to use a new needle for each new quilt. Also, replace the needle any time it becomes bent, dull or burred.
-  **IMPORTANT:** Check the needle to confirm it is fully inserted. The needle bar has a stop/sight hole above the needle bar clamp screw. Make sure the needle is touching the top of the stop/sight hole. If it is not, the machine timing will be off and it may be possible for the needle to collide with internal parts, causing damage not covered by warranty.
-  **CAUTION:** Your Platinum Q|165 machine stitches at a much faster speed than your home sewing machine, therefore, it is essential that the needle is seated into the needle bar and fully tightened (but not over tightened). Check often that the needle has not become loose. If the needle comes loose, it could break in the machine causing damage, alter the machine's timing, or cause bodily harm.

Needle size	Thread size
12 and 14	monofilament, 100 wt. silk, 60 wt. poly, mylar
16	monofilament, hologram, 100 wt., 80 wt., 60 wt., 50 wt., 40 wt. silk, poly or cotton thread
18	40 wt. cottons and poly, 30 wt. cottons and poly
20	Any thread 30 wt. and heavier such as 12 wt., 19 wt., 30 wt.

Machine Quilting Tip: Needle Requirements

For general quilting, a size 16/100 needle will accommodate most threads and fabrics. Heavier threads, such as top stitch and some decorative threads, require a larger needle such as 18/110 or 20/125. Lofty batts and heavier fabrics such as denim, canvas, or densely woven fabric may also require a larger needle.

Hopping Feet

Your machine comes with two hopping feet: a ruler foot (comes installed) and an open-toe foot. Use the ruler foot for everyday quilting and ruler work, and use the open-toe foot when you need greater stitch visibility (such as when you are micro quilting).

To change the hopping foot

1. Remove the foot that is on the mount by using the 2.5 mm hex tool to loosen the mounting screw far enough that you can slide the foot off of the mount.
2. Slide the desired foot onto the mount. Note that the opening on the side of the foot is lined up with the screw hole. Push the foot up as far as it will go.

 **NOTE:** You may need to push up the pressure bar when changing the hopping foot.

3. Fully tighten the screw with the 2.5 mm hex tool.



Bobbin and Bobbin Tension

The Platinum Q|165 quilting machine uses M-class bobbins that are larger than sewing machine L-class bobbins. The larger bobbins hold more thread, enabling you to quilt for a longer time between bobbin changes.

To wind the bobbin

The Platinum Q|165 comes with a separate bobbin winder. For full instructions about using the bobbin winder, see the instruction manual that was packaged with the bobbin winder.

To insert the bobbin into the bobbin case

△ **CAUTION:** To prevent personal injury always turn off the power switch while inserting or removing the bobbin case or whenever your hands are near the needle area, such as when you change the needle.

1. Place the bobbin in the bobbin case so that the thread pulls off clockwise when viewing the open side.
2. Slide the thread through the slot and under the tension spring, leaving approximately five to six inches of thread hanging loose.



To test bobbin tension

The bobbin tension is the foundation tension for the entire machine. Always set the bobbin tension first.

✎ **NOTE:** Check the bobbin tension each time a new bobbin is inserted.

1. With the bobbin properly in the bobbin case, hold the bobbin case in the palm of your hand with the open end facing up.
2. Wrap the thread two to three around the index finger of the opposite hand and lift the bobbin up. The bobbin case should lift up on its side, and slightly lift out of your hand. If the bobbin will not lift up on its side, the bobbin tension is too loose and if it lifts out of your hand, the bobbin tension is too tight.

To adjust the bobbin tension

- Make the bobbin tension adjustment using the screw in the center of the tension spring. Turn clockwise to tighten and counterclockwise to loosen the bobbin tension. Make tiny adjustments to the bobbin tension and test again.



To insert the bobbin case into the machine

1. Move the needle to the up position. Turn off the power to the machine.
2. Place the bobbin in the bobbin case so that the thread pulls off clockwise when viewing the open side.
3. Slide the thread through the slot and under the tension spring, leaving 5 to 6 inches of thread hanging loose.
4. To fit the bobbin case onto the hook spindle in the machine, orient the bobbin case as shown in the photo with the alignment notch to the right. Push the bobbin case inward until it clicks into place.



 **NOTE:** Do not insert the bobbin case into the machine by lifting the lever on bobbin case. Use the lever only for removing the bobbin case.



Top Thread Tension

One of the joys of quilting with the Platinum Q|165 is its ability to handle many different types of thread. You can quilt with almost any high-quality thread as long as you first adjust the bobbin tension and then adjust the top tension to suit the thread you've chosen.

Puckering, gathers, and thread breakage occur when the top tension is too tight. Loops and thread nests occur when the top thread tension is too loose or you are using a poorly wound bobbin. Tension may need to be adjusted depending on the fabric, thread, or batting you are using on the project.

-  **NOTE:** Top tension should be adjusted after the bobbin case foundation tension adjustment is made.
-  **NOTE:** Dark threads will be thicker (because of dye) than light threads of the same weight. The type or brand of thread may also affect tension settings. Each time you change threads, you should check your tension.
-  **IMPORTANT:** Before adjusting the top tension remember to pull the top thread up into the tension discs (flossing the thread). Otherwise it will float outside the discs providing little or no top tension. This could cause thread nesting problems on the bottom side of the quilt.

Machine Quilting Tip: Test the tension settings before quilting

The best way to make sure the top and bottom tension settings are balanced is by quilting. Keep 4-inch squares of light solid fabric on hand to place at the side of the quilt on the extra batting and backing. Then quilt some loops and swirls and look at the stitches on top and bottom to ensure the tension looks balanced. Fine tune the top tension as needed.

To adjust the top tension

- Test stitching with a scrap of fabric placed on the extra batting and backing at the side of the quilt. Adjust the tension knob as follows until you have balanced tension. Continue to test the stitching on the fabric scrap until you are happy with the tension.

To tighten top tension

- To adjust the top thread tension to be tighter, turn the tension knob **clockwise**.

To loosen top tension

- To adjust the top thread tension to be looser, turn the tension knob **counterclockwise**.

-  **NOTE:** Unlike the bobbin case tension adjustment, which requires minute adjustments, the top tension knob may require turns anywhere from a quarter of a turn to two to four turns to achieve balanced tension.

Tension Quick Start Guide

Bobbin adjustments are tiny, like ticks of the clock.

1. Always adjust bobbin thread tension first. Then stitch out to check top tension.

2. If top thread looks like Diagram A

Problem: The top thread tension is too tight.

Solution: Loosen the top thread tension by turning the tension knob counterclockwise.

3. If top thread looks like Diagram B

Problem: The top thread tension is too loose.

Solution: Tighten the top thread tension by turning the tension knob clockwise.

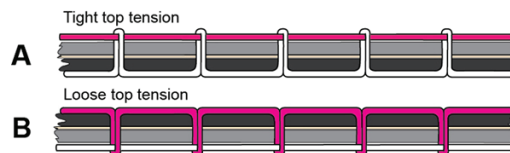
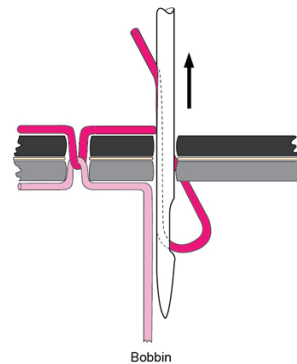

Threading the Machine

Platinum Q|165 recommends that you select and use only high-quality threads for your quilts.

To thread the machine

Refer to the threading diagram on the next page.

1. Place thread cone onto spool post ①, insert the thread through the thread-mast eyelet ② from back to front, continuing to the thread guide ③.
2. Continue to the three-hole thread guide ④. Wrap the thread through all three holes from back to front, being careful not to cross threads. This is recommended for most threads. However, some very delicate threads or metallic threads may require less tension. If you are having problems with thread breaking, try threading only one or two holes of the three-hole thread guide.
3. The thread continues down to thread guide ⑤ and to the tension assembly ⑥.

🔊 **IMPORTANT:** The thread must be flossed up between the two tension discs. If the thread is not firmly in place between the two tension discs, the thread will lay on top of the tension discs (no tension) and thread looping on the bottom of the quilt can occur.

4. After the thread is in place, be sure that the thread catches on the take-up spring and then pull it down under the stirrup thread guide ⑦.
5. Bring the thread up and through the take-up lever from back to front ⑧, and then to the pigtail thread guide ⑨, and thread through the needle bar thread guide hole ⑩.
6. Make sure the thread is following the groove down the front of the needle and insert thread through the eye of the needle from front to back 11. While pulling thread through the eye of the needle, be careful that the thread does not twist around the needle.

✍ **NOTE:** Before threading the needle, confirm that the machine is threaded properly and the tension is correct by carefully pulling the top thread. It should pull smoothly with light to medium tension. If thread pulls freely with no tension, rethread the machine, ensuring that the thread is flossed into the tension discs.

🔊 **IMPORTANT:** The Platinum Q|165 does not have a presser foot lever or top tension release like a home sewing machine. On a home sewing machine the top tension is released when the presser foot is raised, allowing the thread to come freely out of the machine. When a home machine is threaded the tension discs are released and open to allow the thread to easily fall between the tension discs. This isn't the case with the Platinum Q|165 quilting machine. The top tension is always tight and the tension discs are never open. Therefore the thread must be pulled up, or flossed, between the tension discs or it will stay outside the discs and float without tension, causing serious tension problems and/or thread nests.

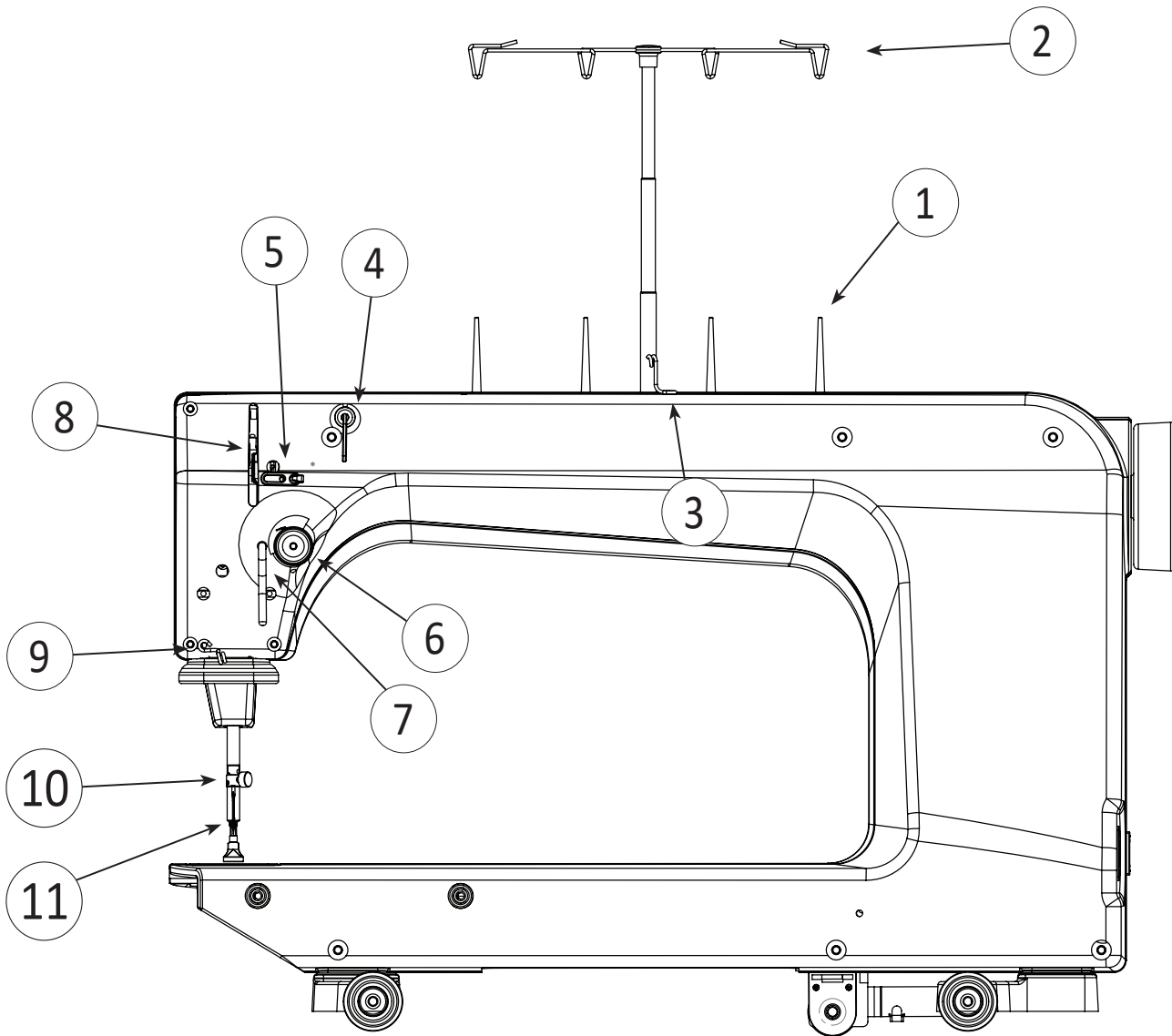

Quilting With the Platinum Q|165

Preparing to Quilt

1. Make sure your machine has been cleaned, oiled, has a new needle, and that the tracks on the frame are free from threads or other debris. If the machine isn't already plugged in, plug it in now.
2. Select your thread and wind one or more bobbins.
3. Turn on the power switch at the back of the machine.
4. Set your bobbin tension and thread your machine.
5. After loading your quilt, use a scrap of fabric along the edge of the quilt backing and batting to test the top tension. Make adjustments to the top tension as needed.

Using the Handlebar Buttons

To bring bobbin thread to the top of the quilt

1. After the machine is threaded, move the machine over the quilt to your starting location.
2. While firmly holding the tail of the needle thread, press the needle up/down button twice, causing the needle to go down through the quilt sandwich and then back to the up position. Or press and hold the up/down button until the needle does a full revolution; then release the button.
3. Move the machine four to six inches while holding the needle thread in place. The bobbin thread will pull up through to the top of the quilt.
4. Grasp the bobbin thread loop and pull it to the desired length. Reposition the needle to the starting location, tie off the threads by quilting a few stitches in place. Then begin quilting.



To start or stop quilting

- Start or stop the machine at any time by pressing the Start/Stop button on the handlebars.



To tie off threads when starting and ending quilting

1. After the machine is threaded, move the machine over the quilt to your starting location.
2. While firmly holding the tail of the needle thread, press the needle up/down button twice, causing the needle to go down through the quilt sandwich and then back to the up position. Or press and hold the up/down button until the needle does a full revolution; then release the button.
3. Move the machine four to six inches while holding the needle thread in place. The bobbin thread will pull up through to the top of the quilt.
4. Grasp the bobbin thread loop and pull it to the desired length. Reposition the needle to the starting location, and tie off the threads by quilting a few stitches in place. Then begin quilting.

Using the Touch-Screen Display

The Platinum Q|165 has a touch-screen display on the front handlebars. Use the display to access the quilting functions of the Platinum Q|165, such as to alternate between stitch-regulated and non-stitch regulated operation, to control settings for how you prefer your machine to operate, and to use tools such as counting stitches on a quilt or logging how much time it took to finish your quilt.

Buttons are selected, or on, when they are blue and display white text or graphics. Buttons are off when they are white. When you touch a button, it will toggle on or off, open a pop-up box for you to enter information, or open a screen with more options.

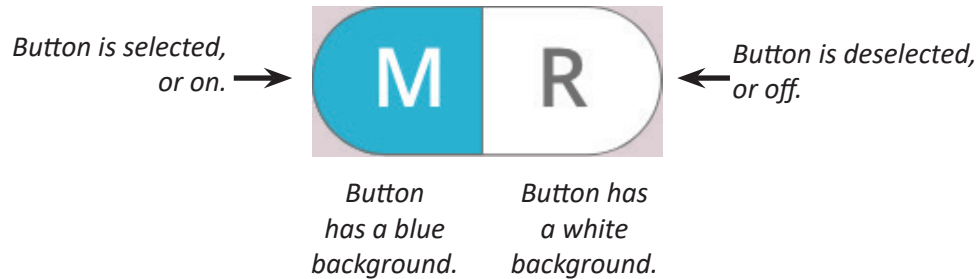

Overview of the Main Screen

The Platinum Q|165 Main screen provides quick access to all functions.

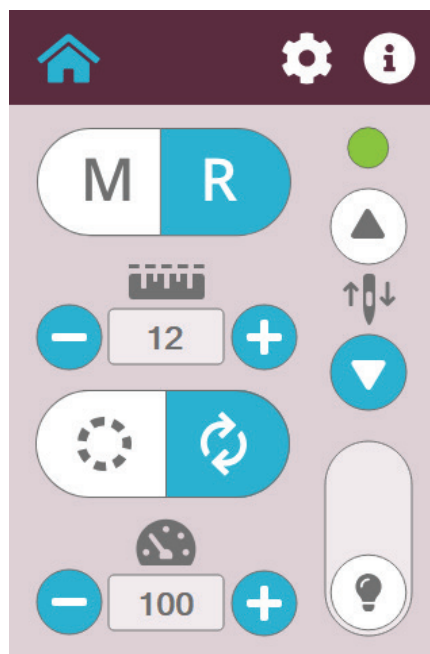

Toolbar Options

The toolbar is in the upper-right corner of the screen at all times. The button appears blue when it is selected.



Touch the Home icon whenever you need to return to the Main screen.



Touch the Tools icon to open the Tools. For more information about the various tools, see the *Machine Tools* section of this manual.



Touch the information icon to see system information such as the machine's hardware and software version numbers, as well as the machine's lifetime stitch count. For more information about the system information that is available, see *Information Screens* in the *Toolbar Options* section of this manual.

Other buttons on the Main Screen



Needle-stop button: Touch the button to alternate between having the needle stop in the up or down position when you stop stitching. Your choice displays in blue (as shown at the left).

This button does not move the needle, but rather indicates your preference for the final needle position when quilting is stopped.



On/Off Indicator: The circle above the Needle-stop button turns blue when you press the Start/Stop button on the handles, indicating that the needle is in motion. When you stop quilting by pressing the Start/Stop button on the handlebars again, the circle turns red, indicating that the needle is not moving.



LED lights button: Touch the LED lights button to turn lights on or off.

Stitching Modes

The Platinum Q|165 enables you to choose between two modes of stitch regulation (Cruise and Precision) or to choose manual stitching.

Manual Stitching Mode

When using the manual stitching mode, the length of the stitch is determined by how quickly or slowly you move the machine around the quilt, in combination with the number of stitches per minute (up to 1800) you have selected. For a consistent stitch length, move the machine at a consistent speed. Experiment with different combinations of quilting speed and stitches per minute to find what optimally works for you.

To use manual stitching mode

- Touch the **Manual** button and then specify the stitches per minute (SPM) by pressing the plus (+) or minus (–) buttons on the screen or selecting one of the two white boxes with a stitches-per-minute preset. Pressing the plus (+) or minus (–) buttons on the screen to change the stitches per minute has the same effect as pressing the plus (+) or minus (–) buttons on the handlebars while in Manual mode.

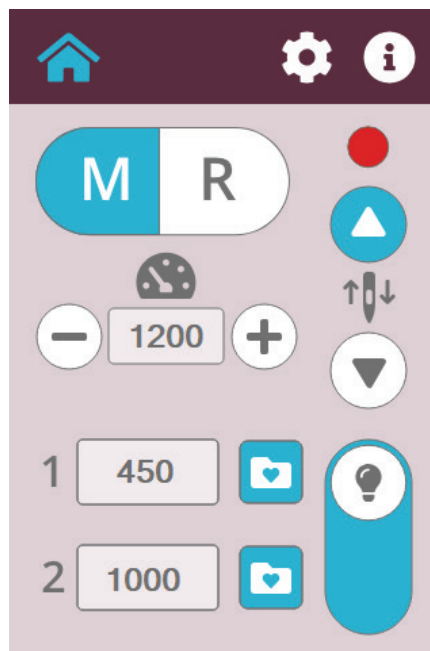

To configure the manual stitching mode preset speeds

The manual mode preset speeds are two stitches-per-minute speeds, up to 1800 stitches per minute (SPM), that are saved for quick access from the Main screen. After you set the speeds, you can choose one of the presets when in Manual stitching mode and it becomes the current speed. Perhaps you want one speed when doing overall quilting and another speed for micro quilting.

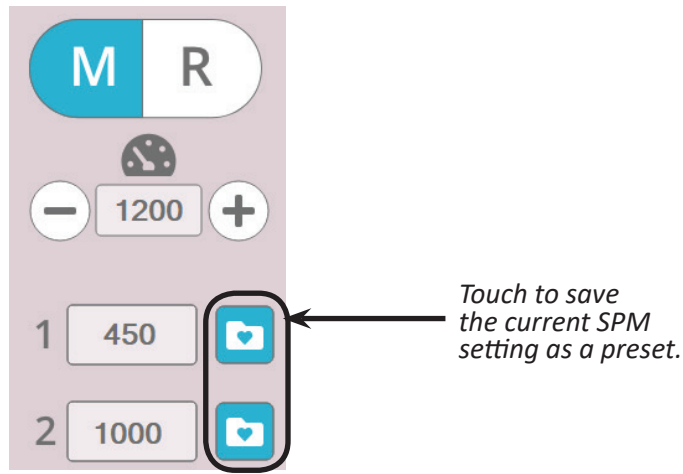

1. Select Manual stitching mode by touching the **Manual Mode** button.
2. Press the plus (+) button to increase or the minus (-) button to decrease the current stitches-per-minute setting.
3. Touch the **Save** button next to one of the stitches-per-minute presets to save the current setting as a preset.

Machine Quilting Tip: Getting started with Manual Mode

Set the machine at a medium speed (such as 900) and begin moving it until you become accustomed to the resistance. By moving the machine faster, the stitches will begin to elongate. Either increase the stitching speed or move the machine more slowly to get the stitches at your desired length. When you move the machine more slowly, the stitches get shorter. If you move it too slow, stitches can build up on top of each other, break the thread, or make it extremely difficult to unpick. Decrease the stitching speed, while maintaining a constant motion with the machine, to bring the stitches to the desired length.

Stitch Regulation

Stitch regulation maintains a consistent stitch length (stitches per inch) regardless of how quickly or slowly you move the machine.

Machine Quilting Tip: Getting started with stitch regulation

Set the machine to your desired stitch length. Begin moving the machine to become accustomed to the resistance. The machine motor will slow down or speed up to maintain a consistent stitch length according to how quickly or slowly you move the machine. Moving the machine too fast or in radical or jerky movements will defeat the stitch regulator function.

Machine Quilting Tip: Quilting speed while in stitch-regulation mode

It is unlikely that you will move the Platinum Q|165 across the quilt too fast. However, if you do, it will result in an overspeed condition if the machine can't maintain stitch regulation.

There are two stitch regulation modes: Cruise and Precision.

To use Cruise stitch regulation

- Touch the **Regulated** button and then touch the **Cruise** button.

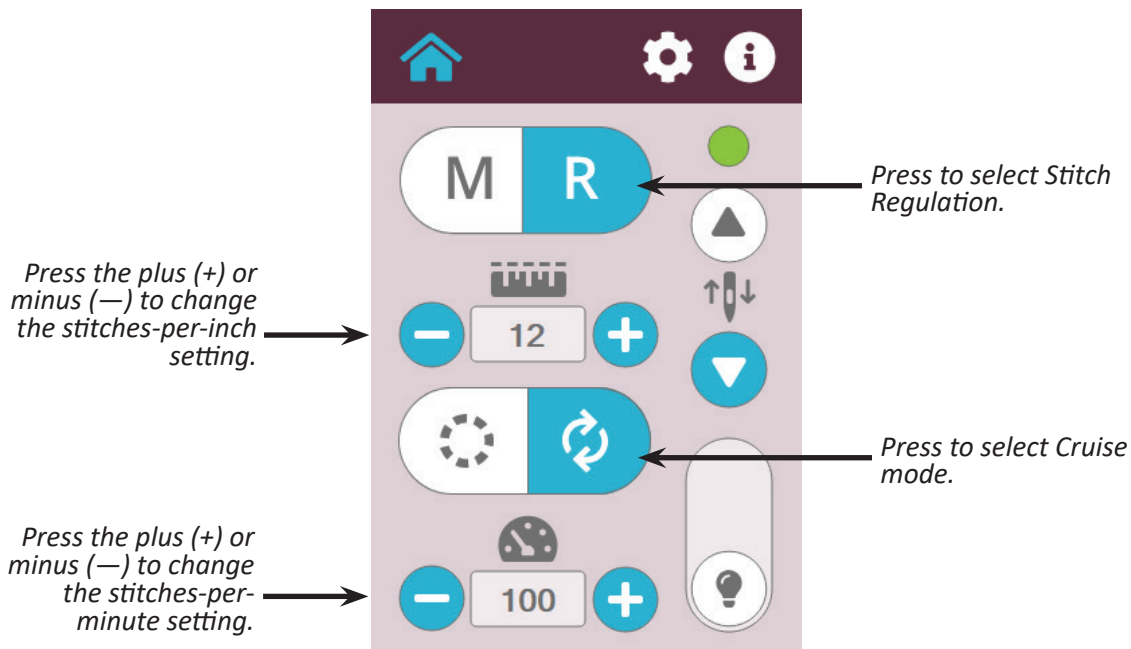

After you press the Start/Stop button on the handlebars, the machine immediately begins quilting according to the stitches-per-minute and stitches-per-inch settings. Similarly, as you bring your quilting to a stop, the needle will continue stitching at the cruise speed (stitches per minute) until you press the stop button on the handlebars. The minimum speed of the needle is dependent upon the stitches-per-minute setting you choose. A setting of 75 is recommend to start at. Begin moving the machine to avoid stitching in place for too long.

Machine Quilting Tip: When to use Cruise stitch regulation

The constant minimum stitching speed featured in the Cruise stitch regulation is useful for precise placement of stitching, such as when backtracking along the tops of feathers or when creating sharp points such as the point of a star or the bottom of a heart.

To use Precision stitch regulation

- Touch the **Regulated** button and then press the **Precision** button.

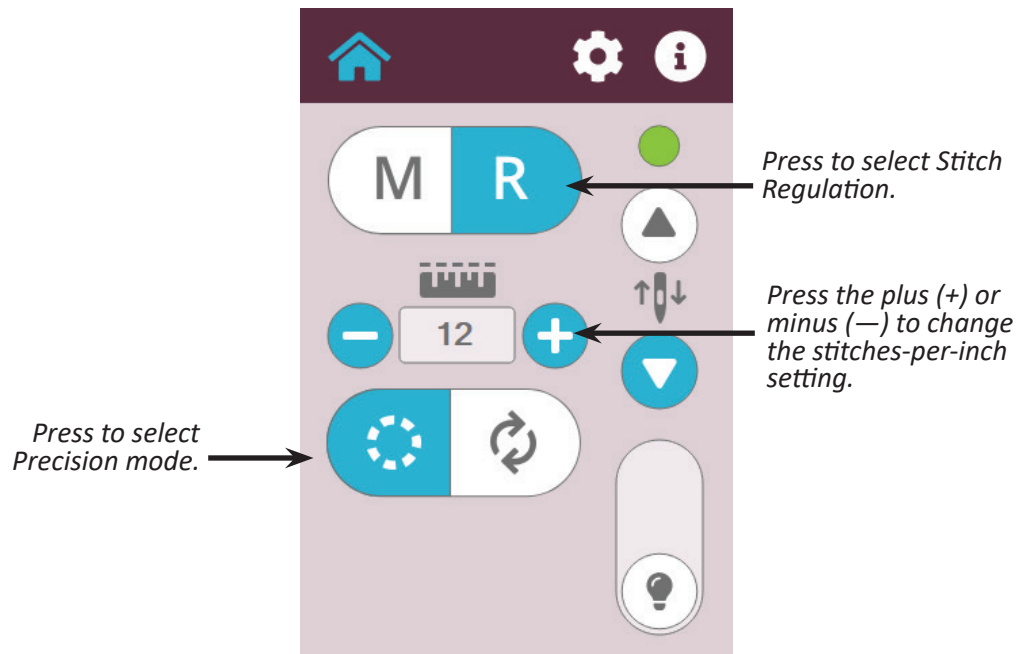

After you press the Start/Stop button on the handlebars, you must begin moving the machine for it to begin quilting according to the stitches-per-inch setting. When you begin moving the machine, stitching begins. When you stop moving the machine, stitching stops but just until you move it again.

 **NOTE:** When using Precision stitch regulation, if you stop moving the machine but do not press the Stop/Stop button, after two minutes it will time out and a message box appears to let you know you will need to press the Start/Stop button to resume quilting.

 **CAUTION:** Always make sure the power is off when changing the needle, replacing the bobbin, or placing your hands near the needle to avoid unwanted stitching in your quilt or in your fingers.

Machine Quilting Tip: When to use Precision stitch regulation

Precision stitch regulation mode is useful for ruler work. Stitch along the length of the ruler for the span of your hand and stop moving the machine, but do not press the Stop button. When you stop moving the machine, the needle pauses. Move the ruler and then begin moving the machine to continue quilting. Precision stitch regulation helps you to avoid bobbles and uneven stitches.

Controlling the Lights

Your Platinum Q|165 comes equipped with an LED light ring.

To control the lights on the machine

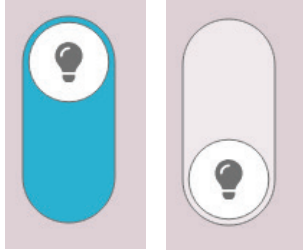

- To toggle the LED light ring on and off, touch the **Lights** button on the Main screen.

When lights are on, the on/off button displays in color. Touch the on/off button to quickly turn off the light.

Machine Tools



To open the machine tools, touch the Tools icon in the toolbar. After selecting it, the icon turns blue. Choose from the tools on the screen.

Opens the on-screen calculator.



Opens the Diagnostics screen.

Opens the Alarms screen.



Opens the Timers screen.

Touch the text bubble icon to alternate among the language options.



Opens the Update screen.

After you select an option, the button background turns to blue and the screen changes for you to do any customization of that setting.

On-Screen Calculator

The Platinum Q|165 includes a basic on-screen calculator. It functions like all basic calculators. For example, press a number button and a function button followed by another number button. Function buttons include addition (+), subtraction (−), multiplication (x), and division (÷). After you've pressed the numbers and the function buttons, press the equal sign (=) for the answer.



- Touch the **Tools** button in the toolbar. Then touch the **Calculator** button. Press the **Home** button to return to the Main screen.

Diagnostics

There are several diagnostics tests that you may be asked to perform by Platinum Q|165 technical support or authorized Platinum Q|165 representatives. These functions test the motion encoders, the motor control functions, the key switches, and the internal position sensors.



- Touch the **Tools** button in the toolbar. Then touch the **Diagnostics** button. Perform diagnostics tests as needed. Press the **Home** button to return to the Main screen.

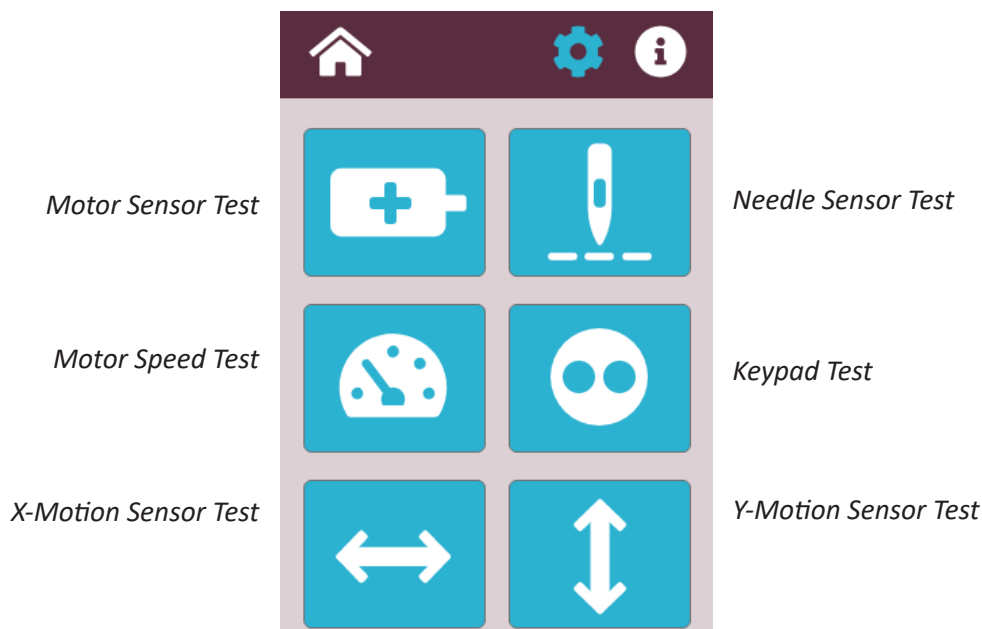

To perform the Motor Sensor Test

The Motor Sensor test helps you determine whether there may be a problem with the Platinum Q|165 motor.

- Press the Motor Sensor Test button. Slowly rotate the hand wheel. While rotating, you should hear an audible pulsing beep. If you get a constant solid beep or no beep at all, the test has failed and the machine should be inspected by a qualified Platinum Q|165 repair technician.

To perform the Needle Sensor Test

The Needle Sensor test indicates whether the needle position sensor is functioning properly.

- Press the Needle Sensor Test button. Rotate the hand wheel. While rotating, you should hear a beep for half of a stitch cycle followed by no beep for the other half. If you hear a constant beep or no beep at all for a full 360° rotation of the handwheel, the test has failed and the machine should be inspected by a qualified Platinum Q|165 repair technician.

To perform the Motor Speed Sensor Test

The Motor Speed Sensor test helps you determine whether or not there is a problem with the Platinum Q|165 speed sensor.

 **NOTE:** Before performing this test, remove the bobbin case and the top thread.

- Press the Motor Speed Sensor button. Then press the Start button on the handlebars and the machine needle will begin slowly moving up and down. The display will show a number that should stabilize at 100 if the sensor is functioning properly. Press Start again to stop the machine and the test.

To perform the Keypad Test

The Keypad test verifies that the Platinum Q|165 is reading the handlebar buttons when they are pressed.

- Press the Keyboard Test button. Then press one of the handlebar buttons. When you press the key, the name of the key appears in a white box on the screen. When you release the key, the name disappears.

To perform the Y-Motion Sensor Test

Use the Y-Motion Sensor test to verify functionality of the Y-axis stitch regulator encoder (the encoder mounted to the rear side of the machine).

- Press the Y-Motion Sensor test button. Slowly move the machine toward and away from you. You should hear a pulsing beep that pulses faster as you move the machine faster. A solid beep, no beep, or periods of irregular beeping (with constant motion) indicate a problem with the Y-axis encoder.
-  **NOTE:** The most likely cause of a problem is a stitch regulator wheel that is not making consistent contact with the track. Check the spring tension on the sensor assembly on the machine to assure that it will easily return to the fully extended (down) position after being compressed. Also assure that the track is straight with no dips or indentations and that it is clean and free of contamination. Other causes are an unplugged or damaged cable or possibly an issue with the main control board.

To perform the X-Motion Sensor Test

Use the X-Motion Sensor test to verify functionality of the X-axis stitch regulator encoder (the encoder mounted at the rear of the carriage).

- Press the X-Motion Sensor test button. Slowly move the machine left and right. You should hear a pulsing beep that pulses faster as you move the carriage faster. A solid beep, no beep, or periods of irregular beeping (with constant motion) indicate a problem with the X-axis encoder.
-  **NOTE:** The most likely cause of a problem is a stitch regulator wheel that is not making consistent contact with the track. Check the spring tension on the sensor assembly on the carriage to ensure that it will easily return to the fully extended position after being compressed. Also ensure that the track is straight with no dips or indentations and that it is clean and free of contamination. Other causes are an unplugged or damaged cable or possibly an issue with the main control board.

Alarms

The Alarms screen has two alarms: the overspeed alarm and the quilting alarm.



- Touch the **Tools** icon in the toolbar. Then touch the **Alarms** button to open the Alarms screen.

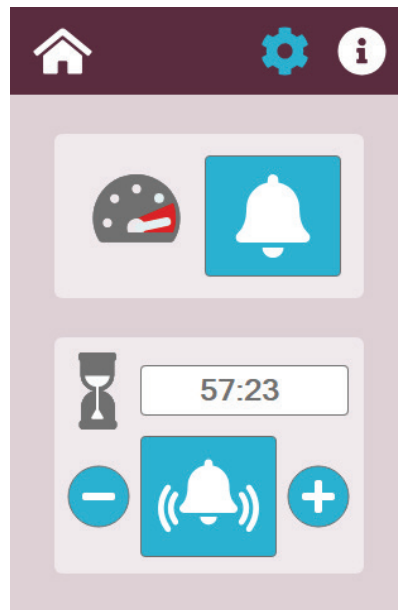

The overspeed alarm alerts you if you are moving the machine faster than 100% of the motor capacity.

The quilting alarm enables you to set timed reminders.

To control the overspeed alarm

The overspeed alarm alerts you if you are moving the machine faster than 100% of the motor capacity and therefore are quilting too fast for stitch regulation to work properly.

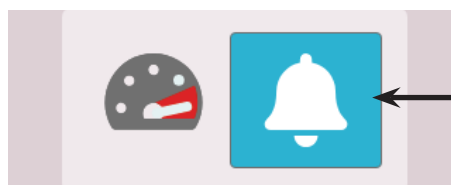

Touch the alarm icon to turn on or off the overspeed alarm. It appears blue when enabled.

1. Touch the alarm button to turn it on or off. It is on when it appears blue. It is off when it appears white.
2. Press the **Home** button to return to the Main screen.

To set the quilting alarm

After you enable the quilting alarm, the time begins to count down. This alarm measures elapsed time, not machine quilting time. The example below shows 57 minutes and 23 seconds are remaining before the alarm will sound.

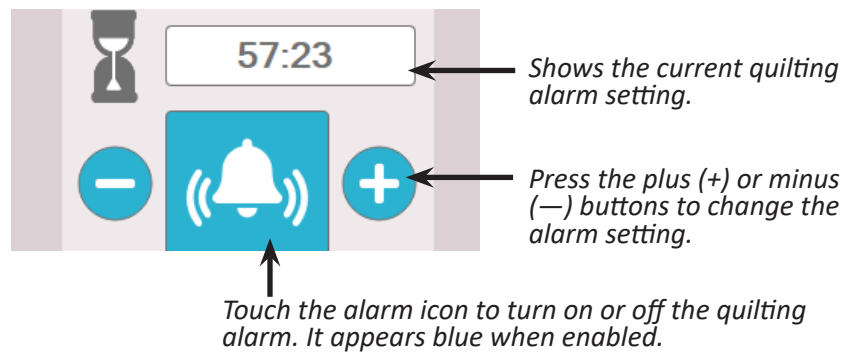

1. Specify the amount of time that will elapse before the alarm will go off. Fine tune the alarm setting by pressing the plus (+) or minus (-) buttons which changes the alarm setting by one minute at a time.
2. Touch the alarm icon to turn on the quilting alarm. When the time has elapsed, an alarm will sound.

Quilt Timer and Stitch Counter

The Timers screen enables you to track the amount of time you work on a quilt and to track the number of stitches on a quilt.



- Touch the **Tools** icon in the toolbar. Then touch the **Timers** button. Press the **Home** button to return to the Main screen.

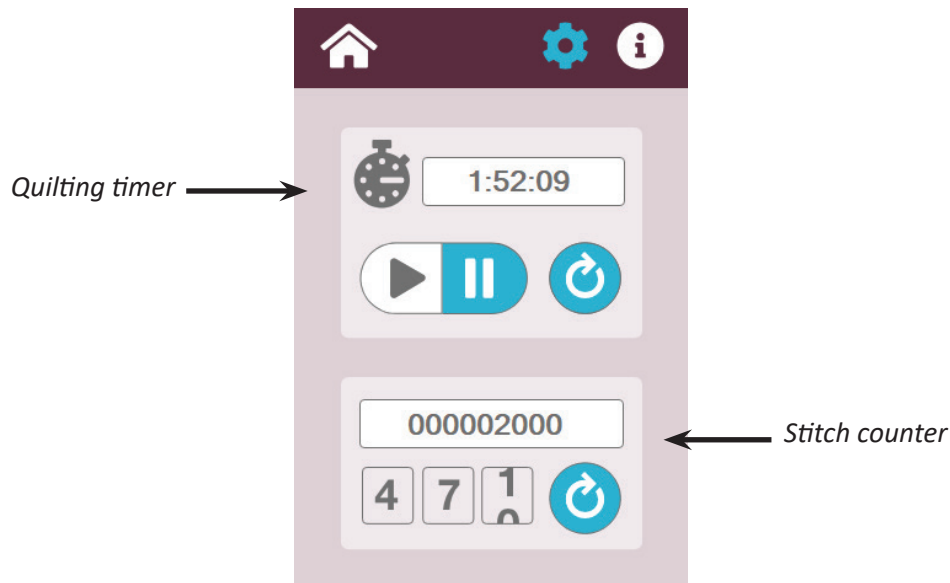

To track how much time you spend on a quilt

Use the quilting timer to keep track of how much time you spend on a quilt. The quilting timer measures time the machine is actually quilting, not the time the machine is on but not stitching.

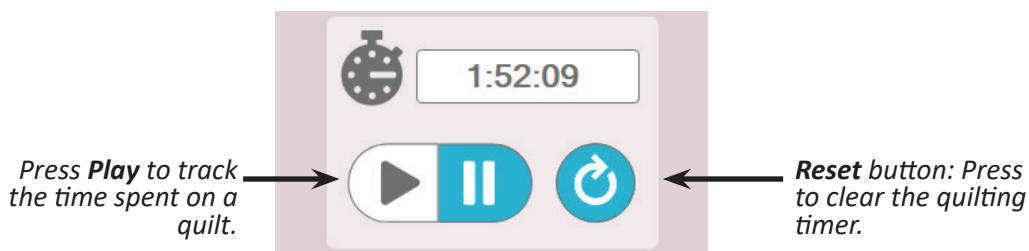

1. When you begin a new quilt, press **Reset**.
2. When you are ready to begin tracking the time spent on a quilt, press **Play**. Proceed with your quilting. When you are through quilting for a time, press **Pause**.
3. When you resume quilting, press **Play** again. The quilting timer will continue tracking your time and add it to the previously recorded time.

To track the number of stitches in a quilt

Use the stitch counter to count the number of stitches in a quilt.

- Press the **Reset** button to zero-out the counter when you begin a new quilt. To see the lifetime stitch counter for your machine, see the *Information screen*.

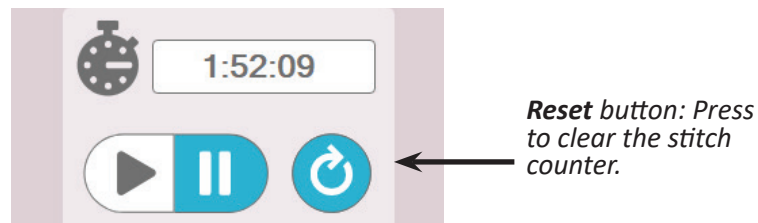

Set Language

The language setting determines the language used on the Platinum Q|165 information screens. The choices are English, French, German, and Spanish.

To select a language

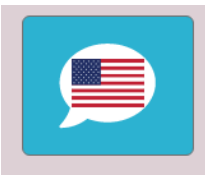

1. Touch the **Tools** icon in the toolbar. The Tools screen appears.
2. Press the language image to rotate through the language options: English, French (Français), German (Deutsch), and Spanish (Español).
3. When the button representing the language you want to use appears, press the **Home** button to return to the Main screen.

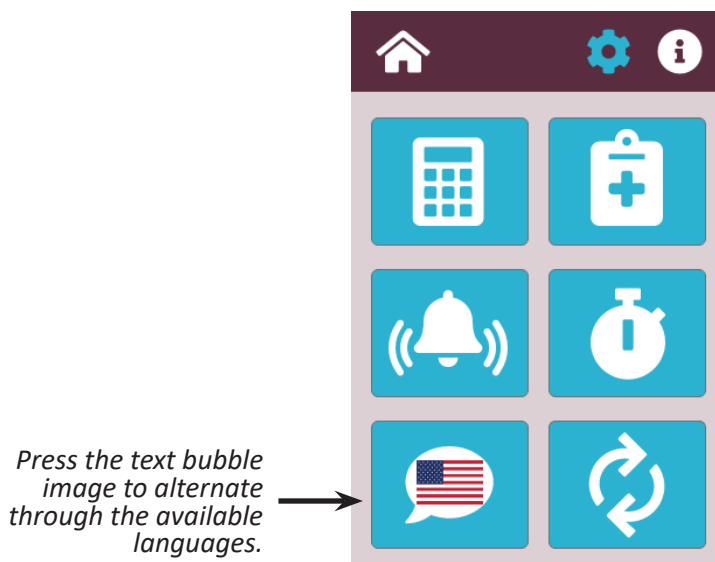

Updating Machine Software

From time to time the Husqvarna Viking® brand releases software updates for the Platinum Q|165 quilt machine. This update feature enables you to take advantage of the latest software capabilities added to machines. When an update is released, download the updated file(s) to a USB drive using a computer that is connected to the Internet. You will usually need to download two files: one for the machine software and one for the display software. Make a note of the filenames and which is for the machine and which is for the display.

 **NOTE:** Save the file(s) to the root directory of the USB drive. (This means that they are not stored in a subdirectory on the drive; they are in the main, or root, directory.)

After downloading the updated software to a USB drive, insert the drive into the USB port on the right side of the display. The arrow will flash until the USB drive is fully inserted. The display changes to show the USB inserted into the machine. If the image doesn't change, remove and insert the USB drive again. Then touch either the Machine or Display button depending on which software you want to update.



- Touch the **Tools** icon in the toolbar. Then touch the **Update** button. Press the **Home** button to return to the Main screen.

To update the machine's software

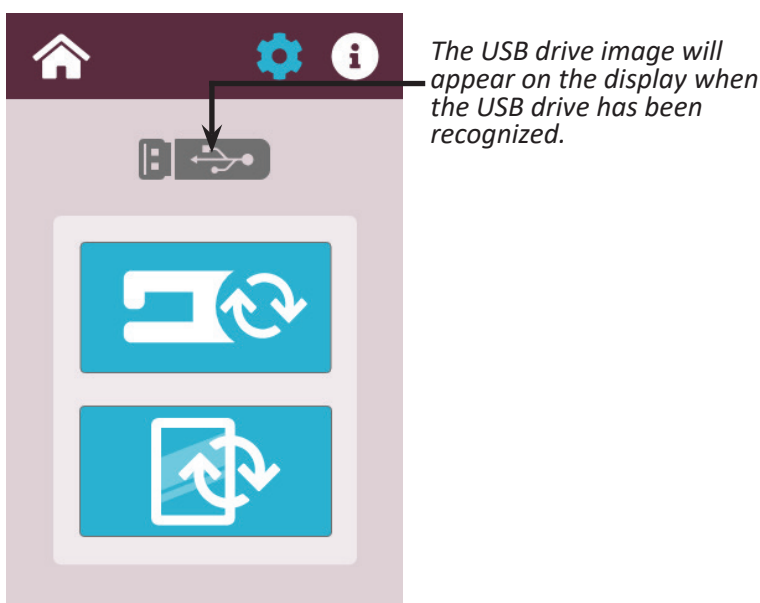

 **IMPORTANT:** If you have installed the optional rear handlebars, temporarily unplug the rear handlebars while you update the machine software. Plug in the rear handlebars again when the update is complete.

1. Insert the USB drive into the USB port on the right side of the front display. Then touch the Machine icon on the screen to update the machine's software. The button will remain blue until the update is completed.



2. The Platinum Q|165 will search for the machine update file on the USB drive. When the update is complete, the Machine button turns from blue back to white.

To update the front display's software

1. Insert the USB drive into the USB port on the right side of the front display. Then touch the Display icon on the screen to update the display software. The button will remain blue until the update is completed.



2. The Platinum Q|165 will search for the display update file on the USB drive. When the update is complete, the Main screen appears on the display.

 **NOTE:** If you do not have the optional rear handlebars, you will hear three beeps while the front display is updating.

To update the optional rear display's software

If you have a the optional rear handlebars and display, you will need to update the rear display as well.

- To update the rear display, insert the USB into the port on the right side the rear display and run the display update feature from the rear display.

Information Screen



To open the information screen, touch the **Information** icon in the toolbar. After selecting it, the icon turns blue. Choose from the information options on the screen.

To monitor system information about your machine

You may need to provide system information to Husqvarna Viking® customer service or an authorized Husqvarna Viking® dealer when purchasing machine accessories or receiving technical assistance.

- Touch the **Information** icon in the toolbar.

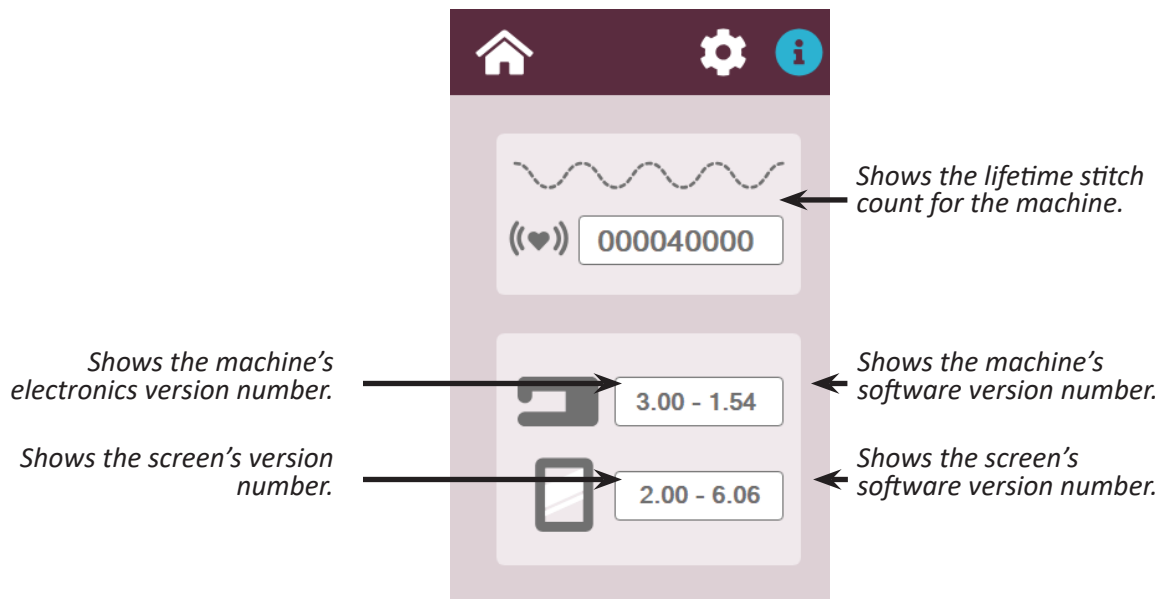

Machine Maintenance

Clean and Oil Your Platinum Q|165

The only place where you need to regularly oil your machine is the bobbin hook assembly. Failure to keep the hook assembly lubricated can cause severe damage to the machine. We recommend that you oil the hook assembly with each bobbin change and before use if you haven't used the machine for a few days. A change in the sound of the machine while quilting also indicates that it may need to be oiled.

 **NOTE:** Internal oiling needs to be done when the machine is taken to a service technician for routine maintenance and cleaning, every 12 to 24 months, depending on use.

 **IMPORTANT:** Only use light sewing machine oil in the hook when oiling your machine.

To clean the bobbin area and oil the bobbin hook

1. Turn off the machine. Then remove the bobbin and bobbin case.
2. Clean the bobbin basket and hook assembly with a soft brush to remove lint.
3. Put a small drop of oil on the hook in the region where the bobbin basket assembly and the rotating hook meet. The oil will work its way back into the interlocking area of the hook and bobbin basket.

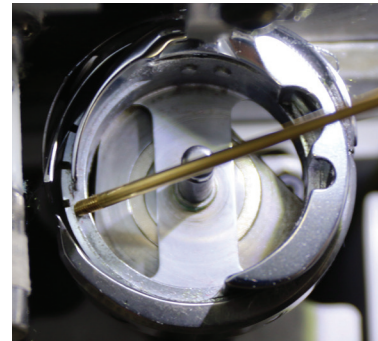

4. Replace the bobbin and bobbin case and turn on the machine.

Machine Quilting Tip: After oiling your machine

After oiling, always sew on a scrap piece of fabric off to the side of the quilt as oil may cling to thread. Over oiling can cause excess dripping from the bobbin assembly.

 **IMPORTANT:** How often you lubricate your machine depends upon how much use it gets. We recommend that you lubricate it before running the machine if it has not been used regularly, or after every bobbin change when using regularly. Failure to keep the machine lubricated will affect stitch quality and may result in a change in the sound of the machine.

To clean the touch-screen display

- Use a soft rag or microfiber cloth dampened with isopropyl alcohol and then gently wipe the display to remove any dust or fingerprints.

 **CAUTION:** Never use any chemicals to clean your display as this may negatively affect the display's touch-screen response.

Maintenance Schedule

In addition to the ongoing cleaning and oiling maintenance, you should have your machine serviced by an authorized Husqvarna Viking® service technician every 12 to 24 months, depending on use. They will take care of oiling and greasing internal parts and ensure the machine is in tip-top working order.

Troubleshooting

You can correct many problems on your own. If you need additional help, contact your local, authorized Platinum Q|165 retailer.

First check the following:

1. The AC power cord is properly connected and the power switch is turned on.
2. Confirm that all cables are properly seated into their connections.
3. Turn off the machine completely. Wait for at least ten seconds and then turn it back on.

If the above checks did not solve the problem, refer to the information below.

Skipped Stitches	Corrective Measure(s)
The needle is damaged, dull, bent, or installed improperly	<ul style="list-style-type: none">• Replace the needle regularly, at least once per quilt. Use only the recommended needle system.• Always change the needle if the needle has struck any hard object such as a straight pin, etc. The tip of the needle can become damaged or burred, resulting in fabric damage as well as skipped stitches, thread breakage, or shredding.• Always change the needle if it has been hit, bumped or pulled off center while maneuvering the machine about the quilt. A slightly bent needle can be a major cause of skipped stitches.
Incorrect needle size	<ul style="list-style-type: none">• Use the proper size of needle for the work and thread being used. Some battings and fabrics used in quilting may constrict or impede the thread passing through the front groove of the needle. This diminishes the loop lift required for stitch formation. Typically, a larger needle will solve the problem. However, using certain smaller sizes of needles and ball pointed needles solve some specific problems. You will need to experiment to determine which work best with your combination of fabric, thread, and batting.
Fabric is too tight on the frame	<ul style="list-style-type: none">• Loosen the pole tension on the frame. Fabric that is rolled too tightly causes the fibers to separate and the fabric to bounce while quilting. This reduces the needle friction on the thread, resulting in a smaller thread loop or skipped stitches.
Thread tension too tight	<ul style="list-style-type: none">• Check bobbin case tension and then check top thread tension. (For more information about adjusting tension, see <i>Bobbin and Bobbin Tension</i> and <i>Top Thread Tension</i> in the <i>Using Your Machine</i> section of this manual.)

The needle is not positioned properly	<ul style="list-style-type: none"> Position the needle properly to the needle bar. Inspect the position of the needle to make sure the needle is at the 6 o'clock position. When you stand directly in front of the needle (facing the bobbin case side of the machine), you will see the entire needle eye directly facing you. This is 6 o'clock position. Make sure (a) the needle is installed all the way into the needle bar to the needle-stop hole in the needle bar, (b) the long groove in the needle is toward the front (bobbin case side), and (c) the scarf (scooped out part of the back of the needle) is toward the back of the machine. The needle can sometimes be rotated to 5 o'clock (slightly right) or 7 o'clock (slightly left) to adjust for a more positive thread loop pickup by the hook point.
Improper threading	<ul style="list-style-type: none"> Ensure that the machine is threaded correctly.
The Needle Breaks	Corrective Measure(s)
The needle is bent or not installed properly	<ul style="list-style-type: none"> Replace the needle. Make sure that the needle is pushed into the needle bar clamp until it can go no farther. Visually check that it is up to the top of the stop/sight hole above the needle bar clamp screw. If the needle isn't installed properly, it can cause damage in the bobbin area and needle plate.
The needle hits the needle plate	<ul style="list-style-type: none"> Correctly position the needle, needle plate, or hopping foot. Replace with a new needle.
Stitches are Puckered	Corrective Measure(s)
The tension is not balanced. Top and bottom tension are both too tight.	<ul style="list-style-type: none"> Balance the tension of the needle thread after ensuring the bobbin tension is adjusted correctly. (For more information about adjusting tension, see <i>Bobbin and Bobbin Tension</i> and <i>Top Thread Tension</i> in the <i>Using Your Machine</i> section of this manual.)
Needle too large for quilting fabric	<ul style="list-style-type: none"> Replace the needle with a size better suited for the fabric.
Poor Stitch Quality	Corrective Measure(s)
The tension is not balanced	<ul style="list-style-type: none"> Balance the tension of the needle thread after ensuring the bobbin tension is adjusted correctly. (For more information about adjusting tension, see <i>Bobbin and Bobbin Tension</i> and <i>Top Thread Tension</i> in the <i>Using Your Machine</i> section of this manual.)

Bobbin case is damaged, corroded, dirty, etc.	<ul style="list-style-type: none"> • Since thread slides over the surface of the bobbin case at a high speed, make sure the case is free of any lint or foreign matter that could impede thread passage through the machine.
Moving the machine too fast for needle speed selected (Manual mode)	<ul style="list-style-type: none"> • Synchronize machine movement and needle speed to get roughly 8 to 10 stitches per inch. Elongated stitches are an indication of moving the machine too fast for the current speed.
Tension is Poor	Corrective Measure(s)
Lint caught under the tension spring in the bobbin	<ul style="list-style-type: none"> • If using short staple threads, inexpensive, or industrial threads, or coated threads, lint and other material will build up under the tension spring and begin to lift the spring, reducing the spring's ability to compress against the thread. Insert a needle or business card under the spring and clear out the lint. The bobbin tension will return fairly close to its preset tension. Test the tension before quilting.
Hand Wheel Won't Rotate	Corrective Measure(s)
Thread is entangled and caught in the hook	<ul style="list-style-type: none"> • Turn off the machine and unplug the machine from the electrical outlet. Lubricate the hook, strongly turn the hand wheel clockwise and if necessary counterclockwise several times, and then remove the thread caught in the hook.
Thread Nests Under Quilt	Corrective Measure(s)
Not enough tension on top thread	<ul style="list-style-type: none"> • Check that the machine is threaded correctly. Make certain that the thread is flossed snugly in place between the two tension discs. If the machine is threaded correctly, tighten top tension by rotating the tension knob clockwise. (For more information about adjusting tension, see <i>Bobbin and Bobbin Tension</i> and <i>Top Thread Tension</i> in the <i>Using Your Machine</i> section of this manual.)
Improper threading	<ul style="list-style-type: none"> • Refer to threading diagram and threading instructions.
Hard to Guide Machine	Corrective Measure(s)
Carriage wheels not centered on track	<ul style="list-style-type: none"> • Center the carriage wheels on top of the continuous track. Check that the machine carriage has not jumped the track.
Thread caught in wheels	<ul style="list-style-type: none"> • Remove all thread or debris in wheels. Check that the tracks are free of lint and threads.
Motor Fails to Run	Corrective Measure(s)
On/Off switch turned off	<ul style="list-style-type: none"> • Turn the machine on by using the switch on the back.
Machine not receiving power	<ul style="list-style-type: none"> • Check that the power connector is securely plugged into the back of the machine and the three-prong end is plugged into the power source.

Thread Breaks	Corrective Measure(s)
Thread is poor quality or may have severe twisting or thread rot	<ul style="list-style-type: none"> Look for severe twisting of threads when approximately 12 to 15 inches has been pulled off, with the ends pinched together. Cotton threads are particularly susceptible to dry rot or wet rot which makes thread brittle. Do not use poor quality thread, or thread that is rotted or brittle.
Top and bobbin tensions not balanced	<ul style="list-style-type: none"> Balance the tension of the needle thread after ensuring the bobbin tension is adjusted correctly. (For more information about adjusting tension, see <i>Bobbin and Bobbin Tension</i> and <i>Top Thread Tension</i> in the <i>Using Your Machine</i> section of this manual.)
The machine head has been threaded incorrectly or thread spools are not positioned correctly	<ul style="list-style-type: none"> Check that the machine is threaded correctly. Inspect for accidental double wrapping of thread on thread guides. Inspect the thread mast, making sure the eyelets of the mast are directly over the spools. Inspect the vertical positioning of the thread cones. Tipped cones can dramatically affect thread tension and can cause breakage.
Debris in tension discs	<ul style="list-style-type: none"> Inspect for particles and remove any fuzz or debris.
Bobbin rotation is not smooth	<ul style="list-style-type: none"> Change the bobbin. The slightest hesitation of the bobbin rotation can be the cause of dramatic tension change and thread breakage.
Needle is burred, bent or dull, or installed incorrectly	<ul style="list-style-type: none"> Change the needle at least once per quilt. Make sure the needle is installed to the top of the stop hole in the needle bar.
Needle not suitable for thread	<ul style="list-style-type: none"> Replace the needle to one better suited for the thread. Use the proper size needle.
Hesitating too long at one point in quilting motif	<ul style="list-style-type: none"> Move more quickly so stitches don't overlap or build up. When starting the machine, begin moving immediately. Sewing in one place too long will cause the thread to break.
Improper needle/hook relationship	<ul style="list-style-type: none"> Machine timing needs to be checked. Consult an authorized Husqvarna Viking® technician.
Damage or burr at needle hole of needle plate or other thread handling part	<ul style="list-style-type: none"> If thread is shredding at the needle plate, check for burrs or jagged edges. Gently rub with metal cloth to remove the sharp edge. Consult a repair technician to polish any hard-to-reach or delicate areas, or if the burr is inside the throat.

Wrong type of needle	<ul style="list-style-type: none"> • Use only the needles recommended by Platinum Q 165: 134 (135x7) sizes 12 through 20.
Other possible problems	<ul style="list-style-type: none"> • Needle too close to hook, causing friction and possible collision of hook point and needle (causing broken thread). • Needle plate damage • Hook damage • Broken needles or damaged needle bar clamp
Nothing visible on the display	Corrective Measure(s)
Display cables unplugged	<ul style="list-style-type: none"> • Locate the black cables that plug into the touch-screen display and connect to the side of the machine. Make sure both ends are plugged in securely.

 **NOTE:** If the troubleshooting tips do not eliminate the problem, please consult an authorized Husqvarna Viking® representative.

Appendix 1

Federal Communications Commissions (FCC) Declaration of Conformity (For USA Only)

Responsible Party: SVP Worldwide
1714 Heil Quaker Blvd Suite 130
Vergne, TN 37086

declares that the product

Product Name: Platinum Q|165

complies with Part 15 of the FCC Rules. Operation is subject to the following two conditions: (1) this device may not cause harmful interference, and (2) this device must accept any interference received, including interference that may cause undesired operation.

This equipment has been tested and found to comply with the limits for Class B digital device, pursuant to Part 15 of the FCC Rules. These limits are designed to provide reasonable protection against harmful interference in a residential installation. This equipment generates, uses, and can radiate radio frequency energy and, if not installed and used in accordance with the instructions, may cause harmful interference to radio communications. However, there is no guarantee that interference will not occur in a particular installation.

If this equipment does cause harmful interference to radio or television reception, which can be determined by turning the equipment off and on, the user is encouraged to try to correct the interference by one or more of the following measures:

- Reorient or relocate the receiving antenna.
- Increase the separation between the equipment and receiver.
- Consult the dealer or an experienced radio/TV technician for help.

Changes or modifications not expressly approved by the manufacturer or local sales distributor could void the user's authority to operate the equipment.

Canadian Department of Communications Compliance Statement (For Canada Only)

This digital apparatus does not exceed the Class B limits for radio noise emission from digital apparatus as set out in the interference-causing equipment standard entitled "Digital Apparatus", ICES-003 of the Department of Communications.

Radio Interference (Other than USA and Canada)

This machine complies with EN55022 (CISPR Publication 22) /Class B and AUS/NZ 55022/Class B.

This page was intentionally left blank.

This page was intentionally left blank.



www.husqvarnaviking.com