

# Elvira

By Angela Walters



## QuiltingIsMyTherapy.com

# Continuous Curves with Elvira

Needle stops ensure easy placement of the ruler.

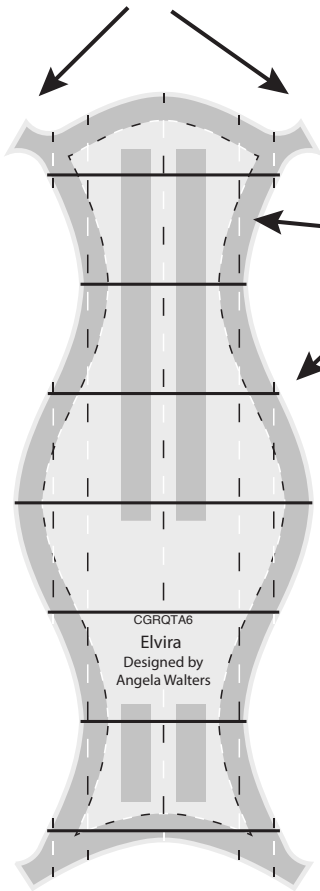

Vertical and horizontal reference lines will help position the ruler on the quilt block.

## About Elvira



CGRQTAB  
Elvira  
Designed by  
Angela Walters

# 1

Position the ruler so that it is snug against the foot of the machine. Ensure that the dashed reference lines are lined along the seams on both sides of the block. If the block isn't exactly 2", position the center dashed line so that it is in the center. Quilt along the top of the ruler to the next point of the block.

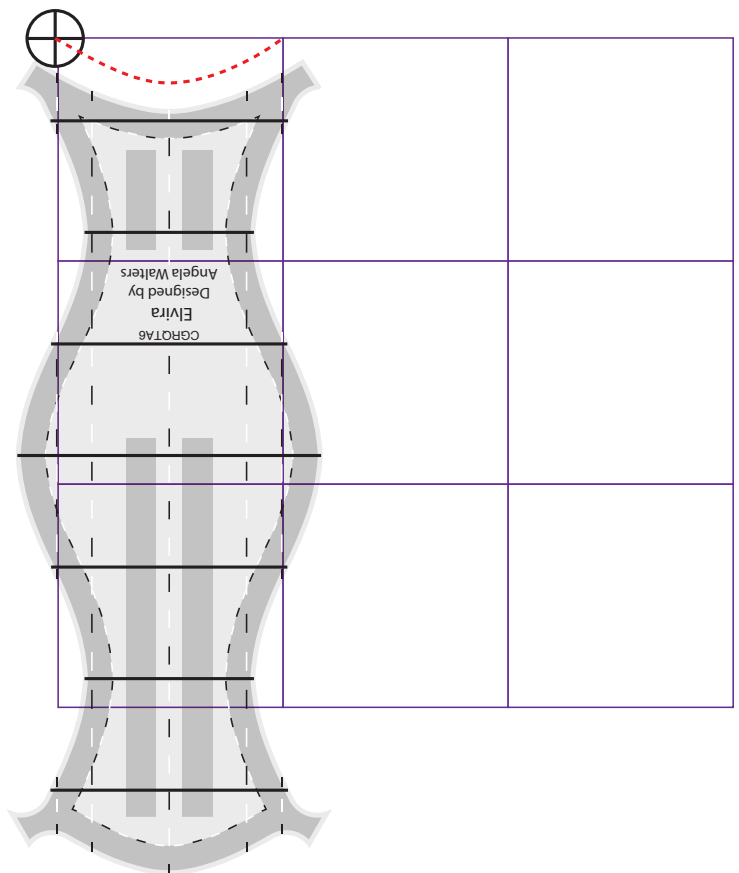

# Elvira

By Angela Walters

Turn-a-Round™  
**creative grids**  
The Original NON-SLIP Ruler

## QuiltingIsMyTherapy.com

### Continuous Curves with Elvira

# 2

Reposition the ruler so that the needle stop is snug against the foot. Check to see if the horizontal reference lines on the ruler are lined up with the seams of the block.

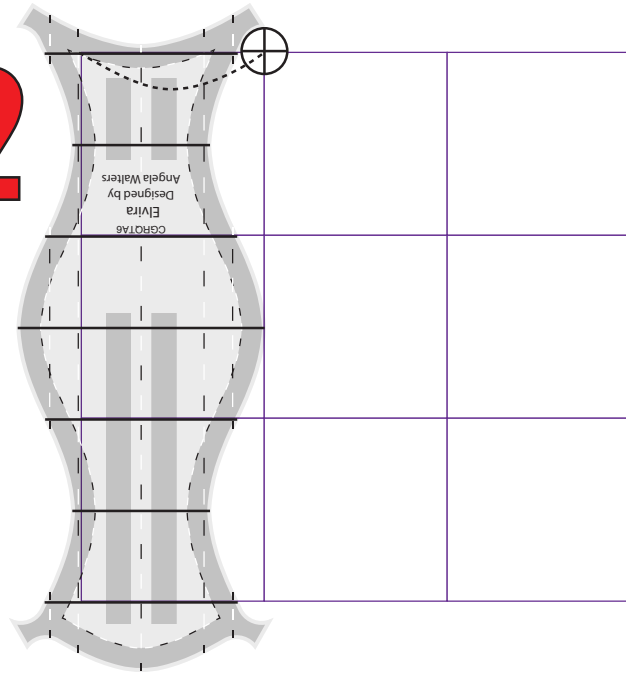

# 3

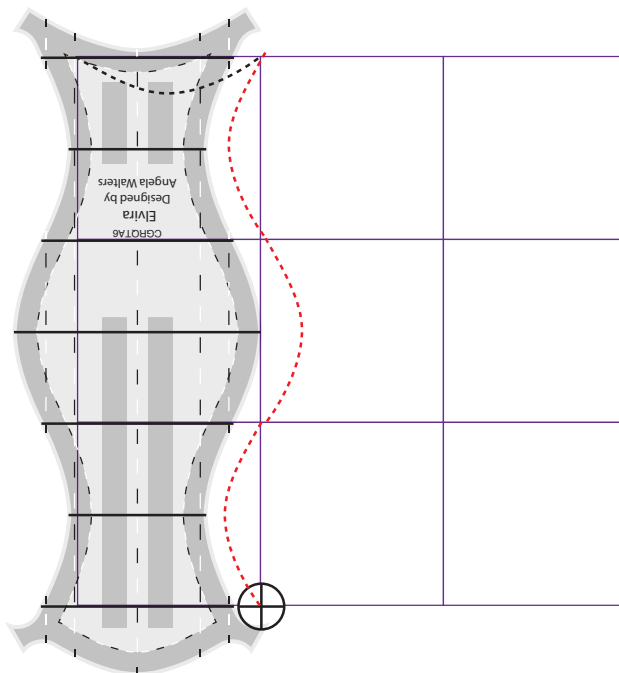

Quilt along the ruler. As you go from point to point, ensure that the reference lines are still on the seams of the block.

### Continuous Curves with Elvira

# 4

To quilt back to the starting point, slide the ruler up so that 3rd horizontal reference line is lined up with the bottom seam. Check that the vertical reference line is also lined up on top of the left seam.

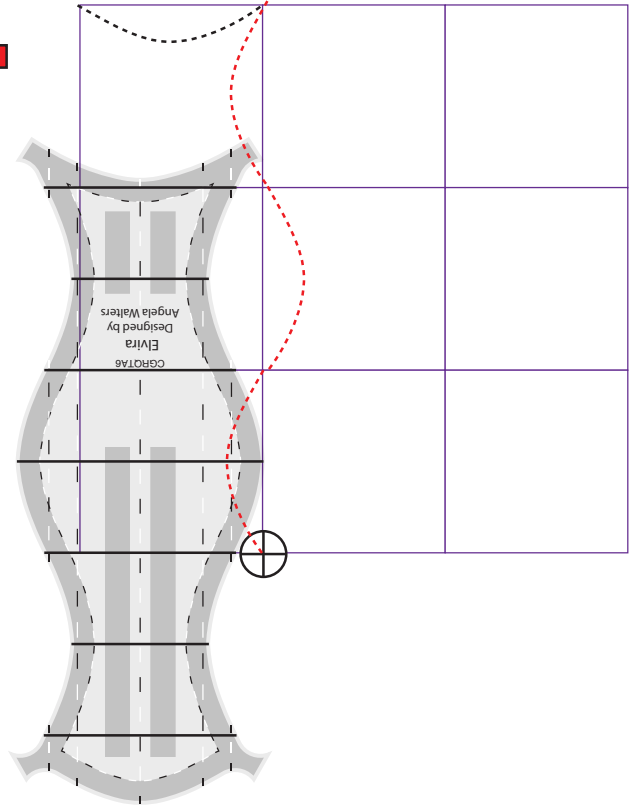

# 5

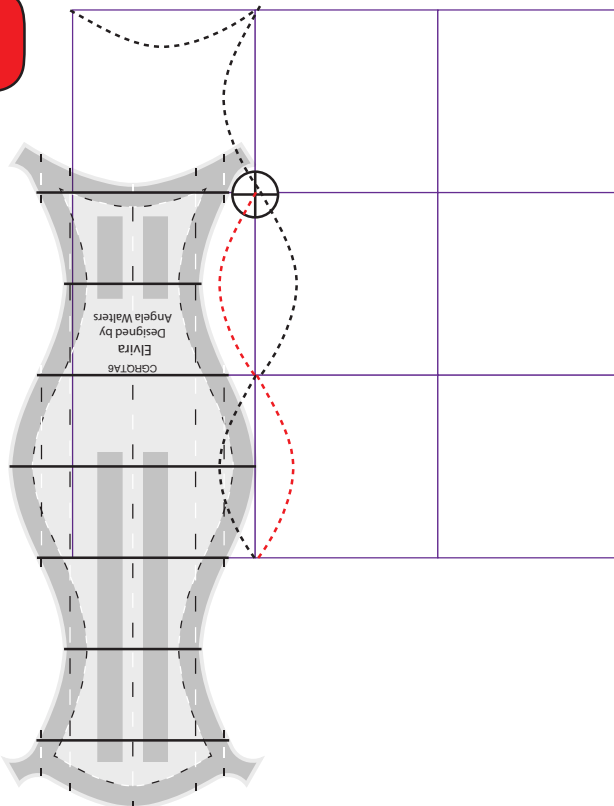

Quilt along the ruler until you reach the needle stop at the end.

### Continuous Curves with Elvira

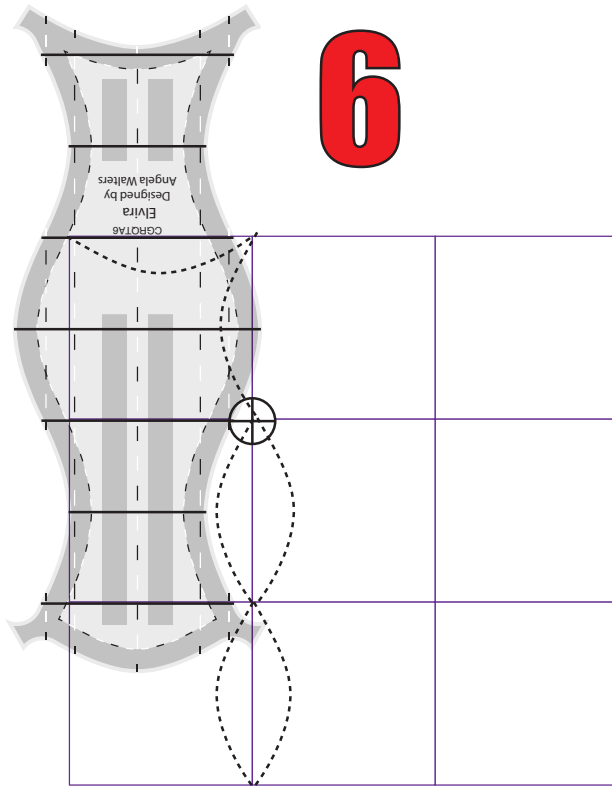

Reposition the ruler by sliding the ruler up until the 3rd horizontal reference line is on the same seam as the needle.

# 7

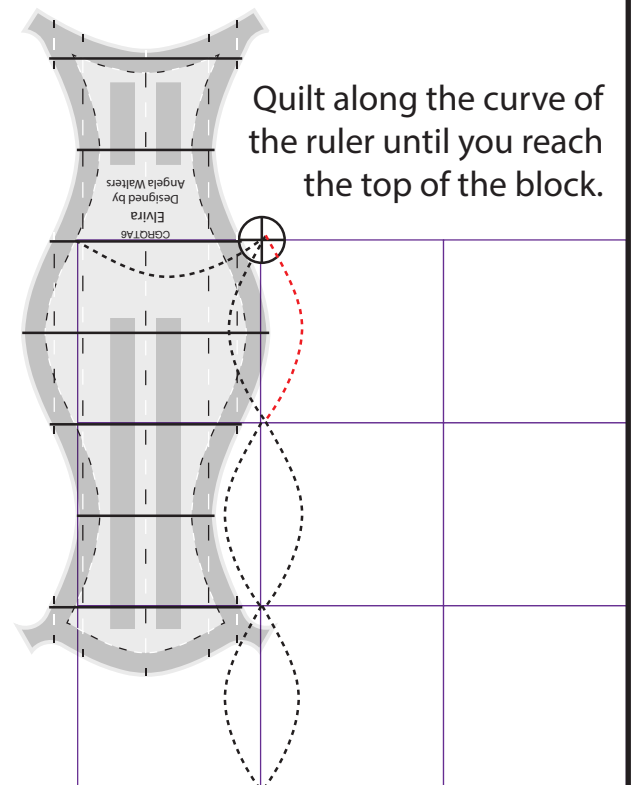

Quilt along the curve of the ruler until you reach the top of the block.

### Note:

If quilting continuous curves in a block larger than the ruler, just reposition the ruler when you get to the needle stop, just as in Step 6.

# 8

Repeat Steps 1-7 to quilt the next vertical row of continuous curves.

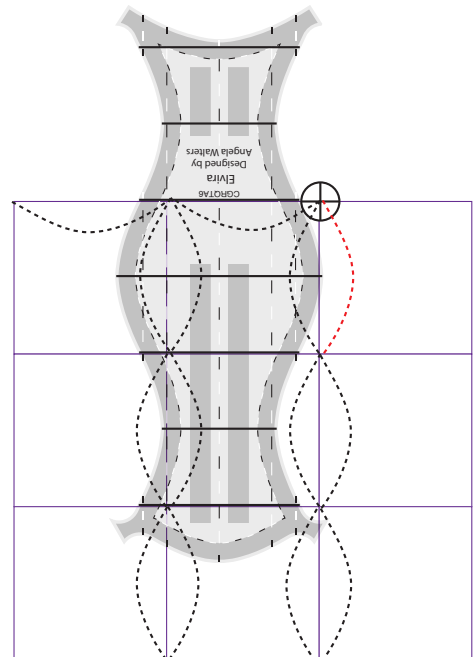
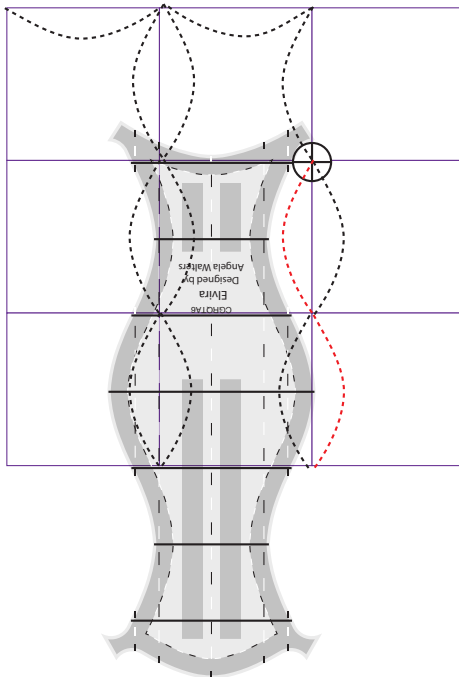
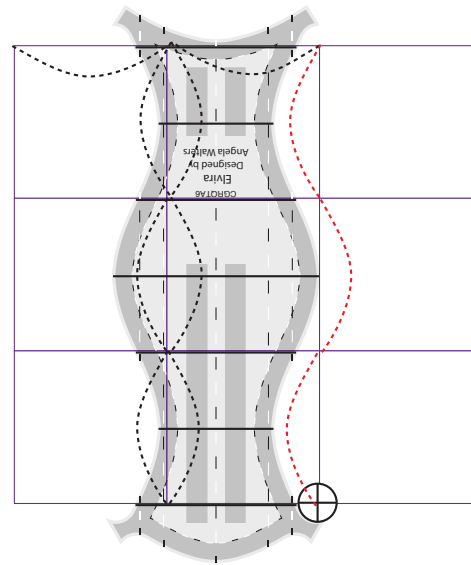
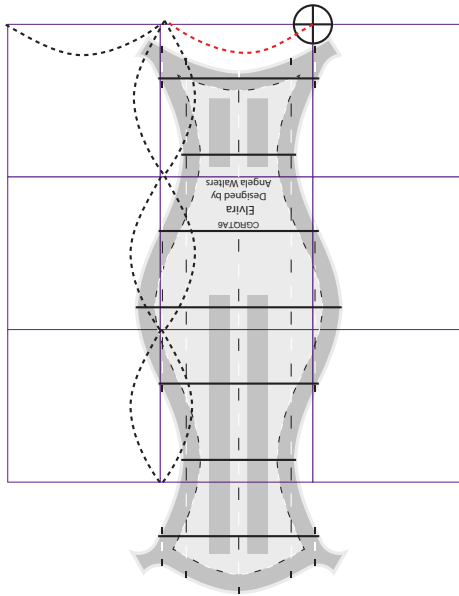

Continuous Curves with Elvira

### Continuous Curves with Elvira

# 9

Quilt a curve to the next corner, Then reposition the ruler to quilt a curve to then next seam line.

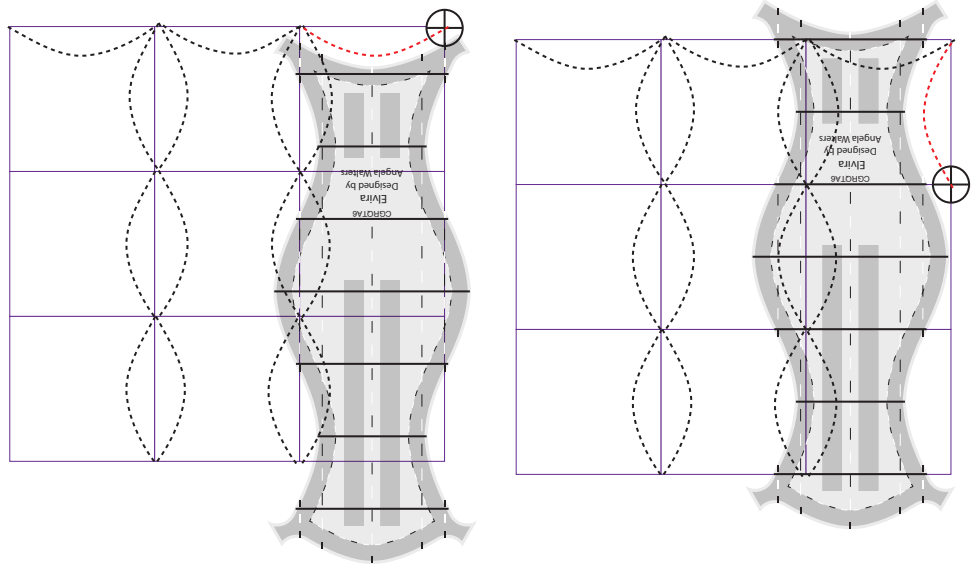

# 10

Reposition the ruler so that it is horizontal. Ensure that the reference lines are lined up with the seams, the quilt along the edge of the ruler.

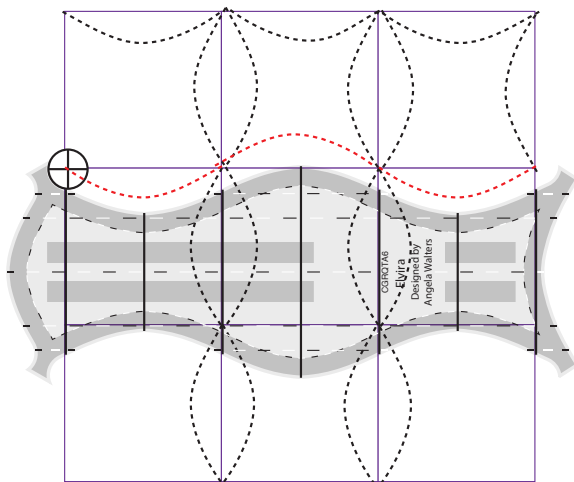

# 11

Slide the ruler to the left so that the third reference line is lined up on the seam that the needle is on. Quilt along the edge of the ruler until you get to the needle stop.

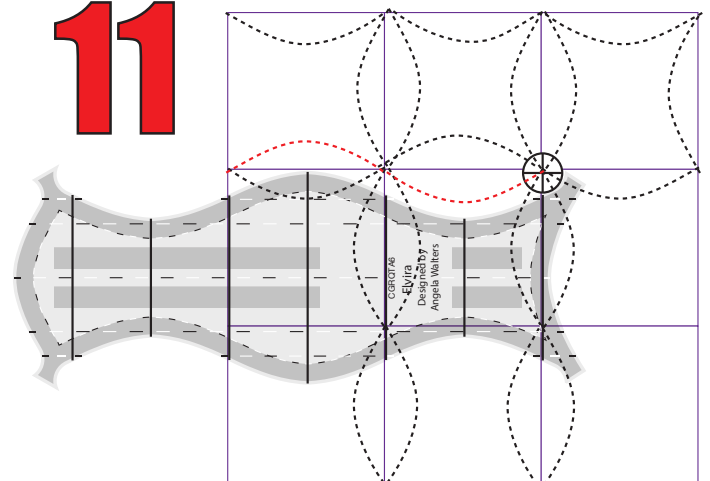

# Elvira

By Angela Walters



## QuiltingIsMyTherapy.com

# Continuous Curves with Elvira

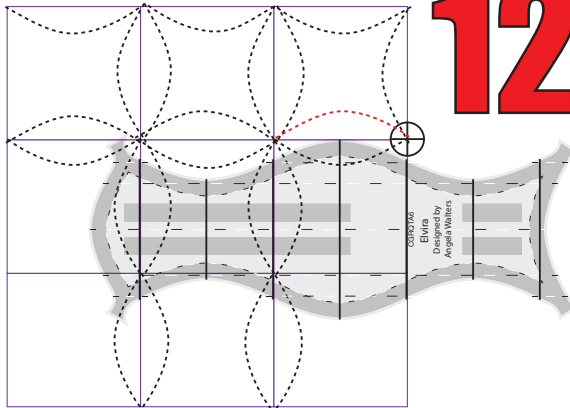

Slide the ruler to the right so that the third reference line is lined up with the seam and quilt another curve.

Repeat until the whole block is quilted.

# 13

