

NON-SLIP Quick Trim & Circle Ruler XL

This ruler is designed to cut any 45° angle and include the seam allowance. It will also draw circles in ½" increments from 1" to 46".

Designed by Rachel Cross & Karen Montgomery

#CGRMT5
 Made in USA



SEE A DEMO
 SCAN WITH ANY
 QR READER



CGRMT5

743285001859

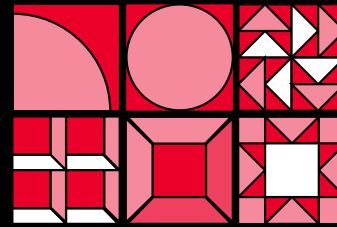

Creative Grids® USA, Inc.
 400 W. Dussel Dr. Ste B,
 Maumee, OH 43537
 www.creativegridsUSA.com

Creative Grids® UK, Ltd.
 Unit 23A Pate Road
 Leicester Road Industrial Estate
 Melton Mowbray
 Leicestershire, LE13 0RG England
 www.creativegrids.com

NON-SLIP Quick Trim & Circle Ruler XL

This 4 ½" x 24 ½" Quick Trim and Circle Ruler includes the Turn Around™ feature as well as all of the markings of a traditional Creative Grids® ruler. It also has 45° angles, which are positioned to eliminate the need to draw your stitching lines on 45° seams. These perfectly positioned 45° angles allow you to add an exact ¼" seam allowance to flying geese blocks and half square triangles so that you trim before you sew. The angle lines will also help in pre-trimming binding strips for perfectly stitched angles. Use the holes drilled in the center of the ruler to draw circles from 1" to 46" in diameter - and every ½" in between.

Drawing a circle

1. Fold the fabric in fourths to find the center of the fabric. Mark the center with your favorite marking tool and unfold the fabric. Determine the diameter of the circle you would like to draw. Divide the diameter by two to find the radius. Turn your Quick Trim Ruler upside down so that the non-slip surface is on top. This will allow your ruler to move smoothly as you rotate it to draw the circle.

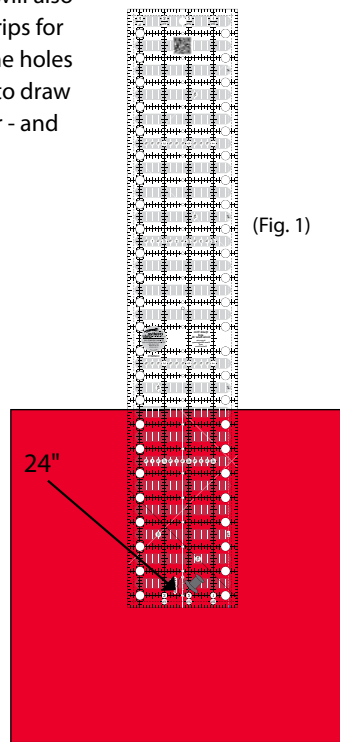

(Fig. 1)

2. Position the ruler hole at the 24" mark over the center mark on your fabric. Place a push pin into that hole and into your fabric. (Fig. 1) This will be your pivot point. Manually count the inch increments equal to the radius of your desired circle, and insert the marking tool into that hole. In this example, the finished circle measures 10". The pin was placed at the 24" marking and the marking tool in the hole 5" away from the pin (19"). (Note: Every inch increases the diameter of the circle by two inches). (Fig. 2)

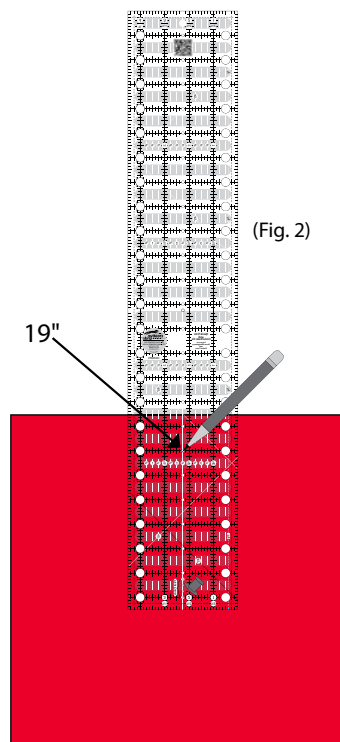

(Fig. 2)

3. Hold the pin in place as you rotate the ruler around the pin to draw the circle. (Fig. 3)

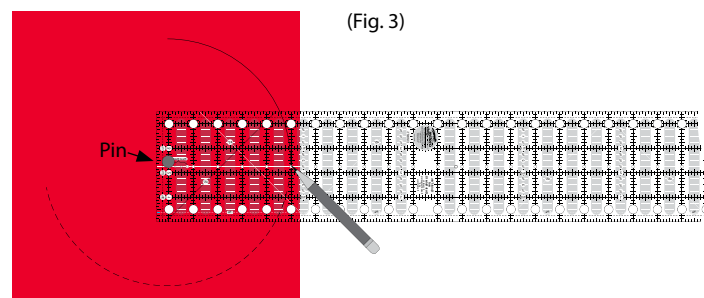

(Fig. 3)

4. If the diameter of your circle is an odd number, you must use the pivot points that are drilled at the end of the ruler. Position your pin in the hole at the ½" point, located at the 23½" mark on the ruler and count the remaining distance to the proper hole for the radius of your circle. For example: Placing your pin in the pivot point at the ½" mark and counting 3 full inches away will allow you to draw a 7" circle. Adjust your pin in the pivot points to fit the radius of your desired circle up to 46".

Cutting Half-Square Triangles

1. Layer the fabric strips right sides together. Straighten the end of the strips. In this example, the finished half-square triangles measure 4", the fabric strips are cut 4½" (Cut your fabric strip ½" wider than the finished size of the half-square triangles you desire). Line up the 45° angles on the ruler with the side and top of the strip as shown in (Fig. 1). Cut along the diagonal. The ruler measures the angle and includes the seam allowance for you.

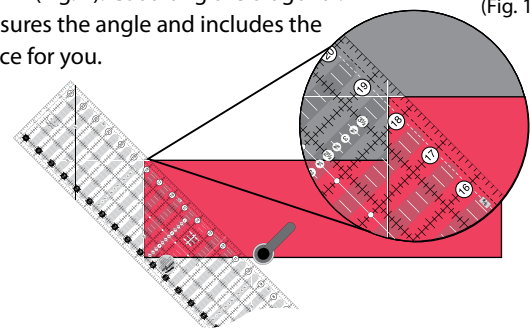

(Fig. 1)

2. For the second cut, position the ruler with the 45° angle (printed in black) on the cut, angled edge of the fabric with the 3/8" base of the ruler aligned with the bottom of the strip. Cut along the short side of the ruler as shown in (Fig. 2). This unit will be identical to the unit cut in step 1.

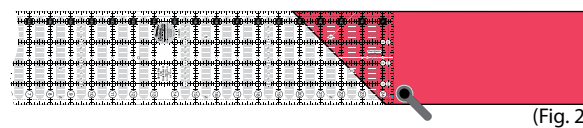

(Fig. 2)

Stitch the long edge of the triangle units to create half square triangle blocks. Feed the pointed end of the unit into your machine first to give your feed dogs something to grab on to. This ruler will cut half-square triangles with a finished size up to 4" with no waste. (See Fig 3a & Fig 3b).

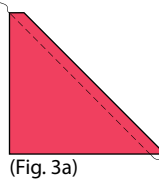

(Fig. 3a)

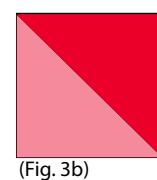

(Fig. 3b)

Cutting Flying Geese Units

1. Place a square of fabric, right sides together, on top of the rectangle - raw edges even - as shown in (Fig. 1).

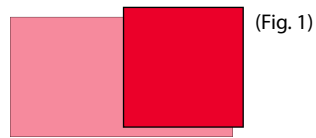

2. Position the ruler as shown. Align the horizontal 45° line with the top of the rectangle and align the vertical 45° line with the edge of the square. The black dotted line on the ruler will extend from point to point on the square. Trim along the edge of the ruler (See Fig. 2a & 2b).

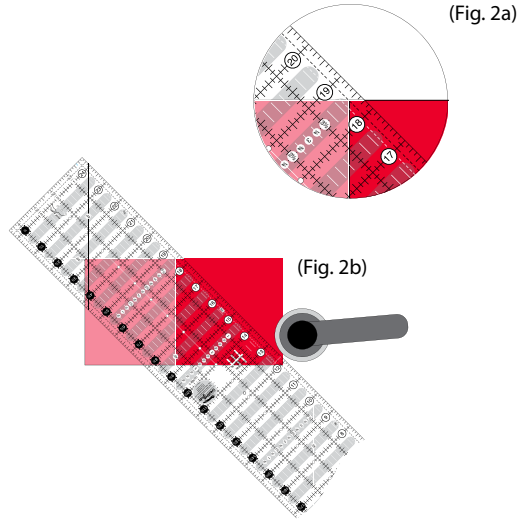

3. Stitch the cut edge using a 1/4" seam. (See Fig. 3).

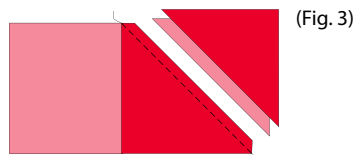

4. Press the unit open as shown in (Fig. 4).



5. Add an additional square to the opposite end. Place the ruler as shown in (Fig. 5) and trim.

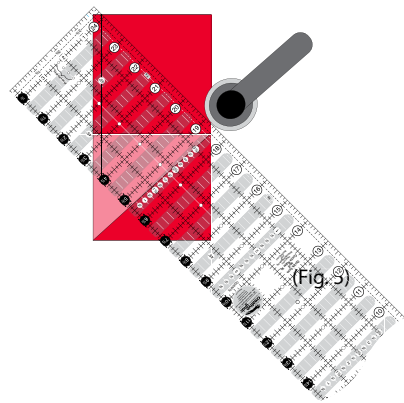

6. Stitch the cut edge using a 1/4" seam as shown in Fig. 6.

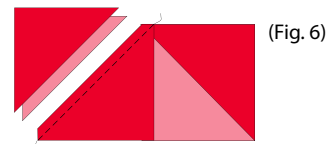

7. Press the unit open as shown in Fig. 7 to complete the flying geese unit.

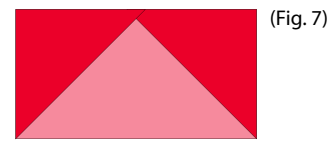

Binding and Mitered Border Seams

1. Cut your binding strips from your binding fabric. Trim the selvedge ends opposite the fold to square up the strip. Place the ruler with one of the white 45° lines along the edge of the binding strip and the top of the strip in the notch that is created where the 45° lines cross. Trim the angle.

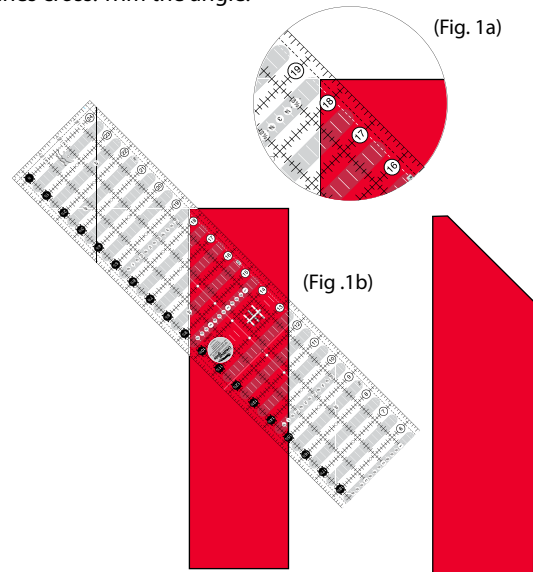

2. Place the strips right sides together, matching the angle. The dog ears have been removed for you. The pieces will fit together perfectly. Stitch using a 1/4" seam.

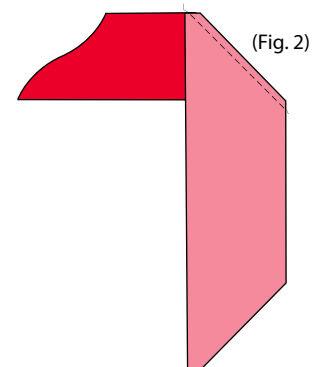

This ruler can be used to cut the basic shapes contained in these blocks and many more!

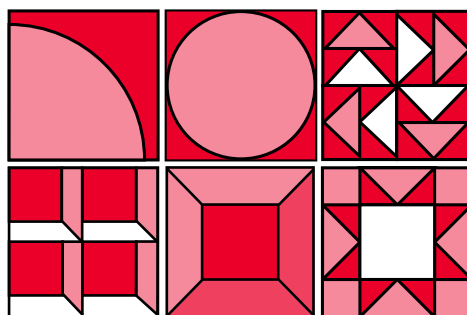

Creative Grids® USA, Inc
400 W. Dussel Dr. Ste B
Maumee, OH 43537
www.creativegridsUSA.com

Creative Grids® UK, Ltd.
Unit 23A Pate Road
Leicester Road Industrial Estate
Melton Mowbray
Leicestershire, LE13 0RG England
www.creativegrids.com