

NON-SLIP Ovals All Ways

This ruler is designed to cut quarter, half and full oval shapes in a variety of sizes.

Designed by Karla Alexander

#CGRKAOVAL

Made in USA



SEE A DEMO
SCAN WITH ANY
QR READER



Creative Grids® USA, Inc.
400 W. Dussel Dr. Ste B,
Maumee, OH 43537
www.creativegridsUSA.com

Creative Grids® UK, Ltd.
Unit 23A Pate Road
Leicester Road Industrial Estate
Melton Mowbray
Leicestershire, LE13 0RG England
www.creativegrids.com

Creative Grids is covered by U.S. Trademark Registration No. 2,796,615

CGRKAOVAL



743285 002054

NON-SLIP Ovals All Ways

The **Ovals All Ways** ruler is a cutting tool designed to cut quarter, half and full oval shapes in a variety of sizes. For use in a variety of quilt, fiber art and paper applications.

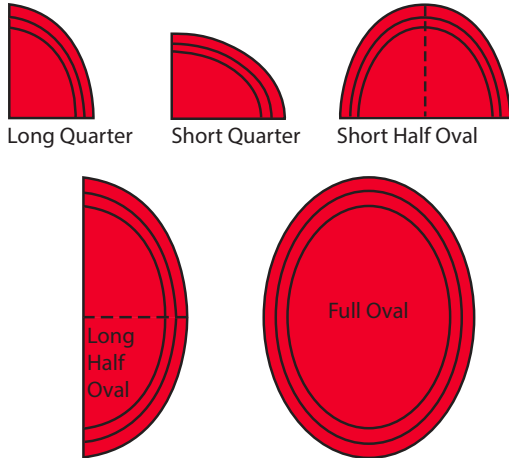

Ruler Markings

Placement Lines

There are three horizontal and vertical solid lines that each connect respectively, forming a corner in the lower left of the ruler. All three lines, labeled A, B and C are aligned with the cutting slots. Three different sized ovals can be cut from the same slot by aligning fabric with either, the A, B or C placement line.

The width and length of each shape will decrease in 1/4" increments from Placement Line A to B and from B to C. Placement line A, will yield the largest shape, B medium and C, the smallest.

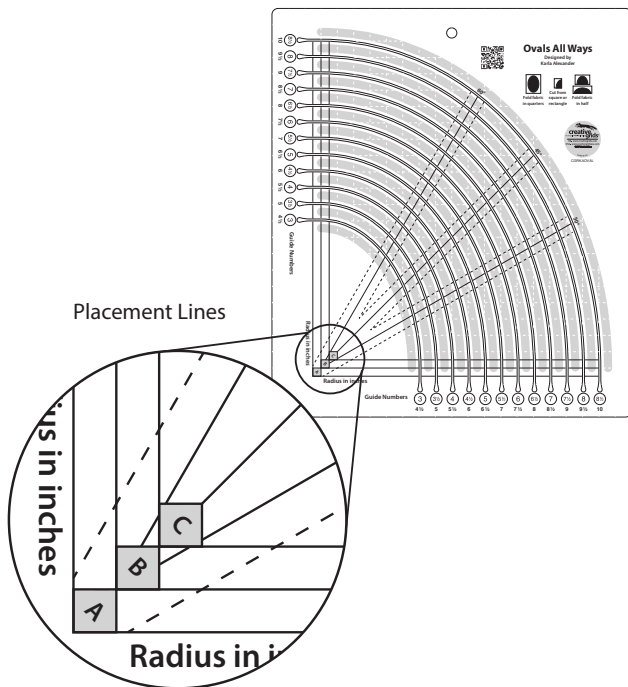

Oval Cutting Slots

There are twelve different sized slots for cutting ovals. Each slot creates an oval that measures 1-1/2" longer than it is wide. For example: a 3" wide oval will have a length of 4-1/2". The slots are accurately aligned with Placement Lines A, B and C to facilitate 3 different sized ovals for each slot, yielding a total of 36 ovals.

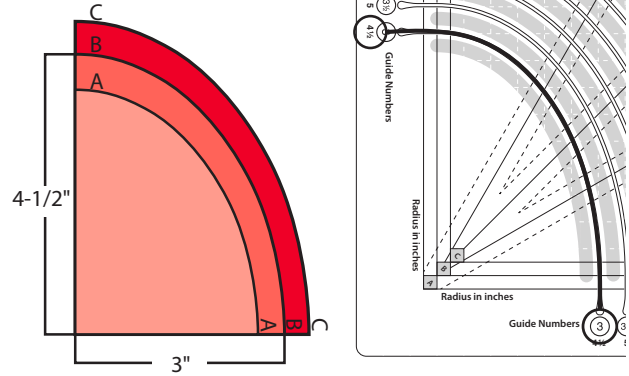

Cutting Quarter, Half and Full Ovals

For each of the twelve slots, there are two sets of numbers. The circled numbers represent the short width of the oval and are referred to as the Guide Numbers. The Guide Numbers are used as a reference measurement when referring to a specific slot. For example a quarter oval, 5" wide x 6-1/2" tall will be referred to as a 5" quarter oval.

The second row of measurements refer to the length of the oval.

You can further identify the size with the proper Placement Line. If a 5" quarter oval was cut using placement line A, B or C; refer to it as quarter oval 5" A, 5" B or 5" C.

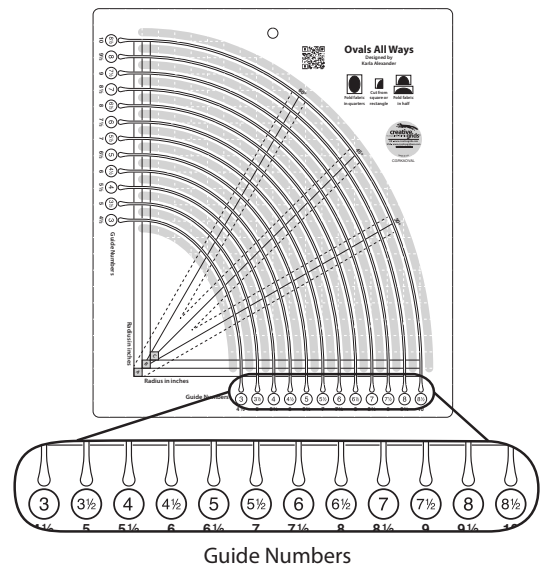

45° and 60° Markings

The 45° and 60° angles printed on the ruler provide easy alignment with pre-pieced angled patchwork. Align the angled lines with seam allowances to create a preferred design. You can also create a variety of designs by aligning the angles with fabric patterns or motifs.

45° Half Square Triangles

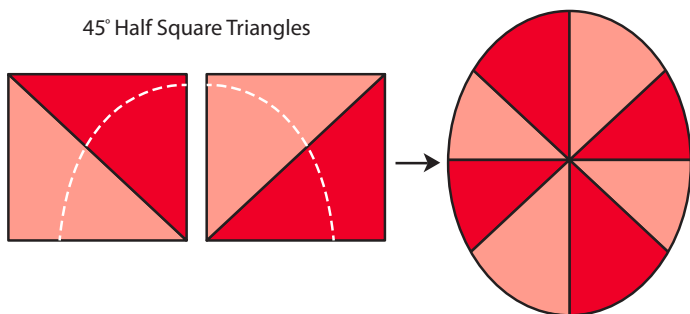

Half-Inch Grid

The white dashed half inch grid lines are extremely useful when aligning fabric for cutting and is a key tool that is necessary with an advanced technique called "Equal Exchange".

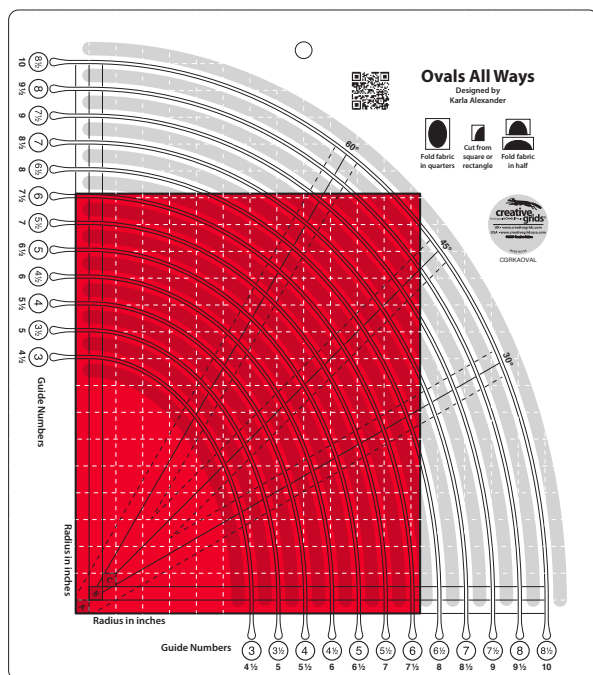

Cutting

Quarter Ovals - Placement Lines A, B and C

1. To cut a quarter oval, refer to the sizes listed in the cutting guide on the last page, and cut fabric to a minimum of that width and length.
2. Position fabric right side up with the ruler on top. Align the lower left corner of the fabric with the selected A, B or C placement line.
3. Place the blade of your rotary cutter in the selected slot and cut along the curve. Follow these same instructions when using all the placement lines A, B or C.

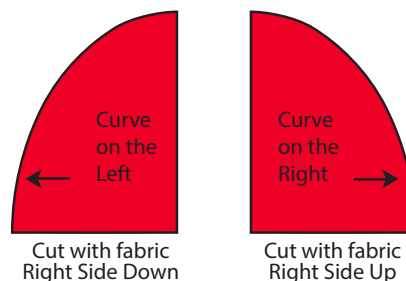

Cutting Arcs to Combine Into a Complete Oval

1. Cut four rectangles to size and pair right sides together in two sets of two each.
2. Cut each set using the desired size and placement line to yield four quarter ovals. Two with a curve on the left and two with the curve on the right side.
3. Place all pieces right side up and rotate one set 180° to create a full oval as shown.
4. Cut the background pieces in the same manner following the background rule as listed below.

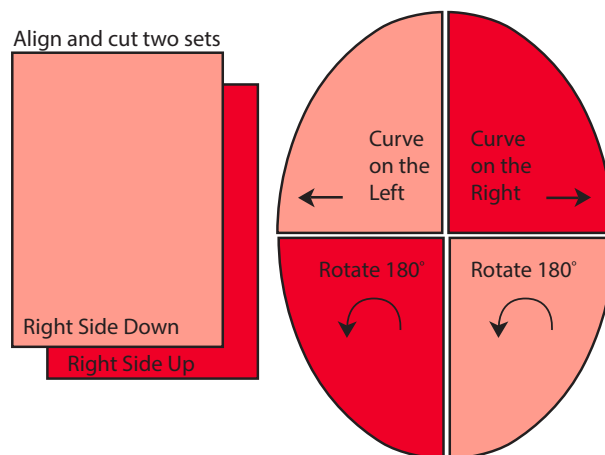

creative grids
The Original **NON-SLIP** Ruler

Creative Grids is covered by U.S. Trademark Registration No. 2,796,615

Framing (Background) Quarter Ovals

Background pieces can be cut in a variety of sizes as well as from patchwork as shown. The width of the background legs can be as wide or narrow as you like. Piecing arcs into the background will not change the width or length of the background.

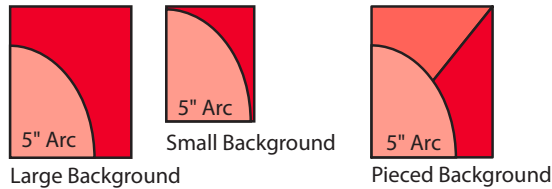

The Background Rule: Always cut the background $1/2''$ smaller than the size of the arc you are piecing in. For example, for a 5" A arc, cut a $4-1/2''$ A background. When placed side by side, the arc for the background should always be smaller. The corresponding background piece must also be cut using the same Placement Line as was used for the quarter oval.

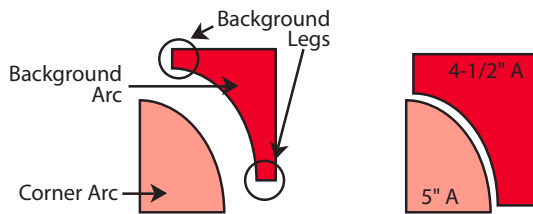

Half Ovals, A, B and C

Half ovals can be cut in two styles, short or long. Refer to the illustration below to determine which style you'd like. Refer to the sizes listed in the cutting guide, on the last page, and cut a rectangle a minimum of that width and length. Regardless of which style you choose, the following Folded Edge Rule will always apply:

The Folded Edge Rule: Fold fabric in half as shown, with right sides together and press. Always align the FOLDED EDGE with Placement Line B. Always align the RAW EDGE with Placement Line A.

Framing (Background) Half Ovals

To cut a background frame piece, follow the exact same cutting instructions used for the quarter oval, using the next smaller slot, $1/2''$ smaller than the half oval.

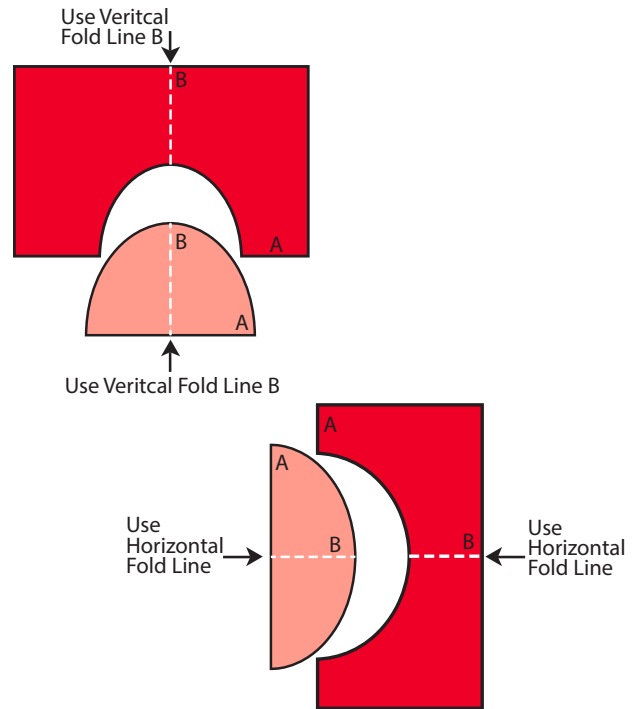
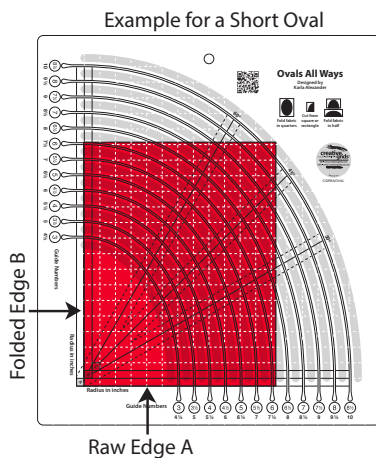

Full Ovals - Placement Lines A, B and C

Cut fabric to recommended size as directed in the cutting guide. Fold the fabric into quarters and press. Place the ruler on top of the fabric, aligning the folded corner with the selected placement line and cut along the curve.

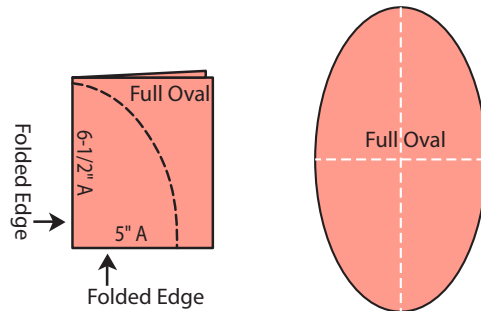

Framing (Background) Full Ovals

To cut the background piece for a full oval, follow the same cutting instructions used for a full oval, using the next smaller slot $1/2''$ LESS than the full oval.

Sewing Full Ovals

1. Make a registration mark with a tiny snip on the four half and four quarter points of the oval and its background piece as shown. **For sewing whole ovals, set the width of your seam allowance to a narrow 3/16".**
2. Align and pin the HALF WAY registration marks on the oval right sides together with the background registration marks.
3. Tack the edges together along each quarter registration mark for approximately 1/2" as shown.
4. After tacking the quarters, sew each quarter the same as directed in Sewing Quarter Ovals. When you get to the tacked seam, continue sewing over the top, and complete the oval.
5. Press seams toward the oval or as desired. Always use a towel on your ironing board when pressing curves.

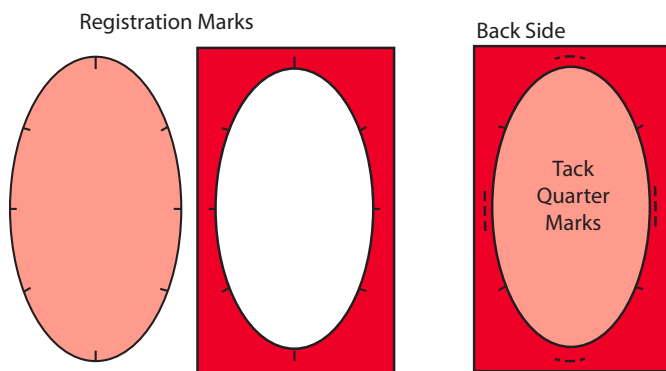

Cutting Guide

All sizes are based off the quarter oval ruler markings.
Listed measurements are the actual size needed to cut an oval.

Guide Number	Placement Lines					
	A		B		C	
3	3-1/4	4-3/4	3	4-1/2	2-3/4	4-1/4
3-1/2	3-3/4	5-1/4	3-1/2	5	3-1/4	4-3/4
4	4-1/4	5-3/4	4	5-1/2	3-3/4	5-1/4
4-1/2	4-3/4	6-1/4	4-1/2	6	4-1/4	5-3/4
5	5-1/4	6-3/4	5	6-1/2	4-3/4	6-1/4
5-1/2	5-3/4	7-1/4	5-1/2	7	5-1/4	6-3/4
6	6-1/4	7-3/4	6	7-1/2	5-3/4	7-1/4
6-1/2	6-3/4	8-1/4	6-1/2	8	6-1/4	7-3/4
7	7-1/4	8-3/4	7	8-1/2	6-3/4	8-1/4
7-1/2	7-3/4	9-1/4	7-1/2	9	7-1/4	8-3/4
8	8-1/4	9-3/4	8	9-1/2	7-3/4	9-1/4
8-1/2	8-3/4	10-1/4	8-1/2	10	8-1/4	9-3/4

Helpful Sewing Tips:

To piece curves with a minimum amount of pinning, prepare a seam allowance guide by applying a 3/4" long piece of double sticky mounting tape, on the bed of your sewing machine. Press the tape 1/4" away from the needle, extending it IN FRONT of the presser foot as shown. Gently align the fabric edges so the last 1/2" is straight as it is being fed into the sewing machine. Adjust your sewing machine to a "Needle Down" position. If your sewing

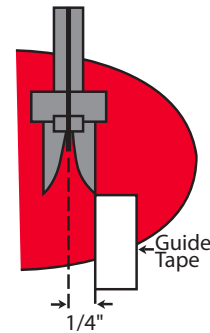

machine has an "Auto Hover" feature, I suggest temporarily turning it off while sewing curves.

Use a stiletto or the sharp point of a seam ripper to help direct the fabric as you sew.

Use a towel on your ironing board when pressing curves. This will help prevent distortion and keeps your block in place as you press.

To sew a complete oval into its corresponding background, I strongly recommend preparing a seam allowance guide by applying a 3/4" long piece of double sticky mounting tape as illustrated above. **For sewing whole ovals, set the width of your seam allowance to a narrow 3/16". See a ruler demo on www.creativegridsusa.com**



Creative Grids is covered by U.S. Trademark Registration No. 2,796,615

02.02.24

Sewing

Sewing Quarter Ovals

1. Align and pin the corner, and the registration snip marks of the quarter oval, right sides together with the background, see

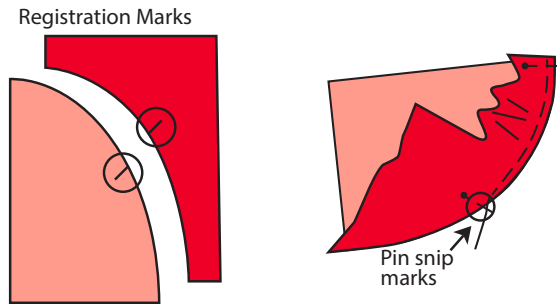
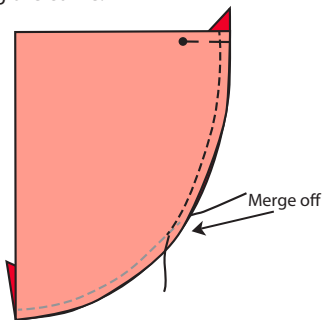

illustration.

2. Begin sewing, gently aligning the curved fabric edges together. Keep the needle in a down position and lift the presser foot up to re-adjust edges as necessary. Gently straighten the curves so the **last 1/2"** is straight, as it is being fed into the sewing machine.
3. Continue sewing all the way to the half way point and then merge off the edge of the fabric and cut the thread as shown.
4. Flip the combined unit upside down and repeat the above steps to complete sewing the curve.



Sewing Half Ovals

1. Make a registration mark with a tiny snip on the half and quarter points of the half oval and its background piece as shown.
2. Repeat the same sewing steps used above for sewing half ovals. Sewing from the corner to the half way point, then merging off. Flip unit upside down and repeat sewing steps on the opposite side.

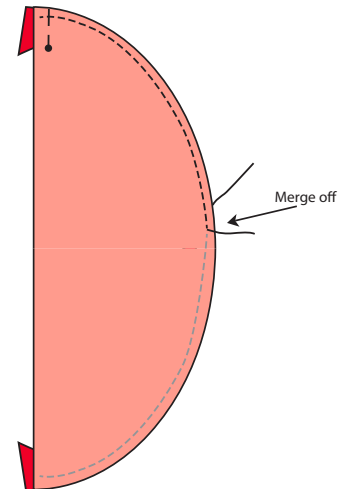
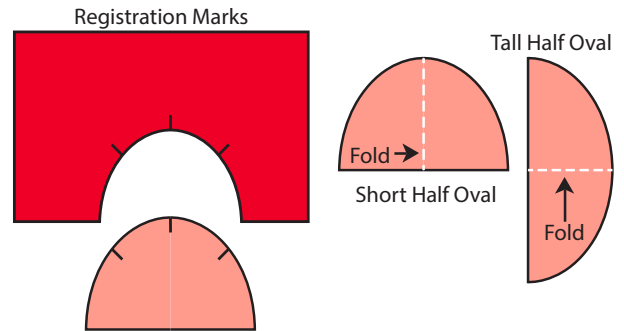

Pressing the Curves – Place your block right side down on the ironing board with seams directed toward the oval. Press, using an up and down motion to prevent distortion. Clip curves if necessary.