

# TENSE

Piergiorgio & Michele Cazzaniga  
2009-2019



XXII Compasso d'Oro  
ADI special mention



A table with a monochromatic finish.

The important technological innovation it incorporates, combined with the tensioning capacity of the components, makes it possible to build tabletops in large sizes which remain perfectly flat and also extremely light.

### Frame and tabletops

A table available in the versions:

- matt white, made of acrylic resin and rock minerals.

Tabletop, edges and legs covered with a 3mm thick sheet of resin.

- matt black and medium grey acrylic resin and FENIX high-pressure stratified laminate of the latest generation.

Tabletop in stratified laminate with mass colouration; edges and legs in acrylic resin and rock minerals.

The 35mm thick tabletop is a load-bearing composite board built with an internal frame consisting of either aluminium profiles and polystyrene filler (matt white version), or an acrylic resin honeycomb and two outer layers of aluminium (matt black or medium grey version).

35x35mm steel legs with internal structural tie.

The acrylic resin coating is in the same matt colours as the tabletop.

### Dimensions

The Tense table is an icon of the MDF Italia collection, a project which develops and evolves in terms of its own TENSITY.

Today Tense, together with Tense Material and Tense Intarsia, comes in:

- 5 heights (H35, H45, H73, H90, H110)
- 36 sizes
- 12 finishes
- over 170 types
- around 1584 variants
- 1 thickness, only 35 mm.

### Top-access

The tables are also available in the version equipped with 1 or 2 top-access and under top cable tray.

The metal cable trays are telescopic (H7/10 cm), to host various wiring systems, such multi-scket boxes, etc. wiring systems and electrical parts are not included. The steel cable spring (optional) can be inserted in the cable holes of the cable tray to lead the cables to the floor.

The top-access is made of aluminium (size 127x350 mm) in three versions:

- Single lead with soft closing (A version)
- Double lead (B version)
- OPTIONAL, single lead with soft closing, with inlay in the same finish of the table (C version).

Finishes of the top-access:

- matt white lacquer with tables in matt white
- matt black lacquer with tables in black, and medium grey.
- **price upcharge for top-access in same finish of the table for the F042502/04/31/33/36 variants.**

### Please note

Tense is recommended for indoor use, only.

The dimensional tolerance in both width and length is 0/+5mm.

**Please specify in the order if the tables would be eventually put close one another.**

Special sizes are not available

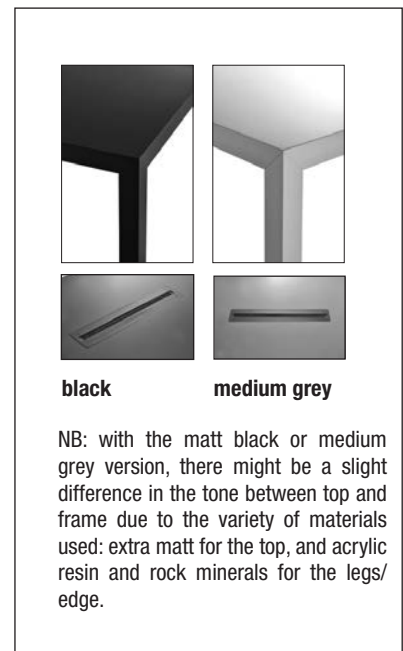

black

medium grey

NB: with the matt black or medium grey version, there might be a slight difference in the tone between top and frame due to the variety of materials used: extra matt for the top, and acrylic resin and rock minerals for the legs/ edge.

**\*NB: Colour reference of the supplier Arpa:**  
Fenix matt med. grey X021 = 0718 Grigio Londra  
Fenix matt black X022 = 0720 Nero Ingo

**For further information about specs, please refer to the technical section at the end of the price list (tables of materials/colours).**



## ABACUS

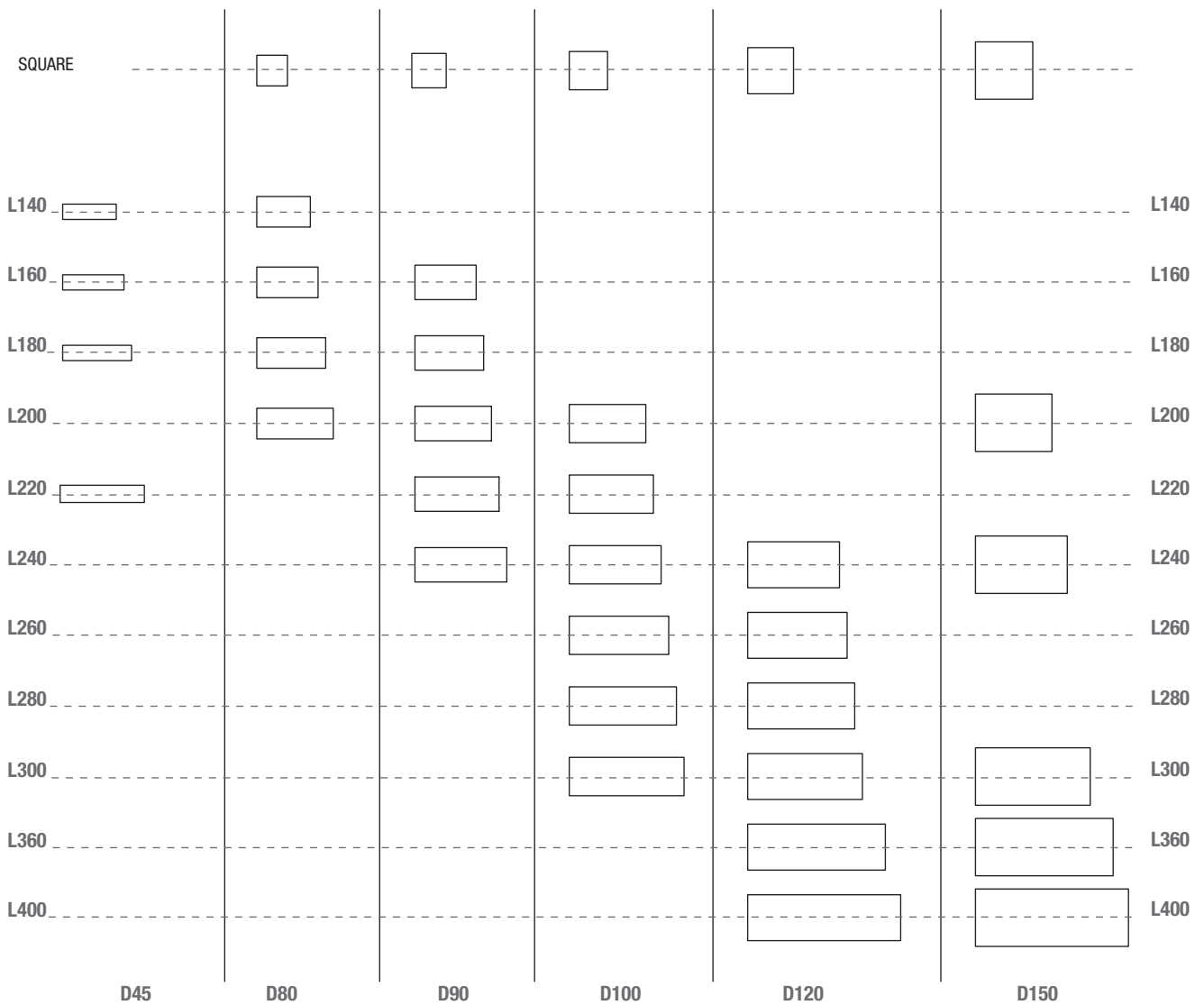
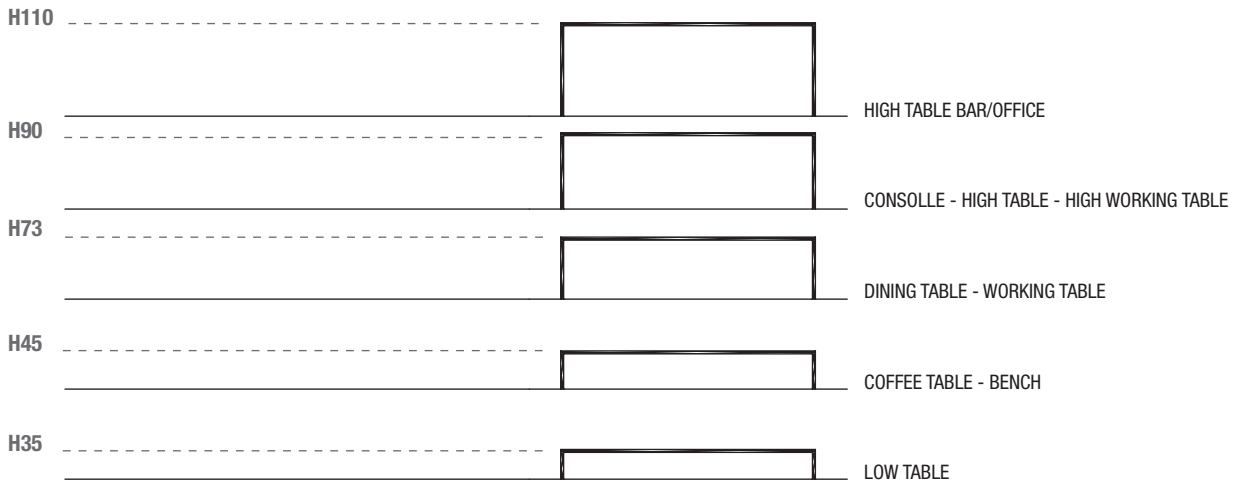

# TENSE

## TYPE OF TOP-ACCESS L35 X H12.7 CM

**A**  **Single lead (with soft closing)**

**B**  **Double lead**

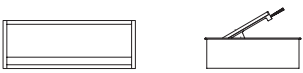
**C**  **Single lead (with soft closing), with inlay matching with the finish of the table.**  
**Price upcharge for top-access in the finish of the table for the items F042502/04/31/33/36.**

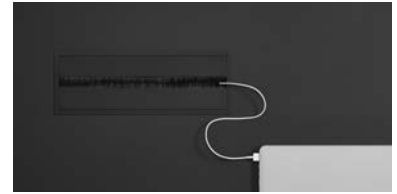

## TYPE OF METAL WIREWAY (TELESCOPIC)

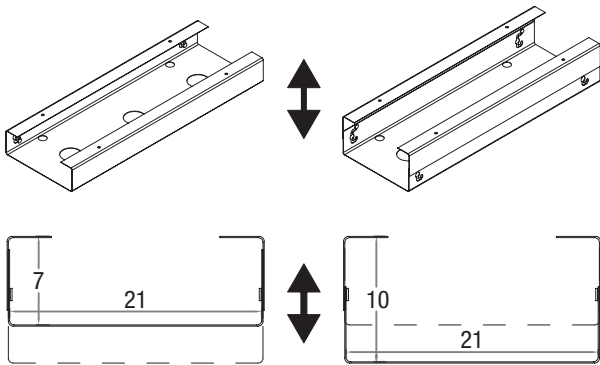

The metal cable trays are telescopic (H7/10 cm).

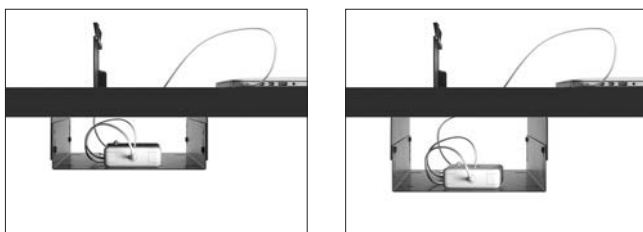

## POSITION OF THE TOP-ACCESS

### With one or two lateral top-access

X (cm)	Y (cm)
90	160
90	180
90	200
90	220
100	200
100	220

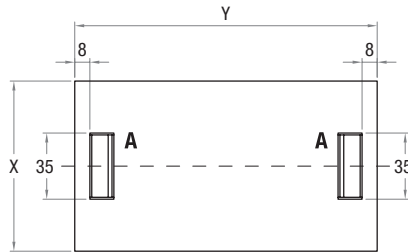

### With one central top-access

X (cm)	Y (cm)
150	150
150	200
150	240

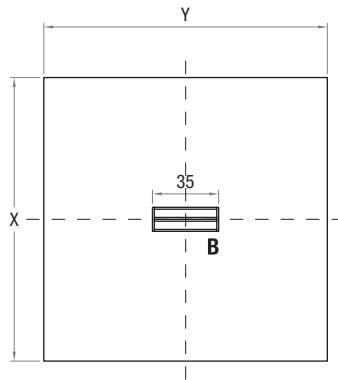

### With two front top-access

X (cm)	Y (cm)	L (cm)
90	240	52
100	240	52
100	260	64
100	280	84
100	300	104
120	240	52
120	260	64
120	280	84
120	300	104
120	360	164
120	400	116

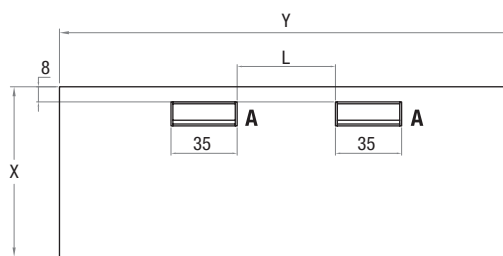

### With two central top-access

X (cm)	Y (cm)	L (cm)
120	240	52
120	260	64
120	280	84
120	300	104
120	360	164
120	400	116
150	300	104
150	360	164
150	400	116

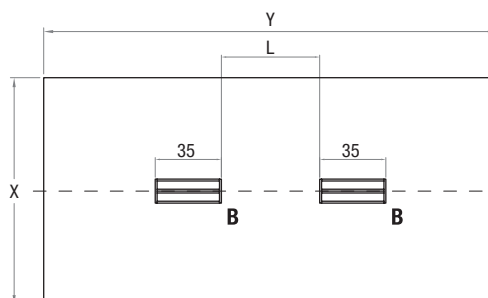

# TENSE

## EXAMPLE OF TOP-ACCESS AND METAL WIREWAY POSITION

### With one or two lateral top-access

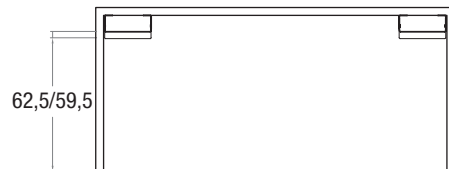
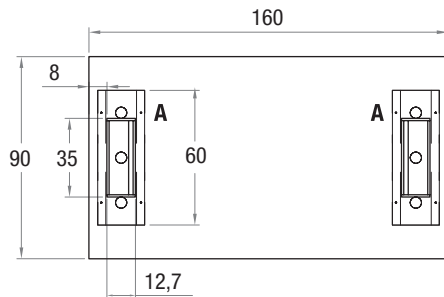

### With two front top-access

