

Alphabetical index

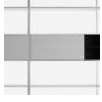

Minima 3.0 - Minima 4.2 111
by Metrica
design Bruno Fattorini



Minima 42 141
by Metrica
design Bruno Fattorini



Pentagramma new 148
by Pitsou Kedem

Minima 3.0 - Minima 4.2

3

Metrica - design Bruno Fattorini

EU - PRICE LIST 2023/24 - € - VAT EXCLUDED

2013 - 2017 - 2019 - 2023

SPECIAL PRICE

AUTUMN

AUTUMN COLLECTIONS ARE SUBJECT TO "SPECIAL PRICE". PLEASE, ALWAYS CHECK THE AVAILABILITY WITH OUR SALES DEPARTMENT. AUTUMN FINISHES FOR OPEN CONTAINERS: NATURAL WOOD X027, NATURAL GREY WOOD X028 AND NATURAL BLACK WOOD X029.

Minima 3.0. Three stands for the three key elements that compose the system: sheves, frames, cabinets. Essential and flexible, Minima 3.0 represents the natural makeover of Minima, MDF Italia collection's icon product, special mention at the XVII Compasso D'Oro ADI in 1998. Technology and innovation have enabled this thin aluminium structure that is 15 mm thick only, to propose an increasingly minimal yet strong identity. The considerable span of the shelf in extruded aluminium combined with the joining system, have allowed to develop the system in length, making it modern and adjustable to any kind of environment: home, office, community areas, contract.

Modular and flexible even thanks to the kinds of storage units. This can be with flap opening doors, drawers or open cabinet. They are simply resting inside the structure and are repositionable quite easily, thus allowing to meet any cabinets requirements as desired and to choose your own lifestyle by using different colours, woods and shapes.

Minima 3.0 is divided into 5 types:
Ground-resting, Hanging, Sketch, Sideboard, Room Divider.

Minima 3.0 is entirely made of 100% recyclable aluminum.

Finishes	Frames and shelves
F008	matt painted white X053
F051	matt painted graphite grey X054
F126	matt painted shadow grey X122
F127	matt painted pearl nickel X123

Finishes	Material shelves (Sideboard)
F194	reconstructed pietra Serena X084
F195	reconstructed stone white calce X131
F196	reconstructed stone black slate X132
*F125	Italian walnut (fine wood) X119

*material top shelf in Italian walnut not available for compositions longer than L300 cm.

Finishes	Basic cabinets (*only for open cabinet)	
F008	matt lacquered white X042	
F121	matt lacquered pearl nickel	
F122	matt lacquered shadow grey	
F050	natural black wood X029	AUTUMN
*F178	matt lacquered navy blue X165	
*F191	matt lacquered burgundy X163	
*F192	matt lacquered English green X164	
*F193	matt lacquered dune X162	
*F043	matt lacquered orange X047	
*F046	matt lacquered green X049	
*F052	matt lacquered avio blue X050	
*F053	matt lacquered mustard yellow X048	
*F054	matt lacquered dark red X046	
*F048	natural wood X027	AUTUMN
*F049	natural grey wood X028	AUTUMN
*F125	Italian walnut (fine wood) X119	



Finishes sheets



For further information about specs, please refer to the technical section at the end of the price list (tables of materials/colours).

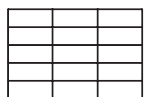

Minima 3.0 Ground-resting

Frames and shelves made of extruded aluminium and assembled together by using a concealed joining system, giving the structure stability and a special load resistance. Depth 33 cm.

Frame in aluminium, section 1.5×1.5 cm; shelf 1.5 cm thick, available in the nominal lengths (usable internal space) 30, 60, 90 and 120 cm. End frames are equipped with an extruded aluminium pressure cap.

Minima 3.0 in the ground-resting version comes in eight heights: 42.5 \ 79 \ 115.5 \ 152 \ 188.5 \ 225 \ 261.5 \ 298 cm; the first shelf is placed at 4.2 cm from the ground, and the frames are equipped with adjustable feet in aluminium with a 0/+1.5 cm adjustment.

The inner height of the compartments is always 35 cm.

Compositions with lighting

The system includes a low voltage electrified frame with integrated copper track, shelves L60/90/120 with recessed LED bar flush with outer surface. Light intensity can be adjusted with the remote control provided.

Note: the electrified system is available only for the Minima 3.0 "Floor-standing" type.

For composition specifications see the following pages.

Technical specifications

Lamp without switch fitted with oxidised extruded aluminium for recessed installation and screen in opalescent polycarbonate, width 6 mm. Neutral LED light, 4000 K, dimmable, energy class A+.

LED 24V – 11 W/m, 114/122 lm/W, CLASS 0, CRI>80, IP20 CE.

ON/OFF control system, dimmable, made up of a control unit with quick connection and IR remote control with wall support, frequency 2.4 GHz, maximum range 15 metres.

Slim power supply unit - 100 W 110/230 V, with JSD connector and client's choice of plug (IT, USA, EU, UK...).



PLEASE NOTE
ON REQUEST IT IS POSSIBLE TO ORDER MINIMA 3.0 LED WITH 3000K LIGHT. FEASIBILITY, COSTS AND DELIVERY TIMES TO BE VERIFIED WITH OUR SALES DEPARTMENT.



Minima 3.0 Hanging

Frames and shelves made of extruded aluminium and assembled together by using a concealed joining system, giving the structure stability and a special load resistance. Depth 33 cm.

Frame in aluminium, section 1.5×1.5 cm; shelf 1.5 cm thick, available in the nominal lengths (overall internal size) 60, 90 and 120 cm.

End frames are equipped with an extruded aluminium pressure cap.

Minima 3.0 in the hanging version comes in four heights: 38 / 74.5 / 111 / 147.5 cm. Inner height of compartments is always 35 cm.

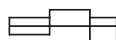

Minima 3.0 Sketch

Frames and shelves made of extruded aluminium and assembled by mean of a concealed joining system, giving the structure stability and a special load resistance.

Depth 33 cm.

Frame in aluminium, section 1.5×1.5 cm and shelf 1.5 cm.

End frames are equipped with an extruded aluminium pressure cap. Configurations:

- Composition S-1 dimensions L185 D33 H74.5
- Composition S-2 dimensions L246 D33 H74.5
- Composition S-3 dimensions L276 D33 H93
- Composition S-4 dimensions L368 D33 H110
- Composition S-5 dimensions L458 D33 H110

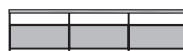

Minima 3.0 Sideboard (centre of room)

Frames and shelves made of extruded aluminium and assembled by mean of a concealed joining system, capable of giving the structure stability and a special resistance to loads.

Depth 39 cm.

Frame in aluminium, section 1.5×1.5 cm and shelf 1.5 cm.

End frames are equipped with an extruded aluminium pressure cap. Available in configurations with 5 cm thick top shelf, made in multiply wood covered in Italian walnut fine wood, reconstructed stone Serena, reconstructed stone black slate or white calce.

Minima 3.0 in the sideboard version comes in two heights, 64 cm and 100 cm, available in the following configurations:

- Composition SB-1 dimensions L184 D39 H64/H100
- Composition SB-2 dimensions L244 D39 H64/H100
- Composition SB-3 dimensions L276 D39 H64/H100
- Composition SB-4 dimensions L366 D39 H64/H100*

*material top shelf in Italian walnut not available for compositions longer than 300 cm.

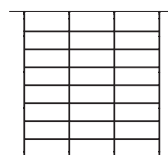

Minima 3.0 Room Divider

Frame and shelves made of extruded aluminium and assembled by mean of a concealed joining system, giving the structure stability and a special load resistance.

Depth 33 cm.

Frame in aluminium, section 1.5×1.5 cm and shelf 1.5 cm.

End frames are equipped with an extruded aluminium pressure cap.

Minima 3.0 in the Room Divider version comes in six heights: 250 / 260 / 270 / 280 / 290 / 300 cm; the first shelf is set at a variable height, depending on the composition.

The frames are equipped with a fixing pin for adjustments. Inner height of compartments is always 35 cm.



Basic Cabinets

These cabinets can be used in both the ground-resting and the hanging versions, and positioned at free choice inside the structure, they are grouped into the categories:

Open units H35 D33 L30

Made of medium density wood fibreboard, 8 mm thick, available in a matt lacquered finish in colours: white, pearl nickel, shadow grey, orange, avio blue, mustard yellow, green and dark red. Other finishes are natural wood, natural grey wood, natural black and Italian walnut fine wood.

Units with flap door H35 D33 L60 and L90

Made of medium density wood fibreboard, with variable thickness, available in a matt lacquered finish in colours: white, pearl nickel and shadow grey, or in natural black wood. Door equipped with downward compass opening, with retractable mechanism with a stainless-steel cable, shock-absorbing system, adjustable in intensity and strength in the closing and opening phases.

Two-drawer units H35 D33 L60 and L90

Made of medium density wood fibreboard, with variable thickness, available in a matt lacquered finish in colours: white, pearl nickel and shadow grey, or in natural black wood. Double drawer equipped with push-pull opening system, with totally-extractable guides.

Only for Minima 3.0 Sketch compositions:

One-drawer units H16.3 D33 L60 and L90

Made of medium density wood fibreboard, with variable thickness, available in a matt lacquered finish in colours: white, pearl nickel and shadow grey, or in natural black wood. Drawer equipped with push-pull opening system, with totally-extractable guides.

Only for Minima 3.0 Sideboard compositions:

Units with flap door H35 D39 L90 and L120 cm

Made of medium density wood fibreboard, with variable thickness, available in a matt lacquered finish in colours: white, pearl nickel and shadow grey, or in natural black wood. Door equipped with downward compass opening, with retractable mechanism with a stainless-steel cable, shock-absorbing system, adjustable in intensity and strength in the closing and opening phases.

Two-drawer units H35 D39 L90 and L120 cm

Made of medium density wood fibreboard, with variable thickness, available in a matt lacquered finish in colours: white, pearl nickel and shadow grey, or in natural black wood. Double drawer equipped with push-pull opening system, with totally-extractable guides.



LOCK FOR CABINET, UPON REQUEST

AN ADDITIONAL PRODUCTION PROCESS IS NECESSARY IN CASE OF ELEMENTS WITH LOCK, AND IT INVOLVES A PRICE UPCHARGE AND A LONGER PRODUCTION LEAD TIME THAN THE STANDARD ONES. PLEASE CHECK WITH OUR SALES DEPARTMENT. AVAILABLE LOCK TYPES:

- LOCK WITH UNIVERSAL KEY. THE SAME KEY ENABLES THE INDISTINCT OPENING OF ALL ELEMENTS WHERE THE UNIVERSAL LOCK HAS BEEN MOUNTED
- LOCK WITH CIPHERED KEY. THE CIPHERED KEY ENABLES THE OPENING ONLY OF THE ELEMENTS WHERE ITS CIPHERED LOCK HAS BEEN MOUNTED.

PLEASE NOTE

MIXED USE OF BOTH BASIC AND EXTRA CABINETS IS NOT RECOMMENDED FOR MINIMA 3.0 COMPOSITIONS.

Notes for the assembly and feasibility

General info:

- A drawing of the composition is to be sent together with your order.
- For a proper assembly, please carefully follow the instructions attached to the product.



FOR CONFIGURATIONS DIFFERENT THAN WHAT PROPOSED, AS WELL AS FOR SPECIAL COMPOSITIONS FLANKED AT DIFFERENT HEIGHTS, PLEASE ASK THE SALES DEPARTMENT TO CONFIRM FEASIBILITY (THIS MIGHT ALSO INVOLVE A PRICE UPCHARGE AND A LONGER LEAD TIME IF COMPARED WITH STANDARD PIECES).

Minima ground-resting :

- For a proper use, we suggest to install the drawers at the bottom of the unit.
- To use this system H152, H188.5, H225 (except H261.5 and H298) as a room divider for home and work environments, it is mandatory to join two structures together so as to obtain a ground depth of 66 cm to ensure a proper stability to the system. The screws for the joining are included in the installation kit.
- The wall fixing is for always suggested for heights 152 / 188.5 / 225 / 261.5 / 298 cm. The wall end frames are provided with holes for the wall fixing.
- Upon request, special heights till average 400 cm maximum can be produced, after checking with the sales department for feasibility (a price upcharge and a longer delivery time might be involved).

Sideboard

Since this piece is designed to be installed in the middle of a room, it requires dedicated cabinets for the composition.

Room Divider:

- Max. 6 columns
- Other heights available upon request: 230 / 240 / 310 / 320 cm.

Please consult the images in the following pages.

Regulations

For regulations ISO and UNI EN, please refer to the technical section at the end of the price list.

Minima 3.0 - Minima 4.2

3

EU - PRICE LIST 2023/24 - € - VAT EXCLUDED

Abacus

Basic cabinets D33 for Minima 3.0 Ground-resting, Hanging, Sketch and Room divider

Open cabinet L30



L30 D33 H35

Cabinets with flap opening door L60/90



L60 D33 H35

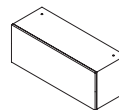

L90 D33 H35

Cabinets with two drawers L60/90



L60 D33 H35

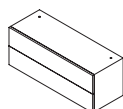

L90 D33 H35

Cabinets with one drawer L60/90 - Only for Sketch compositions



L60 D33 H16

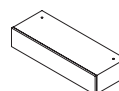

L90 D33 H16

Basic Cabinets D39 for Minima 3.0 Sideboard

Cabinets with flap opening door L90/120

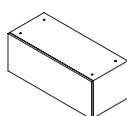

L90 D39 H35

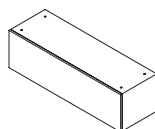

L120 D39 H35

Cabinets with two drawers L90/120

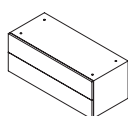

L90 D39 H35

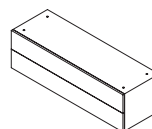

L120 D39 H35

Lock for cabinet, upon request

Flap door

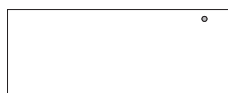

Drawers

For the cabinets with two drawers, the lock can only be put on the top drawer.

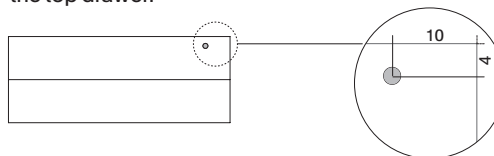

Shelves

In the price list the shelving lengths are nominal and correspond to the inner usable space of the bookcase.
Shelf D30 for Minima 3.0 ground-resting only, NOT available with LED.
Shelves for Sideboard composition have depth 39 cm



30

nominal L30
real L31.5



60

nominal L60
real L61.5



90

nominal L90
real L91.5



120

nominal L120
real L121.5

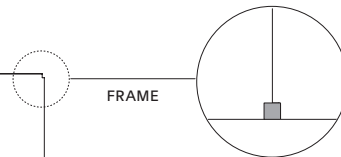

FRAME

New Extra cabinets

Cabinets with flap opening door and cabinets with two drawers in rear-lacquered glass or grooved Cimento®.
New finishes, innovative mechanism, additional size L120.



Extra Cabinets

An MDF Italia classic since its conception and the collection's modular system par excellence, Minima 3.0 now sees the addition of a new storage unit that brings this historic shelving bang up to date and in line with new architectonic and contemporary living styles.

Formality, minimalism, careful details and new finishes are the signature features confirmed and innovated in the new units added to the existing ones.

The door is further enhanced by two main materials: rear-lacquered glass and grooved Cimento®.

The development of this new unit has brought about a new partnership between MDF Italia and Cimento®.

Cimento® is a revolutionary concrete compound that, when applied to different media, gives a solidly consistent appearance to surfaces and surprising texture.

Robust tradition here teams with the minimalism of modern taste to generate unique projects. These are the fundamental elements and characteristics that have united the two companies, leading to unique collaboration.

The compound used in Cimento® products is made up of 90% mineral aggregates mixed with a cement binder to create a wide variety of finishes.



PLEASE NOTE
 MIXED USE OF BOTH BASIC AND EXTRA CABINETS IS NOT RECOMMENDED FOR MINIMA 3.0 COMPOSITIONS.

Extra storage units can be used either in the freestanding or wall-mounted version and placed inside the structure, they are divided into the following categories:

Cabinets with flap opening door H35 D33 L60/90/120 cm.

In 19 mm thick wood fibreboard faced with grey paper (similar to RAL 7012). The inside of the unit is also grey, the outside of the back panel is available in a lacquered finish in matt white, graphite grey, shadow grey, or pearl nickel, to match the shelving structure.

Door with innovative pantograph opening and closing mechanism, completely concealed inside the side panels, for extreme ease of opening.

This new mechanism gives the unit even more minimal aesthetics, reducing technical components to a minimum. Mechanism in zinc finish with Minima 3.0 in the white or pearl nickel versions, mechanism in burnished finish with Minima 3.0 in graphite grey or shadow grey.

The wooden top of the unit has been completely eliminated, meaning that only one single thickness can be seen when the unit is open.

The door comprises a frame in epoxy powder coated aluminium with a matt finish in white, graphite grey, shadow grey, or pearl nickel.

An extruded aluminium handle fitted inside the frame enables opening of the unit.

The rear of the door is a 4 mm thick wood fibreboard panel laminated in grey (similar to RAL 7012).

Door front available in two finishes:

- Rear-lacquered glass in white, graphite grey, shadow grey, or pearl nickel to match the unit structure;
- Panel in white grooved Cimento®, graphite grey, shadow grey, or pearl nickel to match the unit structure.

Cabinets with two drawers H35 D33 L60/90/120 cm.

In wood fibreboard panels of varying thicknesses (unit 19 mm thick and drawer interior 14 mm thick) faced with grey paper (similar to RAL 7012).

The inside of the unit and the insides of the drawers are also grey, the outside of the back panel is available in a lacquered finish in matt white, graphite grey, shadow grey, or pearl nickel, to match the shelving structure.

The wooden top of the unit has been completely eliminated, meaning that only one single thickness can be seen when the drawers are open.

Double drawer fitted with push-pull opening system and full-extension concealed slides.

The drawer front is a panel faced with grey with an epoxy powder coated aluminium frame in white, graphite grey, shadow grey, or pearl nickel that houses the relative finishing panels, available in:

- Rear-lacquered glass in white, graphite grey, shadow grey, or pearl nickel to match the unit structure;
- Panel in white grooved Cimento®, graphite grey, shadow grey, or pearl nickel to match the unit structure.

Side infill panels

Made from 16 mm thick wood fibreboard panels with a lacquered finish in matt white, graphite grey, shadow grey, or pearl nickel, to match the unit structure.

The infill panels hide the visible part of the mechanism and are fitted to the ends of the units, adding a finishing detail to complete the shelving composition.

Minima 3.0 - Minima 4.2

3

EU - PRICE LIST 2023/24 - € - VAT EXCLUDED

Abacus

Extra Cabinets D33 for Minima 3.0 Ground-resting, Hanging and Room divider

Cabinets with flap opening door L60/90/120 in grooved Cimento

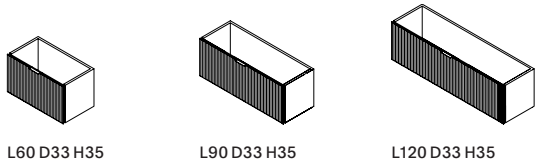

L60 D33 H35

L90 D33 H35

L120 D33 H35

Cabinets with flap opening door L60/90/120 in rear-lacquered glass

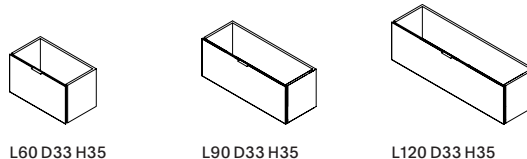

L60 D33 H35

L90 D33 H35

L120 D33 H35

Cabinets with two drawers L60/90/120 in grooved Cimento

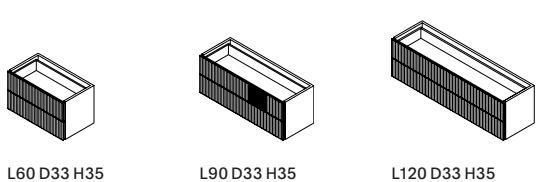

L60 D33 H35

L90 D33 H35

L120 D33 H35

Cabinets with two drawers L60/90/120 in rear-lacquered glass

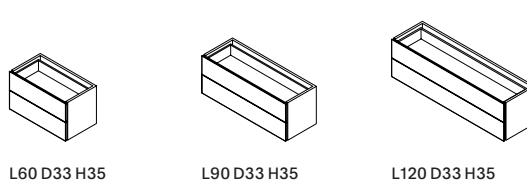

L60 D33 H35

L90 D33 H35

L120 D33 H35

Finishes

F182	white lacquered glass X011
F183	black lacquered glass X012
F184	shadow grey lacquered glass X148
F185	pearl nickel lacquered glass X149

F186	white grooved Cimento® X150
F187	graphite grey grooved Cimento® X151
F188	shadow grey grooved Cimento® X152
F189	pearl nickel grooved Cimento® X153



HINGE DETAIL FOR EXTRA CABINETS



GROOVED CIMENTO DETAIL

Minima 3.0 - Minima 4.2

3

EU - PRICE LIST 2023/24 - € - VAT EXCLUDED

Abacus

End or intermediate panel for Extra cabinets

To complete the order of the Extra cabinets, it is necessary to add the end panel (LH/RH) or intermediate panel (INT), depending on the composition. Below are some examples of use in relation to the position of the cabinets.

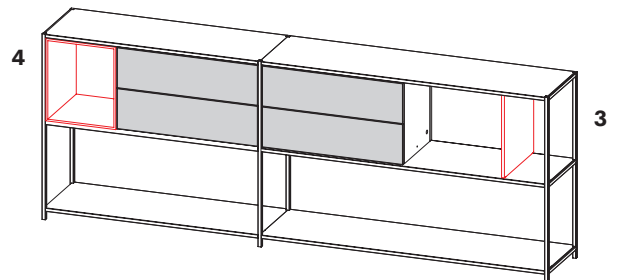
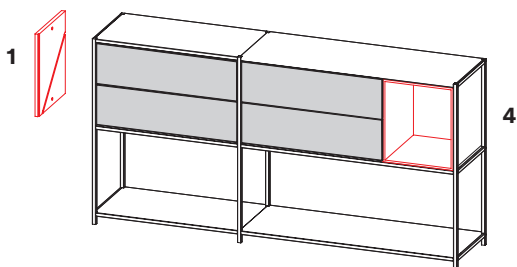
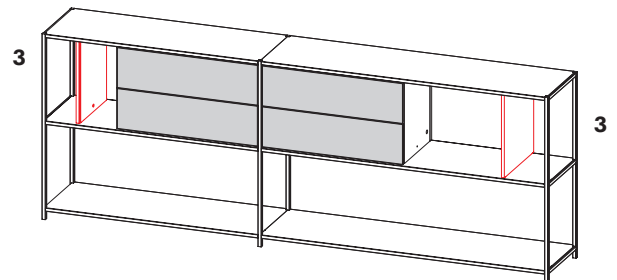
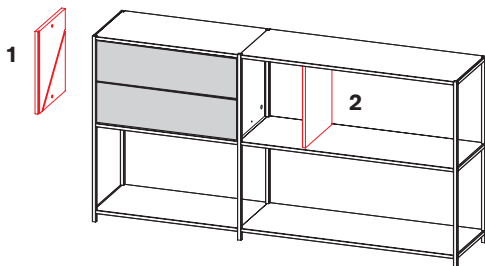
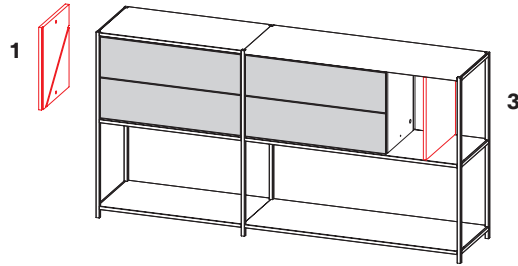
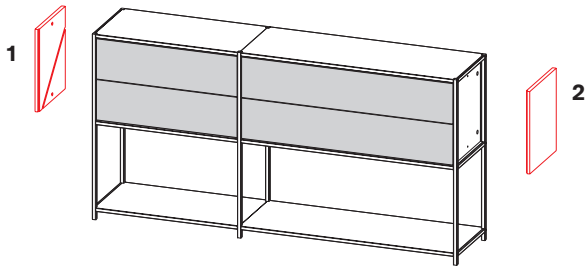

- 1 Left-hand end cap LH
- 2 Right-hand end cap RH
- 3 Intermediate cap INT
- 4 Open cabinet

Minima 3.0 ground-resting

3

EU - PRICE LIST 2023/24 - € - VAT EXCLUDED

Abacus

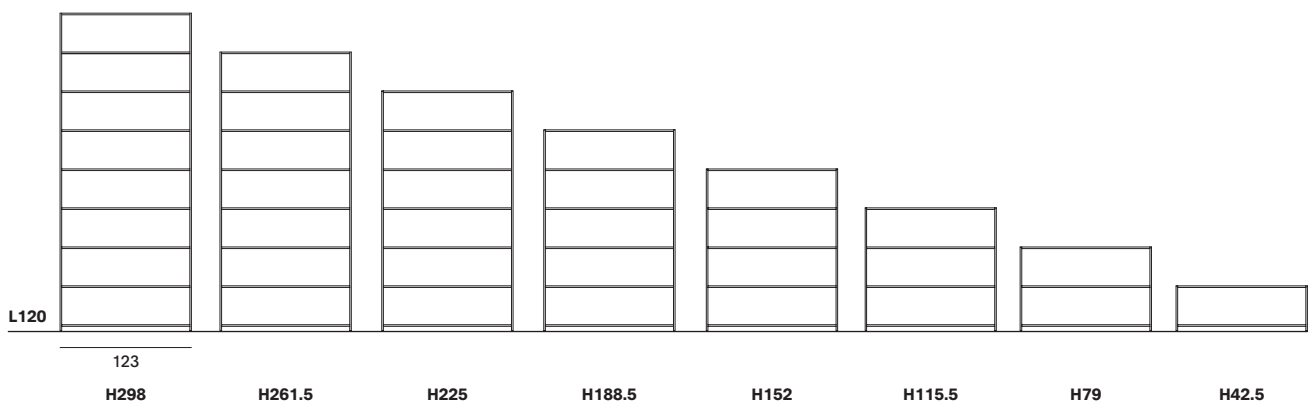
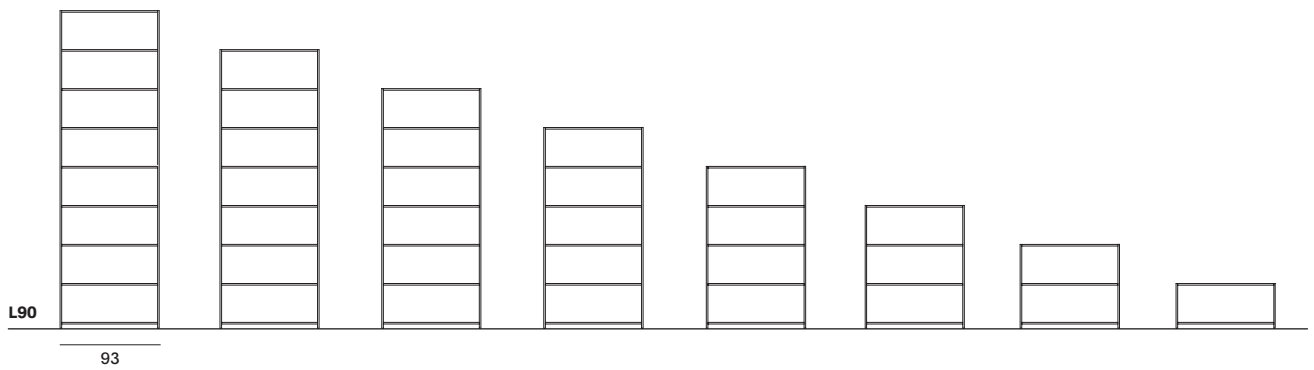
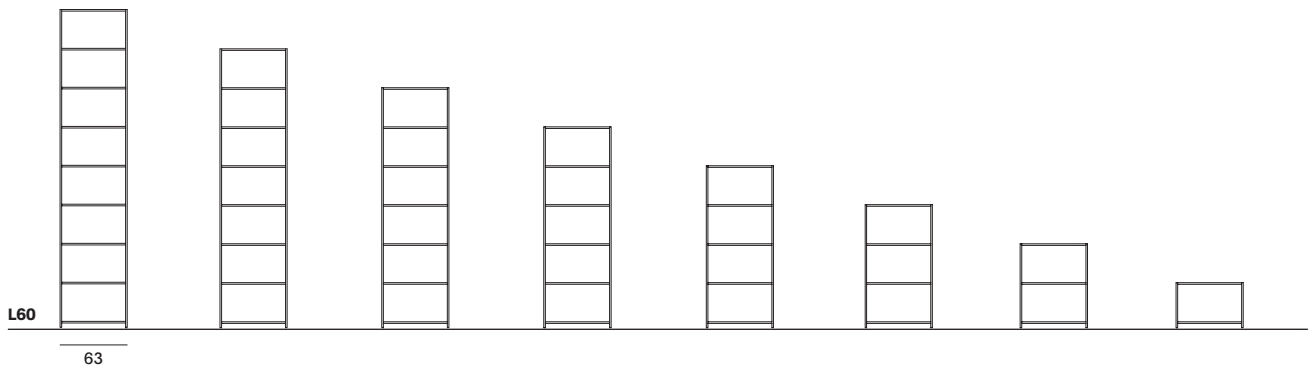
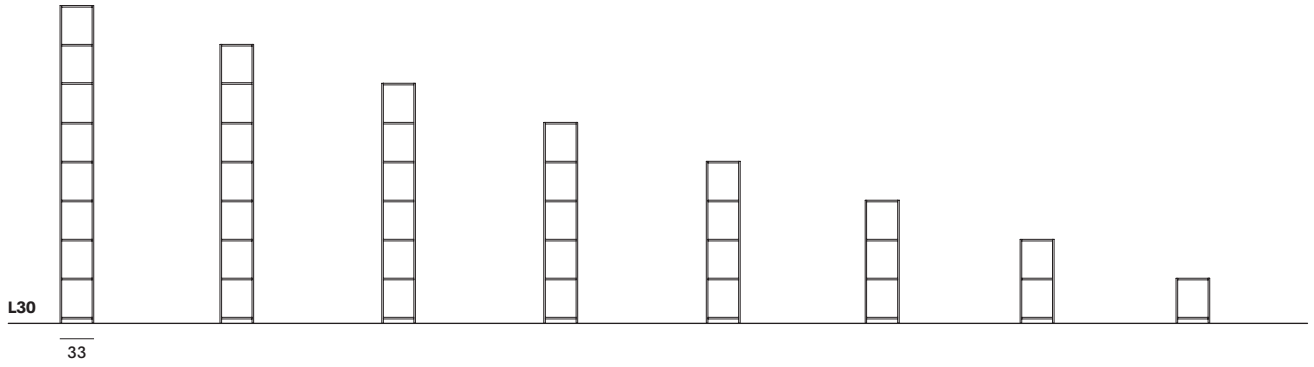

120

Minima 3.0 ground-resting

3

EU - PRICE LIST 2023/24 - € - VAT EXCLUDED

Abacus

Elements

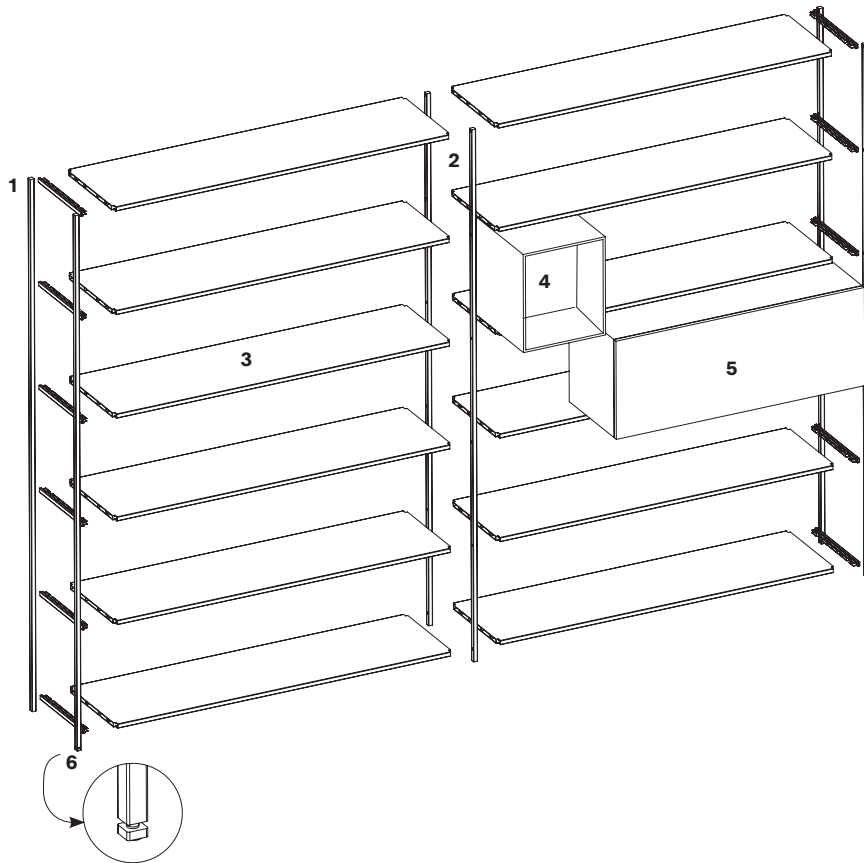

- 1 ground-resting end frame**
completed with fittings
- 2 ground-resting intermediate frame**
- 3 shelf**
- 4 open cabinet, L30**
- 5 cabinet**
- 6 adjustable feet**

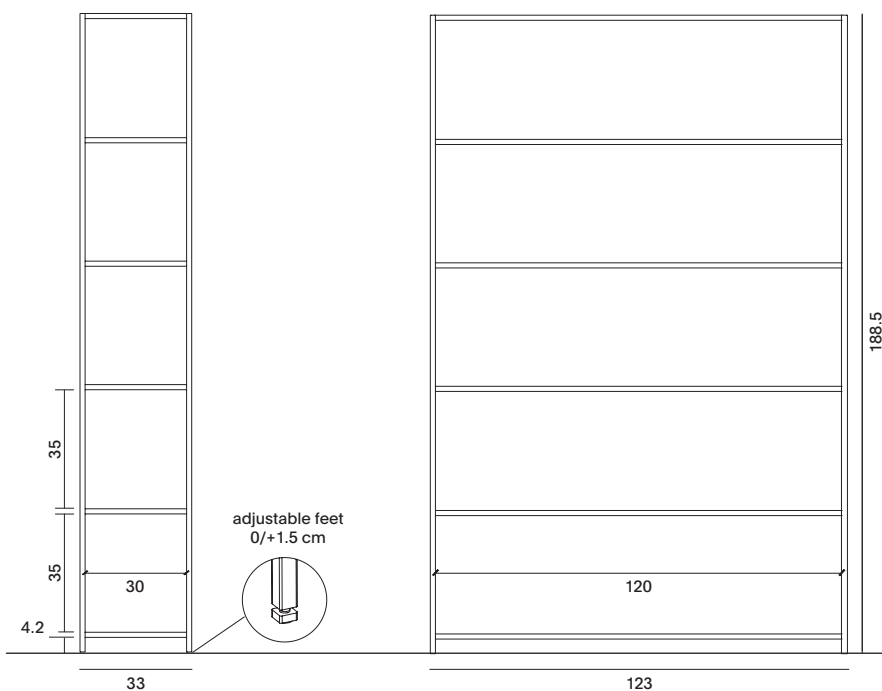

33

123

Minima 3.0 ground-resting

3

EU - PRICE LIST 2023/24 - € - VAT EXCLUDED

Abacus

A drawing of the composition with the TV position must be sent together with your order.

For ground variant only with 120 cm long shelving and in heights 115.5 cm, 152 cm, 188.5 cm, 225 cm, 261.5 cm and 298 cm the bookcase can be set up to support a TV set. With these variants, just one shelf can be removed, thus getting a 71.5×120 cm useful space, that is compatible for up to 46" TV sets (a size that may vary depending on brand and model).

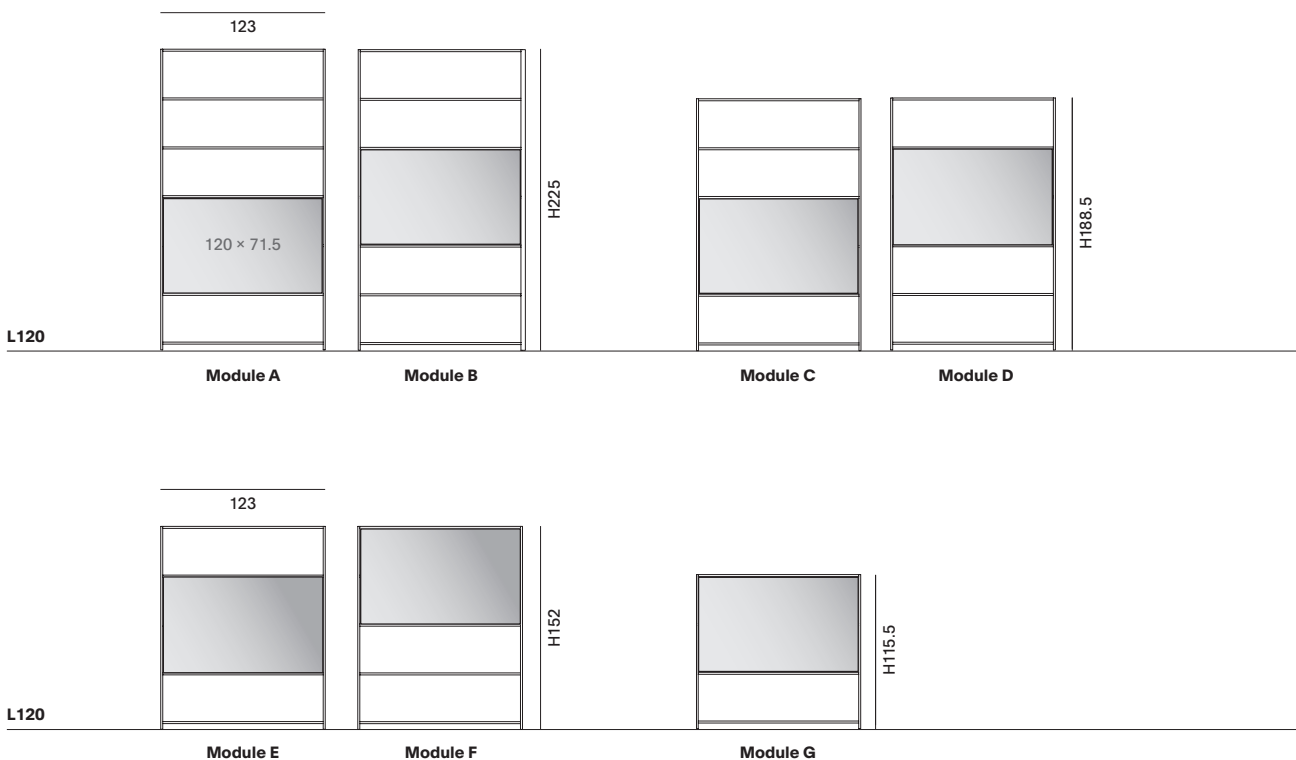

! Please note

Please be informed that it is necessary to order two caps for each shelf for a composition with TV unit placed in intermediate position.

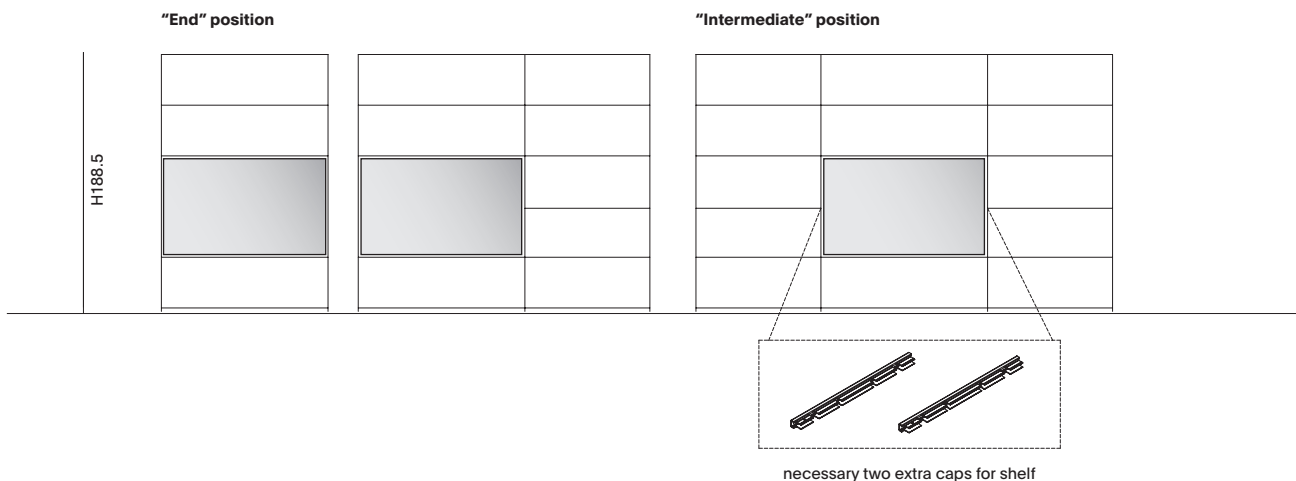

Minima 3.0 ground-resting

3

EU - PRICE LIST 2023/24 - € - VAT EXCLUDED

Abacus

Rules for compositions with integrated led

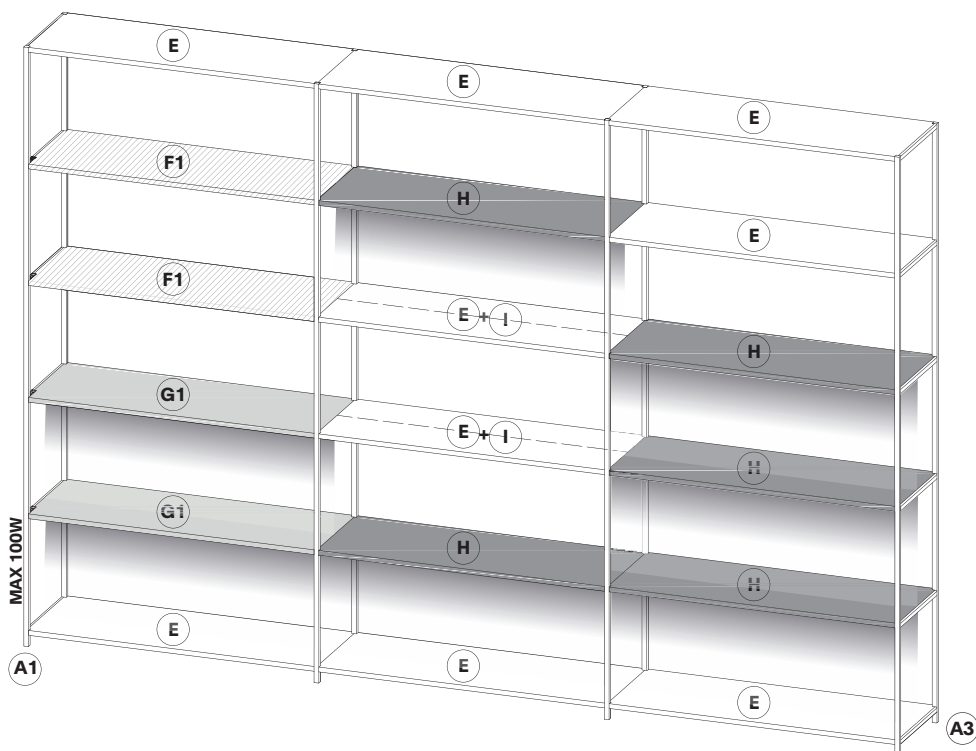

Power for led compositions

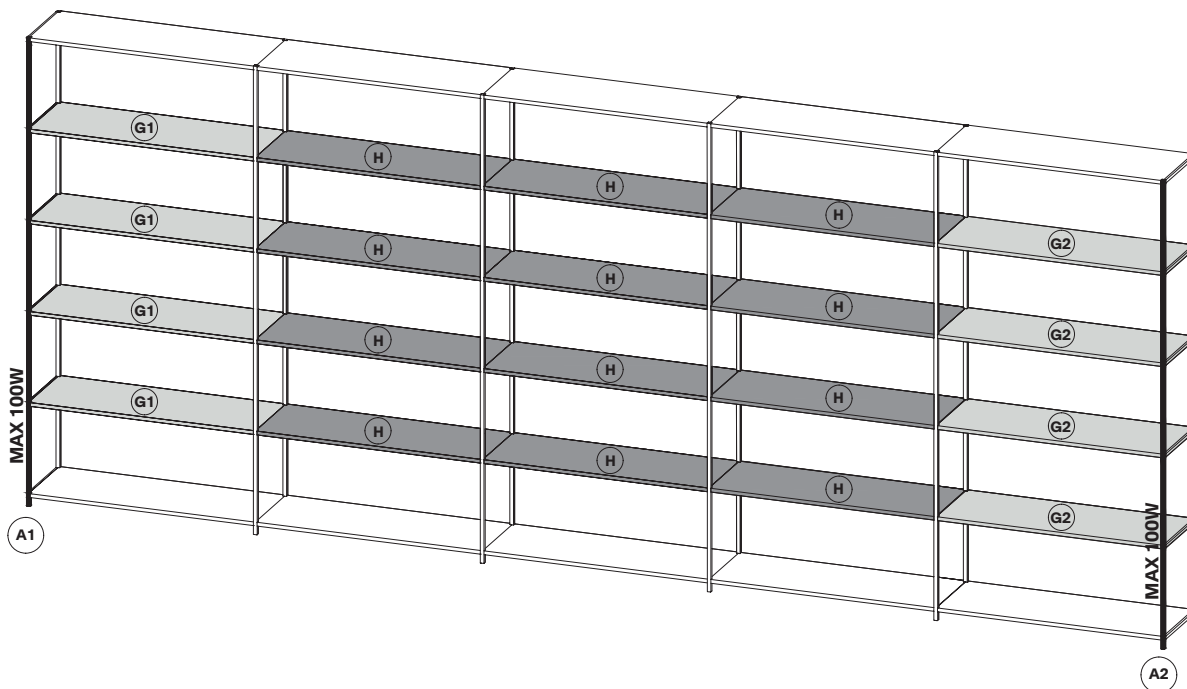

Electrified frames for all heights 100 W

In the above example:
20 shelves with led cm 90 = $20 \times 10 W = 200 W^*$

*maximum power limit for 2 electrified frames

Scheme to establish the number of electrified frames and maximum number of shelves that can be provided with led

Length of the shelf with led	Watt consumption for each shelf
60 cm	6.5 W
90 cm	10 W
120 cm	13.5 W

Abacus

Shelves



E STANDARD shelf



F1 LEFT end shelf with CONNECTOR



F2 RIGHT end shelf with CONNECTOR



G1 LEFT end shelf with CONNECTOR AND LIGHT

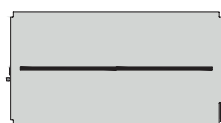

G2 RIGHT end shelf with CONNECTOR AND LIGHT



H end/intermediate shelf with LIGHT

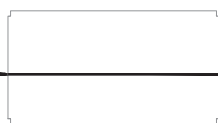

I EXTENSION KIT

Frames

A1 electrified frame left - max power 100 W

A2 electrified frame right - max power 100 W

A3 end frame, not electrified



PLEASE NOTE

- THE ELECTRIFIED FRAME IS ALWAYS IN FRONT.
- LEFT LH OR RIGHT RH ELECTRIFIED UPRIGHT TO BE SELECTED ACCORDING TO THE CUSTOMER NEEDS, OR TO THE POSITION OF THE ELECTRICAL OUTLET.
- MAX 2 ELECTRIFIED FRAMES PER COMPOSITION.
- THE SIMULTANEOUS USE OF THE LEFT LH AND RIGHT RH ELECTRIFIED UPRIGHT IS NECESSARY ONLY IF THE POWER INDICATED IN THE SCHEME (100 W PER UPRIGHT) IS EXCEEDED.
- MAX HEIGHT OF THE FRAME 298 CM.
- US/EU/UK PLUG TO BE PURCHASED ACCORDING TO THE NUMBER OF ELECTRIFIED FRAMES.

D33 shelves

E standard shelf

F1 left end shelf with connector

F2 right end shelf with connector

G1 left end shelf with connector and light

G2 right end shelf with connector and light

H end/intermediate shelf with light

I extension kit (to be inserted by the customer)

Technical specifications

Neutral LED light, 4000 K, dimmable, energy class A+.

On request it is possible to order Minima 3.0 led with 3000K light.

Feasibility, costs and delivery times to be verified with our sales department.

Electric scheme of leds

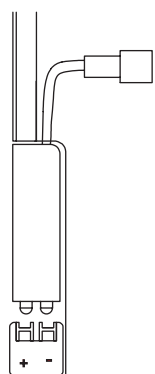

Detail of the connection of electrified frame

A1

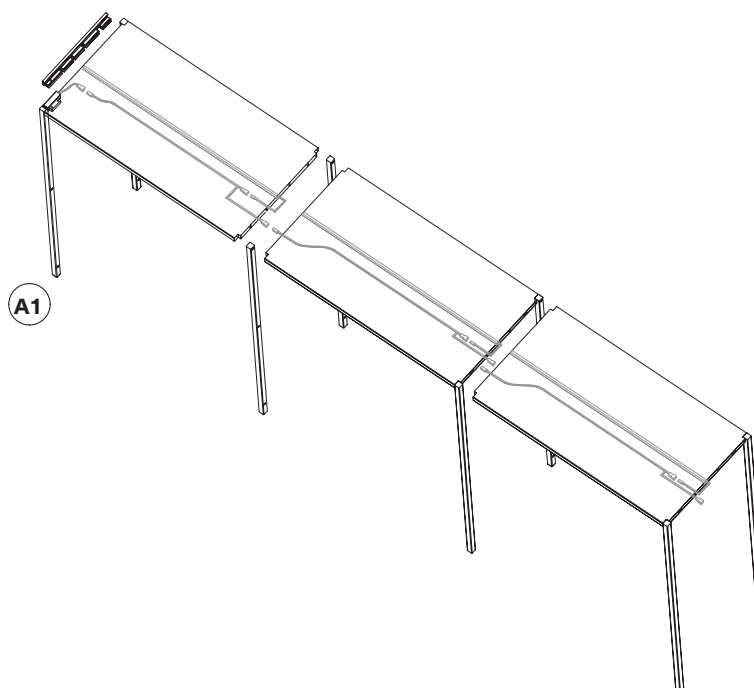

Minima 3.0 hanging

3

EU - PRICE LIST 2023/24 - € - VAT EXCLUDED

Abacus

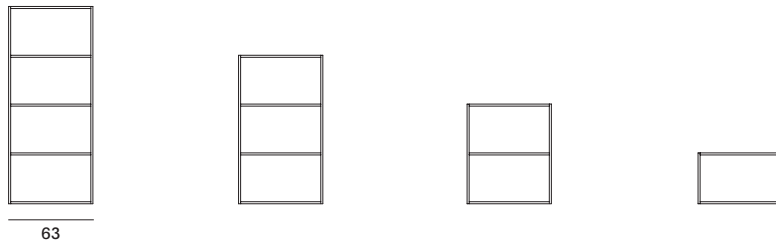

L60

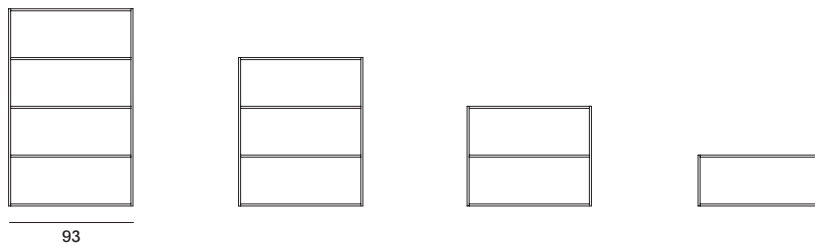

L90

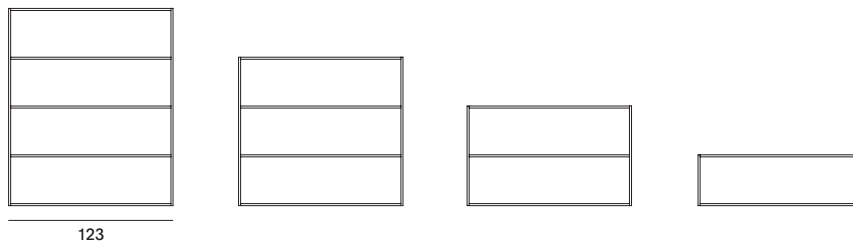

L120

H147.5

H111

H74.5

H38

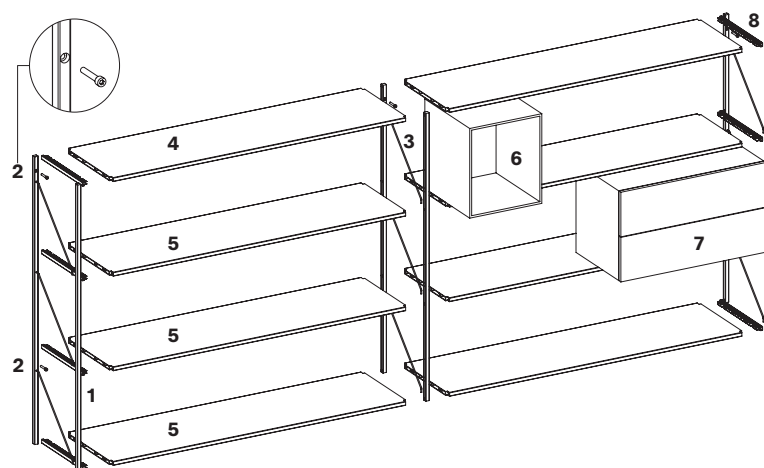



128



- 1 hanging end frame (L),**
completed with fittings and tie rods
- 2 wall-fixing**
- 3 hanging intermediate frame** with tie rods
- 4 top shelf**
- 5 shelves** (base and intermediate)
- 6 open cabinet, L30**
- 7 two-drawer cabinet**
- 8 hanging end frame (R),**
completed with fittings and tie rods

Minima 3.0 hanging

3

EU - PRICE LIST 2023/24 - € - VAT EXCLUDED

FRAMES	height	code	height	finish	side
End frame (L/R) completed with fittings 	H38 cm	113	F025003 for 2 shelves: H038 = H38 cm for 3 shelves: H074 = H74,5 cm for 4 shelves: H111 = H111 cm for 5 shelves: H147 = H147,5 cm	F008 = matt painted white X053 F051 = matt painted graphite grey X054 F126 = matt painted shadow grey X122 F127 = matt painted pearl nickel X123	L001 = R L002 = L
	H74,5 cm	177			
	H111 cm	240			
	H147,5 cm	302			
Intermediate frame 	H38 cm	65	F025004 for 2 shelves: H038 = H38 cm for 3 shelves: H074 = H74,5 cm for 4 shelves: H111 = H111 cm for 5 shelves: H147 = H147,5 cm	F008 = matt painted white X053 F051 = matt painted graphite grey X054 F126 = matt painted shadow grey X122 F127 = matt painted pearl nickel X123	
	H74,5 cm	105			
	H111 cm	142			
	H147,5 cm	183			
code composition		F_ _ _ _ _	H_ _ _	F_ _ _	L_ _ _
		code	height	finish	side

SHELVES D33	length	code	length	finish
top shelf D33 for hanging system 	L60 cm	147	F025005 W060 = L60 cm W090 = L90 cm W120 = L120 cm	F008 = matt painted white X053 F051 = matt painted graphite grey X054 F126 = matt painted shadow grey X122 F127 = matt painted pearl nickel X123
	L90 cm	176		
	L120 cm	216		
shelf D33 for hanging system 	L60 cm	153	F025011 W060 = L60 cm W090 = L90 cm W120 = L120 cm	F008 = matt painted white X053 F051 = matt painted graphite grey X054 F126 = matt painted shadow grey X122 F127 = matt painted pearl nickel X123
	L90 cm	183		
	L120 cm	219		
code composition		F_ _ _ _	W_ _ _	F_ _ _
		code	length	finish

for cabinets choice see page 118

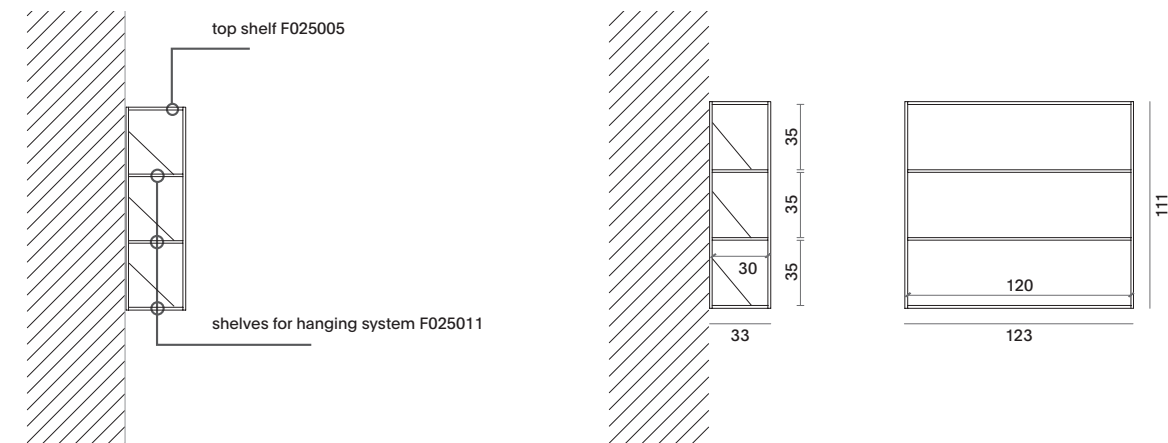

Minima 3.0 sketch

3

EU - PRICE LIST 2023/24 - € - VAT EXCLUDED

Abacus

composition S-1 L185 D33 H74.5

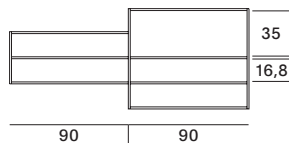

composition S-2 L246 D33 H74.5

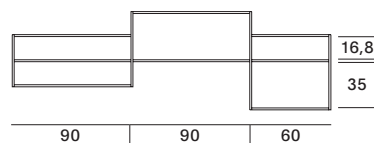

composition S-3 L276 D33 H93

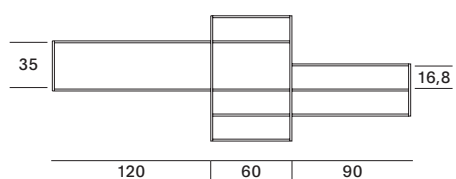

composition S-4 L368 D33 H110

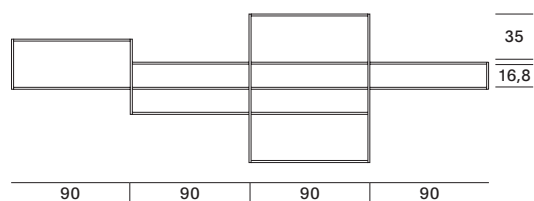

composition S-5 L458 D33 H110

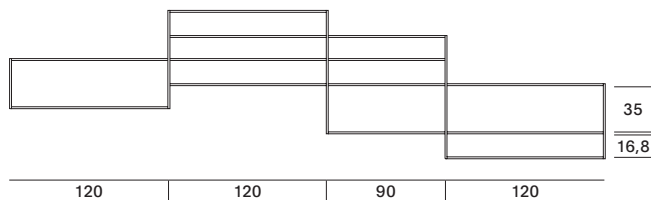

Minima 3.0 sideboard

3

EU - PRICE LIST 2023/24 - € - VAT EXCLUDED

Abacus

composition SB-1 L184 D39 H64
2 cabinets L90 to be added (mandatory)

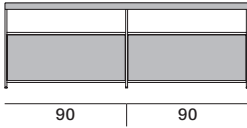

composition SB-1 L184 D39 H100
4 cabinets L90 to be added (mandatory)

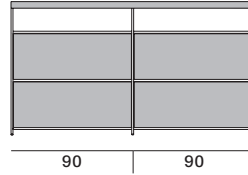

composition SB-2 L244 D39 H64
2 cabinets L120 to be added (mandatory)

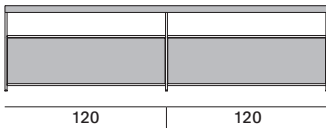

composition SB-2 L244 D39 H100
4 cabinets L120 to be added (mandatory)

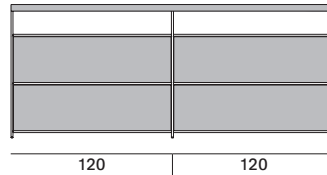

composition SB-3 L276 D39 H64
3 cabinets L90 to be added (mandatory)

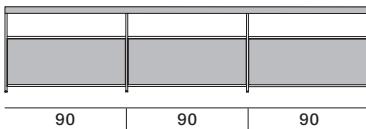

composition SB-3 L276 D39 H100
6 cabinets L90 to be added (mandatory)

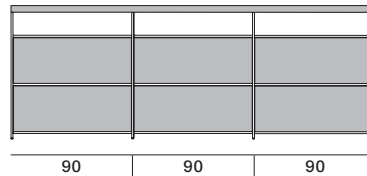

composition SB-4 L366 D39 H64
3 cabinets L120 to be added (mandatory)

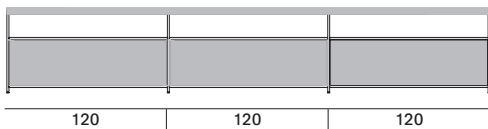

composition SB-4 L366 D39 H100
6 cabinets L120 to be added (mandatory)

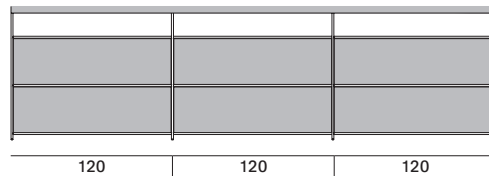

PLEASE NOTE
CABINETS MANDATORY TO BE ADDED
CABINETS D39 FOR MINIMA 3.0 SIDEBOARD ARE WITH FLAP OPENING
DOOR OR DRAWERS L90/120.

Minima 3.0 room divider

3

EU - PRICE LIST 2023/24 - € - VAT EXCLUDED

Abacus

Example of configuration with 7 shelves

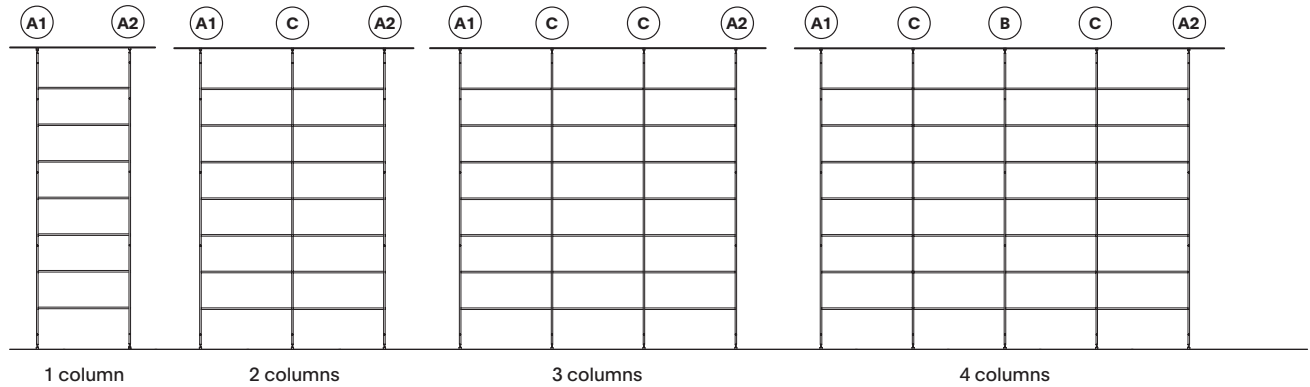

Width of the compositions and pairing of the shelves.

Please note: compositions max 6 columns. Mixed compositions, eg: 60 + 90 + 60, are not allowed

60	120 (60+60)	180 (60+60+60)	240 (60+60+60+60)
90	180 (90+90)	270 (90+90+90)	360 (90+90+90+90)
120	240 (120+120)	360 (120+120+120)	480 (120+120+120+120)

List of components of the end frame

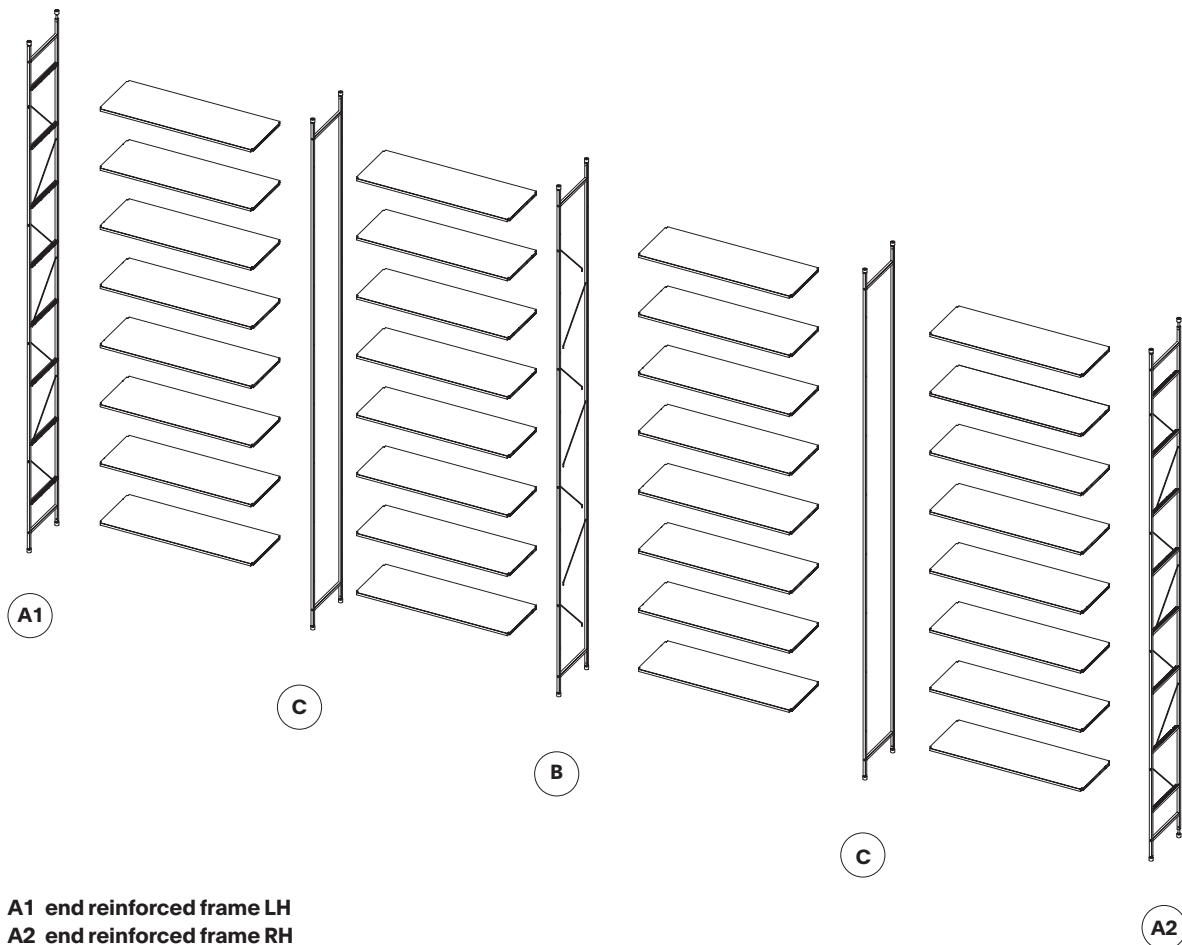

- A1 end reinforced frame LH
- A2 end reinforced frame RH
- B intermediate reinforced frame
- C intermediate frame

Minima 3.0 room divider

3

EU - PRICE LIST 2023/24 - € - VAT EXCLUDED

Abacus

Example of configuration with 7 shelves

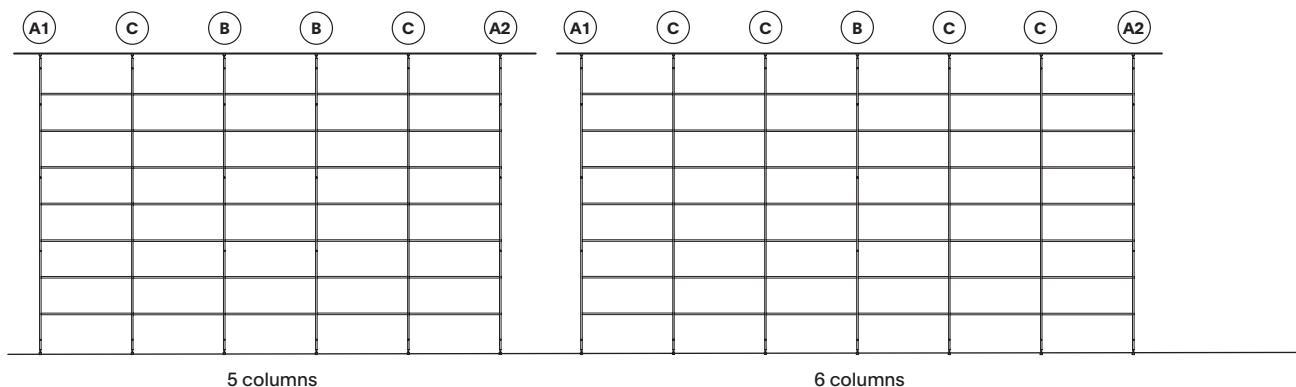

Width of the compositions and pairing of the shelves.
Important: compositions max 6 columns. Mixed compositions, eg: 60 + 90 + 60, are not allowed

300 (60+60+60+60+60)	360 (60+60+60+60+60+60)
450 (90+90+90+90+90)	540 (90+90+90+90+90+90)
600 (120+120+120+120+120)	720 (120+120+120+120+120+120)

Compositions prices

No. columns	height	A1	A2	B	C	hanging shelf	end shelf L	end shelf R
		reinforced end frame L F025071	reinforced end frame R F025072	reinforced intermediate frame F025073	intermediate frame F025074	D33 F025005	D33 F025011	D33 F025079
1 column	H250	1	1	-	-	1	5	-
	H260	1	1	-	-	1	5	-
	H270	1	1	-	-	1	6	-
	H280	1	1	-	-	1	6	-
	H290	1	1	-	-	1	6	-
	H300	1	1	-	-	1	6	-
2 columns	H250	1	1	-	1	2	-	5
	H260	1	1	-	1	2	-	5
	H270	1	1	-	1	2	-	6
	H280	1	1	-	1	2	-	6
	H290	1	1	-	1	2	-	6
	H300	1	1	-	1	2	-	6
3 columns	H250	1	1	-	2	8	-	5
	H260	1	1	-	2	8	-	5
	H270	1	1	-	2	9	-	6
	H280	1	1	-	2	9	-	6
	H290	1	1	-	2	9	-	6
	H300	1	1	-	2	9	-	6
4 columns	H250	1	1	1	2	4	-	10
	H260	1	1	1	2	4	-	10
	H270	1	1	1	2	4	-	12
	H280	1	1	1	2	4	-	12
	H290	1	1	1	2	4	-	12
	H300	1	1	1	2	4	-	12
5 columns	H250	1	1	2	2	5	5	10
	H260	1	1	2	2	5	5	10
	H270	1	1	2	2	5	6	12
	H280	1	1	2	2	5	6	12
	H290	1	1	2	2	5	6	12
	H300	1	1	2	2	5	6	12
6 columns	H250	1	1	1	4	16	-	10
	H260	1	1	1	4	16	-	10
	H270	1	1	1	4	18	-	12
	H280	1	1	1	4	18	-	12
	H290	1	1	1	4	18	-	12
	H300	1	1	1	4	18	-	12

Minima 3.0 room divider

3

EU - PRICE LIST 2023/24 - € - VAT EXCLUDED

Abacus

Heights

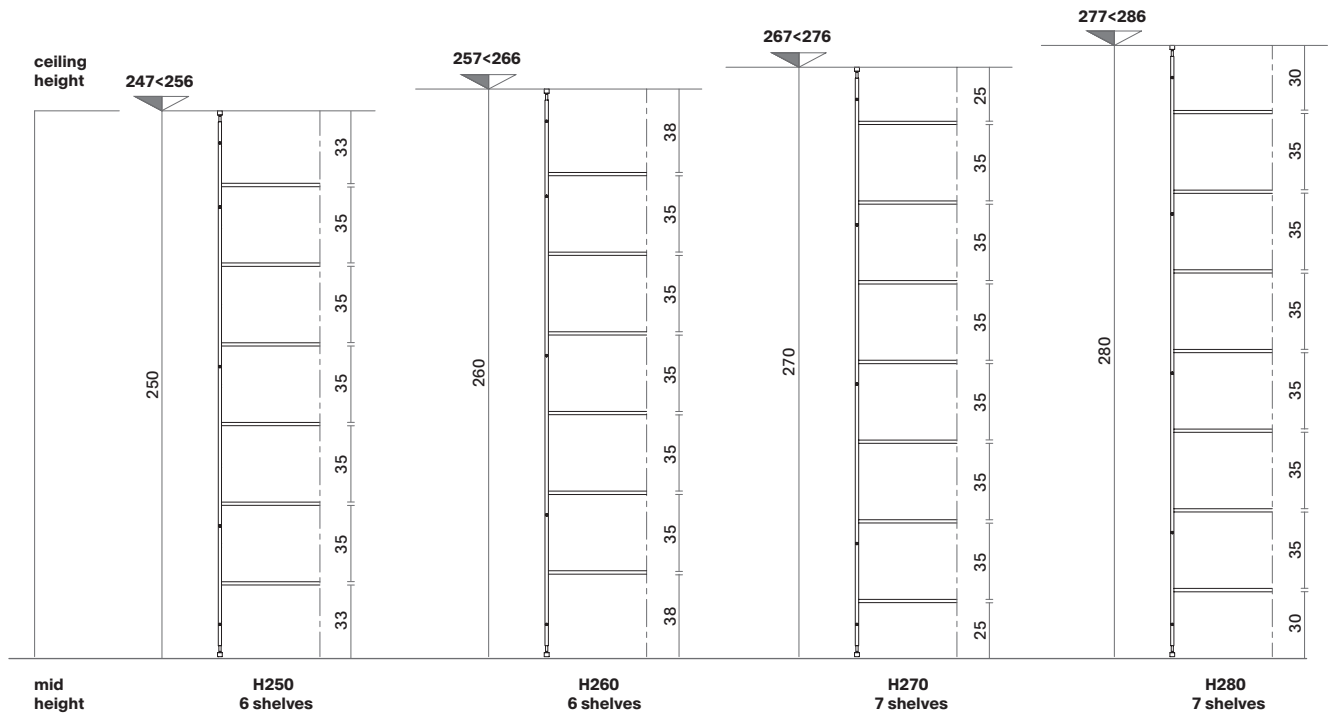

Heights on request

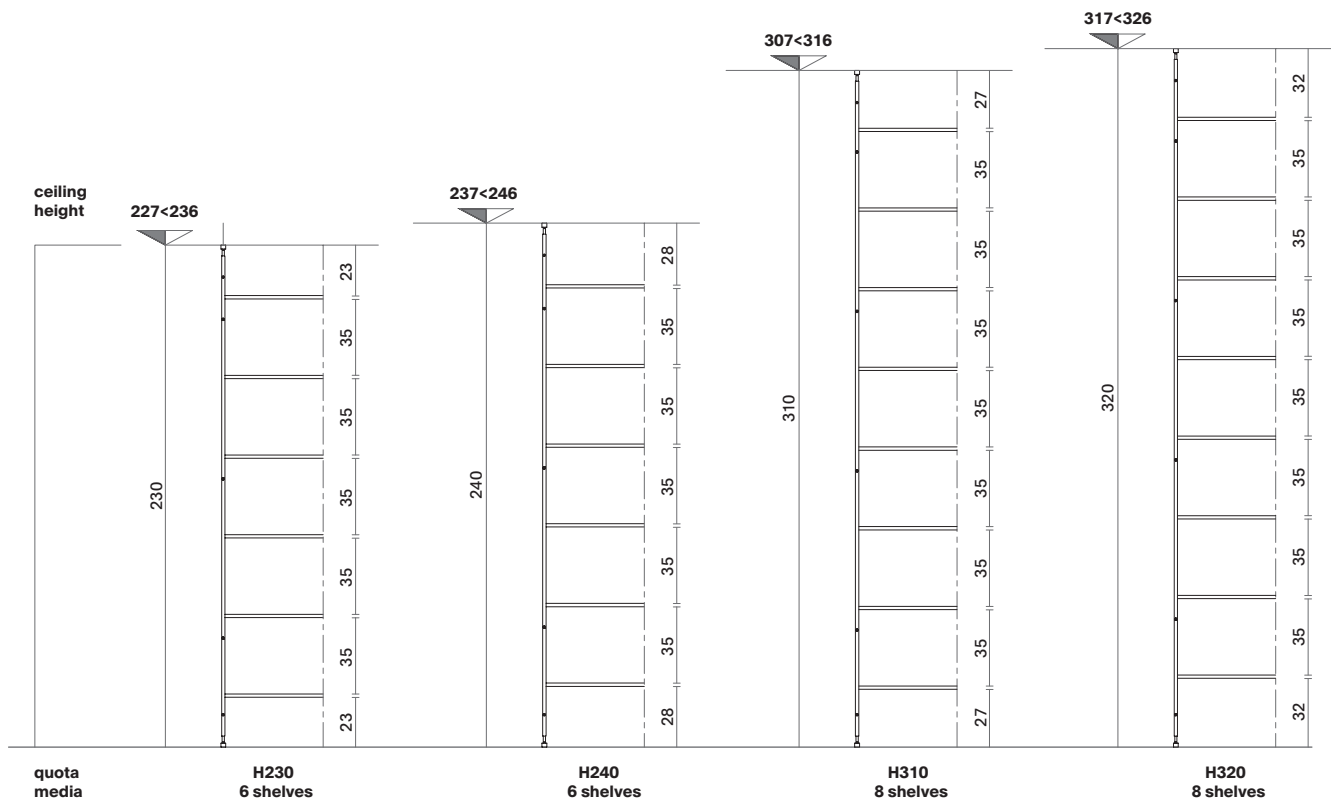

Minima 3.0 room divider

3

EU - PRICE LIST 2023/24 - € - VAT EXCLUDED

Abacus

Heights

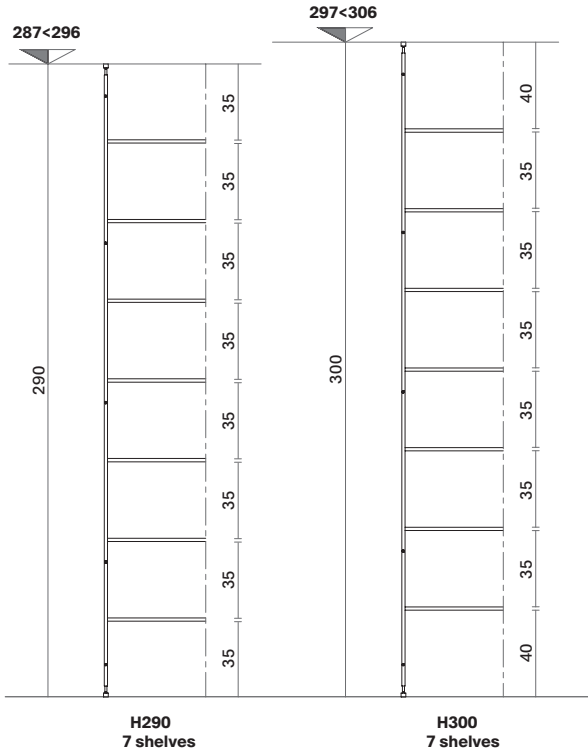

Minimum adjustment

Maximum adjustment

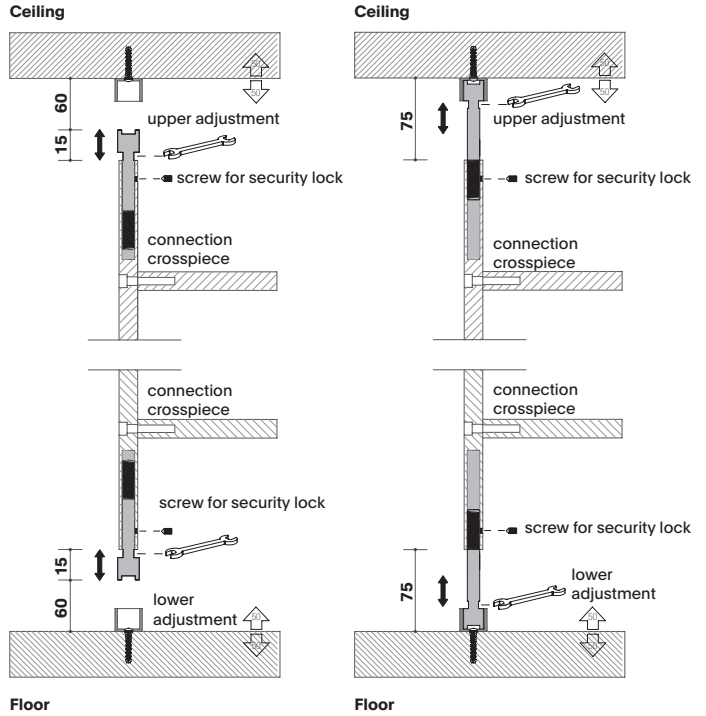

Elements needed for custom heights

Feasibility, prices and delivery times are to be verified with our sales department.

No. columns	height	A1 reinforced end frame L F025071	A2 reinforced end frame R F025072	B reinforced intermediate frame F025073	C intermediate frame F025074	shelf D33 F025005	hanging shelf D33 F025011	end shelf L D33 F025079	end shelf R D33 F025081
		1 column	H230	1	1	-	-	1	5
	H240	1	1	-	-	1	5	-	-
	H310	1	1	-	-	1	7	-	-
	H320	1	1	-	-	1	7	-	-
2 columns	H230	1	1	-	1	2	-	5	5
	H240	1	1	-	1	2	-	5	5
	H310	1	1	-	1	2	-	7	7
	H320	1	1	-	1	2	-	7	7
3 columns	H230	1	1	-	2	8	-	5	5
	H240	1	1	-	2	8	-	5	5
	H310	1	1	-	2	10	-	7	7
	H320	1	1	-	2	10	-	7	7
4 columns	H230	1	1	1	2	4	-	10	10
	H240	1	1	1	2	4	-	10	10
	H310	1	1	1	2	4	-	14	14
	H320	1	1	1	2	4	-	14	14
5 columns	H230	1	1	2	2	5	5	10	10
	H240	1	1	2	2	5	5	10	10
	H310	1	1	2	2	5	7	14	14
	H320	1	1	2	2	5	7	14	14
6 columns	H230	1	1	1	4	16	-	10	10
	H240	1	1	1	4	16	-	10	10
	H310	1	1	1	4	20	-	14	14
	H320	1	1	1	4	20	-	14	14

Metrica - design Bruno Fattorini

2016



AUTUMN

AUTUMN COLLECTIONS ARE SUBJECT TO "SPECIAL PRICE". PLEASE, ALWAYS CHECK THE AVAILABILITY WITH OUR SALES DEPARTMENT. AUTUMN FINISHES FOR OPEN CONTAINERS: NATURAL WOOD X027, NATURAL GREY WOOD X028 AND NATURAL BLACK WOOD X029.

The considerable span of the shelf in extruded aluminium, combined with the joining system have allowed to develop the system in length, making it modern and adjustable to any kind of environment.

Modular and flexible even thanks to the new kinds of storage units.

This can be with flap opening doors, drawers or open cabinet. They are simply resting inside the structure and are repositionable quite easily, thus allowing to meet any storage requirements as desired.

Structure

Uprights and shelves made of extruded aluminium and assembled together by using a concealed joining system, capable of giving the structure stability and a special resistance to loads.

Finish: matt lacquered white and graphite grey.

Typology

Available in a free-standing variant, always with a 33 cm depth. Frame in aluminium, section 1.5x1.5 cm, shelf 1.5 cm thick, available in the nominal length 60 cm, 90 cm and 120 cm. The end frames are equipped with an extruded aluminium pressure cap. Minima 42 comes in 5 heights: 49.5 cm, 93.5 cm, 137 cm, 181 cm and 225 cm; the first shelf is placed at 4.2 cm from the ground, while the uprights are equipped with adjustable feet in aluminium with a 0/+1.5 cm tolerance. Minima 42 is entirely made of 100% recyclable aluminium.

Cabinets

Elements made of MD-wood fibreboards, available in matt lacquered micro-goffered finish or in wood. They rest inside the structure.

Available in the nominal lengths: 30, 60, 90, and depth 33 cm, they are divided into the following categories:

Open units L30 cm

In MD- wood fibreboard, 8 mm thick, available in the matt lacquered micro-goffered finish in the following colour options: white, orange, avio blue, mustard yellow, green, dark red as well as in the natural wood variant, natural grey wood and natural black wood.

Units with flap opening door with or without lock - L60, L90 cm

In MD wood fibreboard, with variable thickness, available in the matt white lacquered micro-goffered finish as well as in the natural black wood variant. Door equipped with downward compass opening, with retractable mechanism with a stainless steel cable, shock-absorbing system, adjustable in intensity and strength in the closing and opening phases.

Two-drawer units with or without lock - L60 and L90 cm

In MD- wood fibreboards, with variable thickness, available in the matt white lacquered micro-goffered finish as well as in the natural black wood variant. Double drawer equipped with push-pull system while opening, with totally-extractable guides.

Locks

With a universal key

With the same key you can open any unit with lock.

With a cipher key

This is for opening exclusively doors/drawers in the same unit.

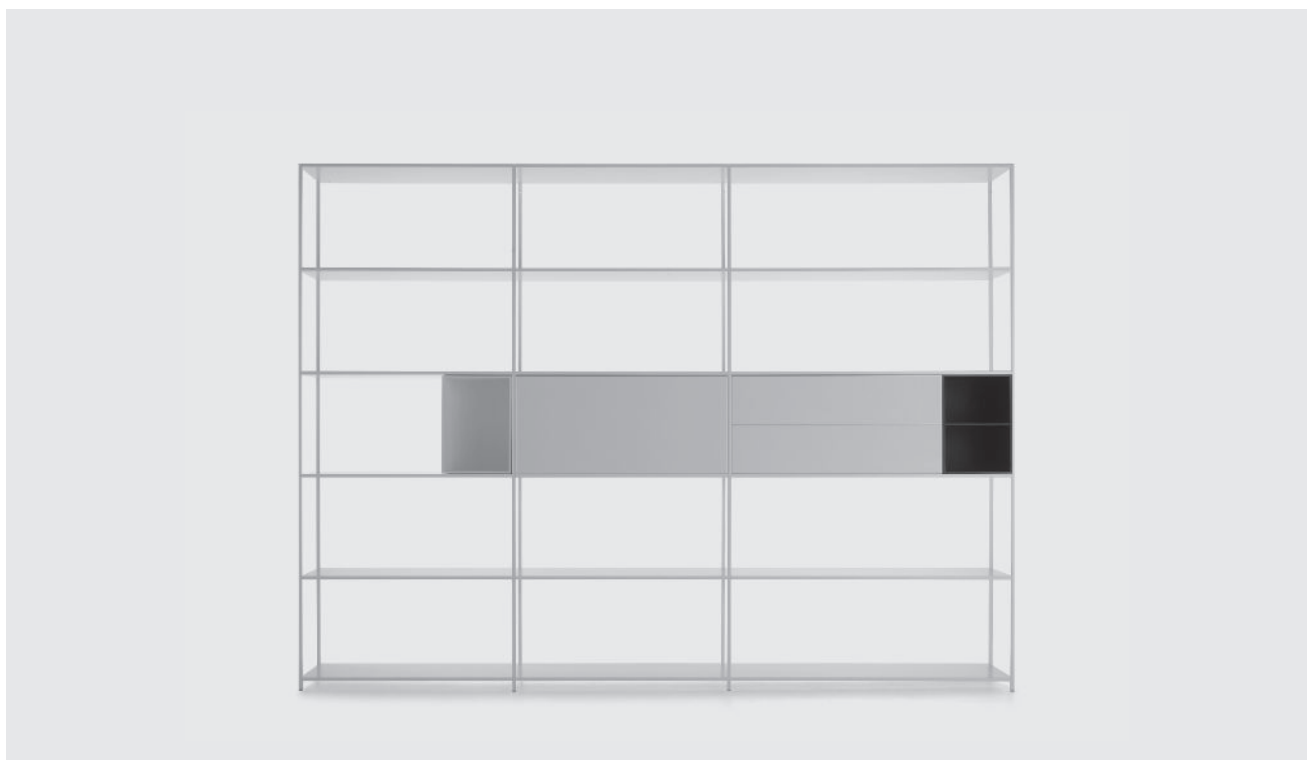

Notes for the assembly and feasibility

- A drawing of the composition is to be sent together with your order.
- For a proper use, we suggest to position the drawers at the bottom of the unit.
- To use this system (H137 - H181 - H225) as a room divider for work environments, it is mandatory to join two structures together so as to obtain a ground depth of 66 cm to ensure a proper stability to the system. The screws for the joining are included in the installation kit.
- For a proper assembly, please carefully follow the instructions attached to the product.
- We always recommend wall mounting of Minima in heights 225 / 181cm. The wall end frames are provided with holes for the wall fixing.

! PLEASE NOTE
WITH CONFIGURATIONS OTHER THAN WHAT PROPOSED AS WELL AS FOR SPECIAL COMPOSITIONS FLANKED AT DIFFERENT HEIGHTS, PLEASE ASK THE SALES DEPARTMENT TO CONFIRM FEASIBILITY.

Regulations

For regulations ISO and UNI EN, please refer to the technical section at the end of the price list.

Finishes	Frames and shelves
F008	matt painted white X053
F051	matt painted graphite grey X054

Finishes	Cabinets
F008	matt lacquered white X042
F050	natural black wood X029 AUTUMN
*F043	matt lacquered orange X047
*F046	matt lacquered green X049
*F052	matt lacquered avio blue X050
*F053	matt lacquered mustard yellow X048
*F054	matt lacquered dark red X046
*F048	natural wood X027 AUTUMN
*F049	natural grey wood X028 AUTUMN

*only for open cabinet

For further information about specs, please refer to the technical section at the end of the price list (tables of materials/colours).

Abacus

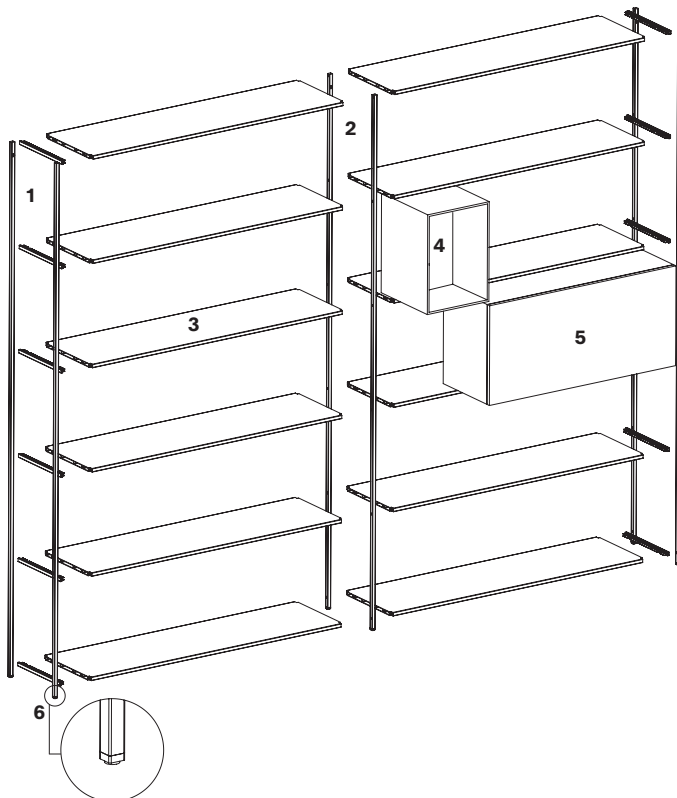

Minima 42

- 1 free-standing end frame, completed with fittings
- 2 free-standing intermediate frame
- 3 shelf
- 4 open cabinet, L30
- 5 cabinet
- 6 adjustable feet

5 heights:

- H49.5
- H93
- H137
- H181
- H225

the first shelf is placed at 4.2 cm from the ground, while the uprights are equipped with adjustable feet in aluminium with a 0/+1.5 cm tolerance.

Finishes sheets



Configurator



FOR INFORMATION ON THE MINIMA CONFIGURATOR KINDLY REFER TO THE FIRST PAGE OF THE MINIMA 3.0 SECTION IN THE PRICE-LIST.

Minima 42

3

EU - PRICE LIST 2023/24 - € - VAT EXCLUDED

Abacus

Cabinets D33

In the price list the lengths and heights of the cabinets are approximate and correspond to the inner usable space of the bookcase.

Open cabinet L30



nominal L30 H42
real L29.6 H41.9

Cabinets with flap opening door L60/90



nominal L60 H42
real L59.6 H41.9

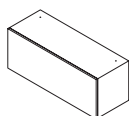

nominal L90 H42
real L89.6 H41.9

Cabinets with two drawers L60/90

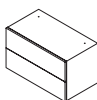

nominal L60 H42
real L59.6 H41.9

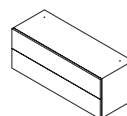

nominal L90 H42
real L89.6 H41.9

Lock for cabinet

Flap door



Drawers

For the cabinets with two drawers, the lock can only be put on the top drawer.

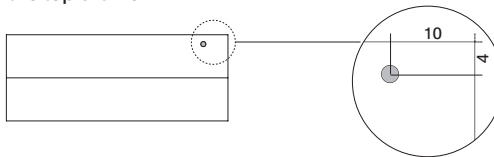

Example for element positioning

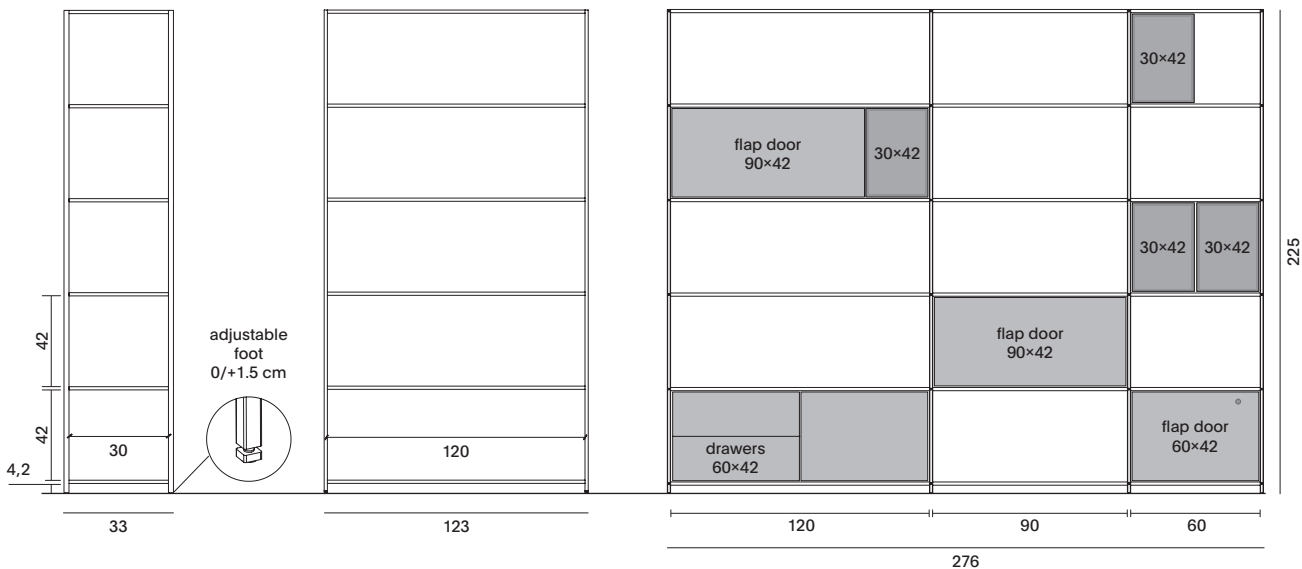

Minima 42

3

EU - PRICE LIST 2023/24 - € - VAT EXCLUDED

Abacus

Shelves

In the price list the shelving lengths are approximate and correspond to the inner usable space of the bookcase.

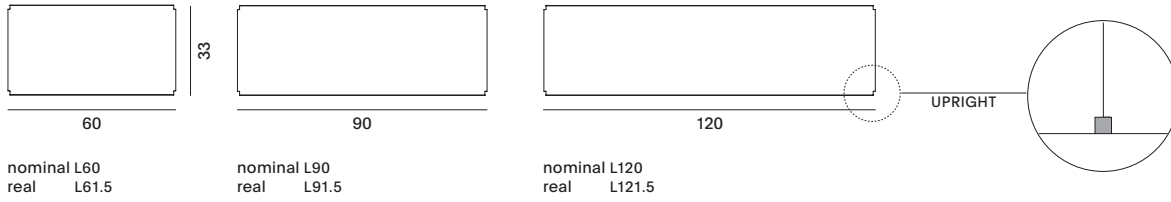

Heights

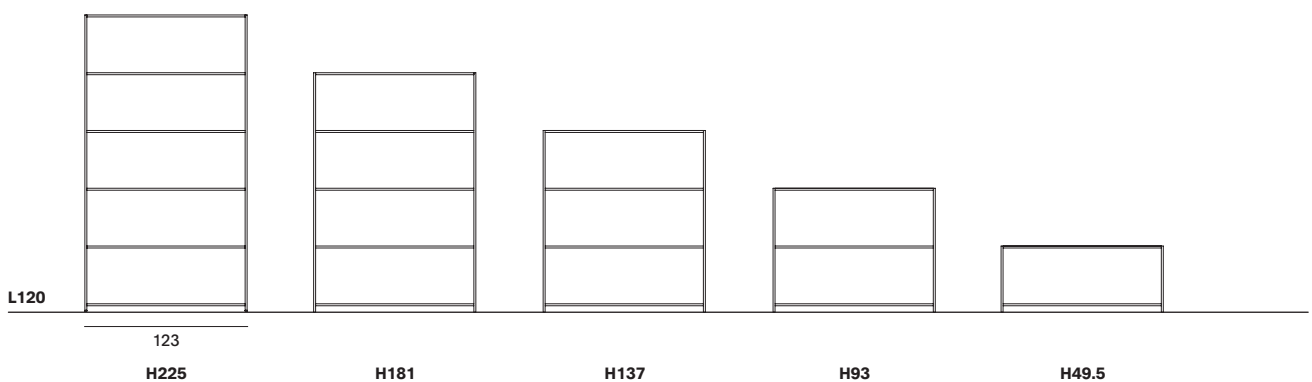
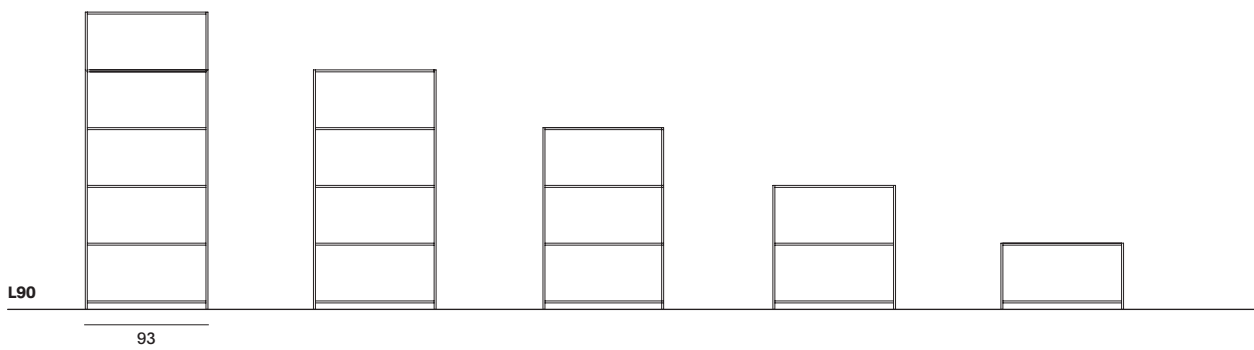
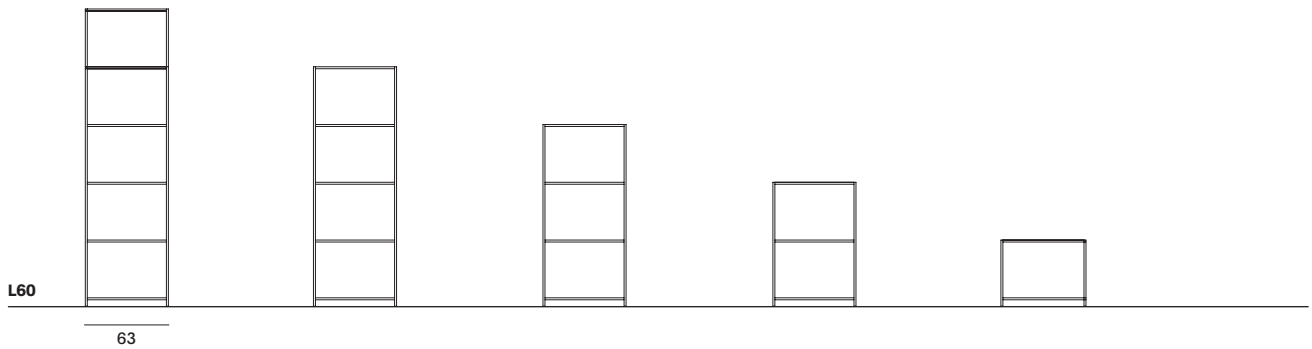

Pentagramma is the new living system designed by Pitsou Kedem for MDF Italia, a design with a strong personality that interprets the concept of the day system with sophistication by focusing on the value of lightness. Surprisingly simple to compose and install, the design develops from an extruded aluminium panel fixed to the wall, on which various elements, containers or shelves are hung. Its name was inspired by its construction: the wall-mounted back panel to which the accessories are hung to create the composition looks like a music stave or pentagramma in Italian, on which the notes are written to compose a tune. Extremely flexible and versatile, this system offers the possibility of reconfiguring the layout over time. Just a few elements are enough to obtain infinite combinations that fulfil different functions and situations of use, fitting seamlessly and with versatility into all residential and contract environments: in fact, it offers a valid storage solution for walls in the living area and office, but also for creating compositions in the sleeping area.

Backest

The wall-mounted panel, the load-bearing structure of the whole system, is made of 20 mm thick extruded aluminium and available in various lengths (L150, L200 and 2L50 cm). The panels can be fixed to the wall using the aluminium bar provided, onto which the hidden panel brackets are hung. It can all be adjusted in three directions: horizontally, vertically and also frontally (sloping away from the wall). The panels are completely covered in veneered wood, available in two finishes: bleached oak and Canaletto walnut. Horizontal wood grain.

The panels can be placed side by side horizontally. Whereas vertically there must always be a 5-cm gap between one panel and another to allow for attachment of the shelf or open unit modules.

Shelves

The shelves are made from a single piece of 8 mm thick extruded aluminium.

A really simple intuitive system uses the cross-section of the shelves themselves to hang them on the wall-mounted panels so that the various modules can be arranged and positioned as required. An anchoring system is provided for safety.

The various modules are available in a liquid paint finish in matt colours: white, lead black and shadow grey.

The shelves are available in only one height but in various lengths (L60, L90 and 1L20 cm). The system is rounded out by a divider (left or right), designed to add movement to possible configurations.

Open storage units

The open units are available in only one height but in various lengths (L30, L60 and L90 cm).

The L90 modules have an internal divider (right or left) that separate the space creating a partition, like the musical notes on a stave. The materials used are extruded aluminium for the back of the units, while the rest of the structure is made of panels in medium density wood fibre, laminated with aluminium to increase the resistance and sturdiness of the unit. All the open units are liquid painted in matt colours: white, lead black, shadow grey, burgundy red, English green, dune and blue to match the rest of the MDF Italia collection.

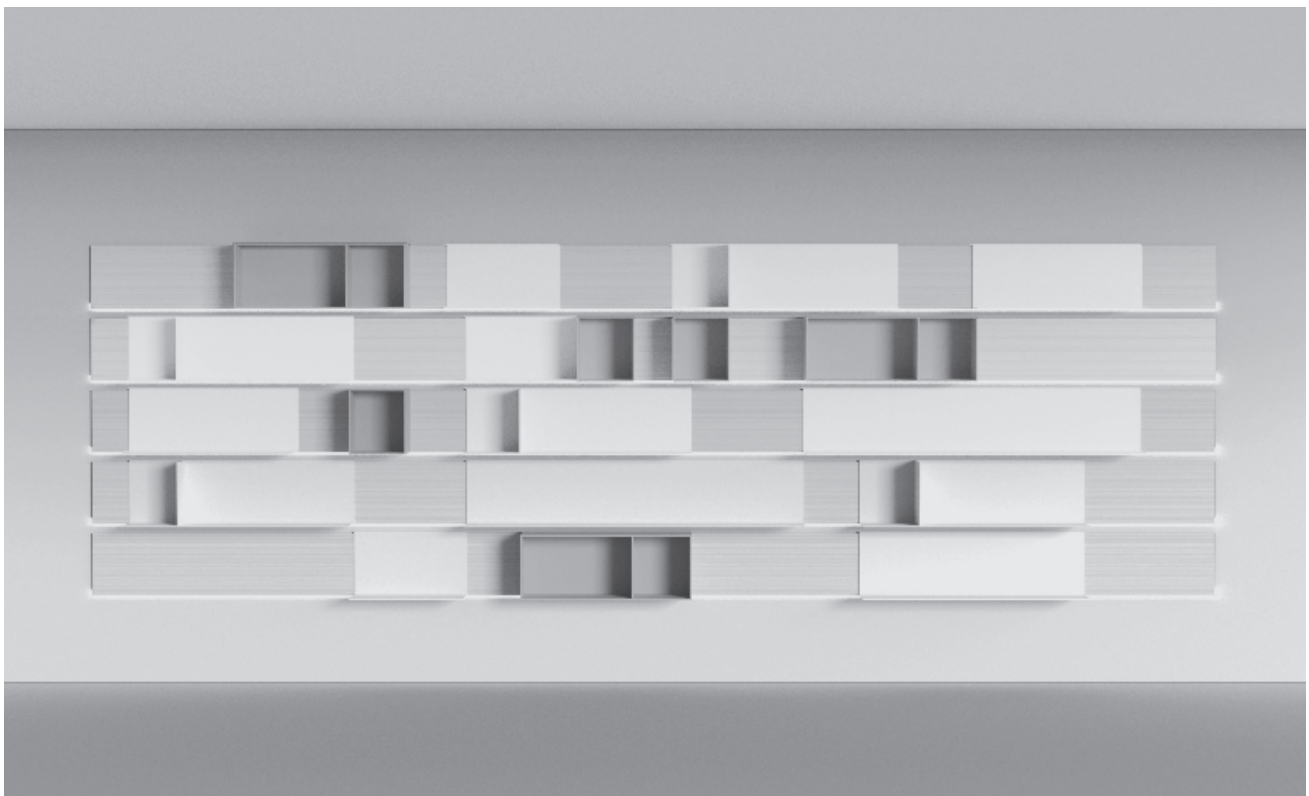

LED lighting

The LED system can be ordered as an accessory to fit to the lower part of the wall-mounted panels. Each panel can be fitted with the LED bars and will be provided with its own junction box and power supply unit.

Colour temperature 2700° K. Can be switched on/off using a remote control or dedicated app.

Accessories

- Remote control for LED complete composition.
- External finishing caps (pair). Three colors: lead gray, shadow gray, white.



PLEASE NOTE

A REMOTE CONTROL REGULATES THE LIGHTING OF THE WHOLE COMPOSITION.

FINISHING CAPS ARE TO BE ORDERED SEPARATELY AND ARE TO BE APPLIED IN THE END PARTS OF THE PREFIGURED COMPOSITIONS.

THE PANELS CANNOT BE COMBINED VERTICALLY. LEAVE A DISTANCE BETWEEN THEM OF AT LEAST 5 CM TO ALLOW THE HOOKING OF THE SHELF MODULES OR OPEN COMPARTMENTS.

Finishes	Back panel
F040	bleached oak X075
F135	canaletto walnut

Finishes	Shelves
F008	matt painted white X053
F190	painted matt lead black X138
F126	matt painted shadow grey X122

Finishes	Open unit
F008	matt painted white X053
F190	painted matt lead black X138
F126	matt painted shadow grey X122
F191	matt painted burgundy
F192	matt painted English green
F193	matt painted dune
F178	matt painted navy blue

For further information about specs, please refer to the technical section at the end of the price list (tables of materials/colours).

Finishes



Abacus

back panel, wall-mounted panel

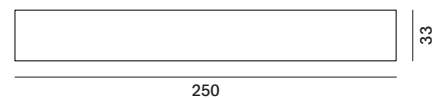
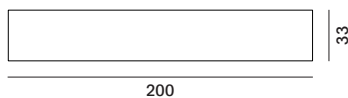
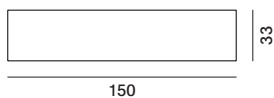

shelves



L60 D33 H34

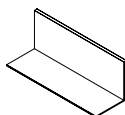

L90 D33 H34

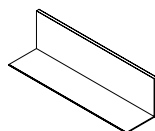

L120 D33 H34

shelves with L/R divider

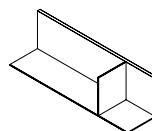

L120 D33 H34

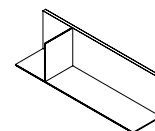

open unit



L30 D33 H34



L60 D33 H34

open unit with L/R divider

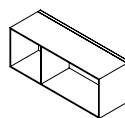

L90 D33 H34

