



GRID

DESIGNED BY GLENN MARYS

tossB

PRODUCT INFORMATION

GRID ARM 1 WITH 1 SPOT

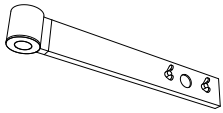

LAMP TYPE	LED
COLOUR TEMP.	2700K
WATTAGE	4W
VOLTAGE	350mA
LUMEN	400
GEAR	NOT INCLUDED
CLASS	2

ORDER CODE

BLACK ANODIZED	T108P1DZL
WHITE PAINTED	T108P1DWL

GRID ARM 2 WITH 1 SPOT

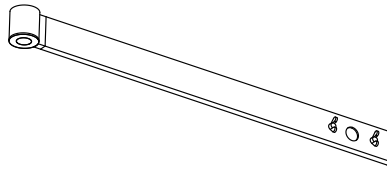

LAMP TYPE	LED
COLOUR TEMP.	2700K
WATTAGE	4W
VOLTAGE	350mA
LUMEN	400
GEAR	NOT INCLUDED
CLASS	2

ORDER CODE

BLACK ANODIZED	T108P2DZL
WHITE PAINTED	T108P2DWL

GRID ARM 3 WITH 1 SPOT

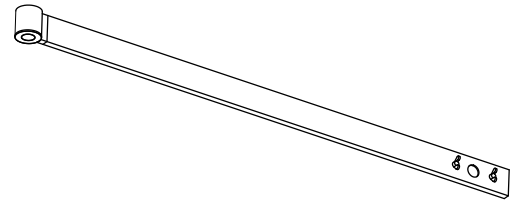

LAMP TYPE	LED
COLOUR TEMP.	2700K
WATTAGE	4W
VOLTAGE	350mA
LUMEN	400
GEAR	NOT INCLUDED
CLASS	2

ORDER CODE

BLACK ANODIZED	T108P3DZL
WHITE PAINTED	T108P3DWL

GRID ARM 1 WITH 2 SPOTS

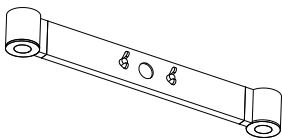

LAMP TYPE	LED
COLOUR TEMP.	2700K
WATTAGE	2x4W
VOLTAGE	350mA
LUMEN	2x400
GEAR	NOT INCLUDED
CLASS	2

ORDER CODE

BLACK ANODIZED	T108P4DZL
WHITE PAINTED	T108P4DWL

GRID ARM 2 WITH 2 SPOTS

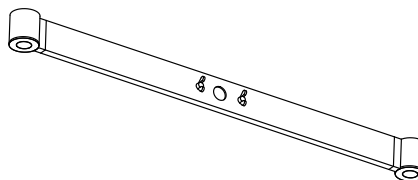

LAMP TYPE	LED
COLOUR TEMP.	2700K
WATTAGE	2x4W
VOLTAGE	350mA
LUMEN	2x400
GEAR	NOT INCLUDED
CLASS	2

ORDER CODE

BLACK ANODIZED	T108P5DZL
WHITE PAINTED	T108P5DWL

GRID ARM 3 WITH 2 SPOTS

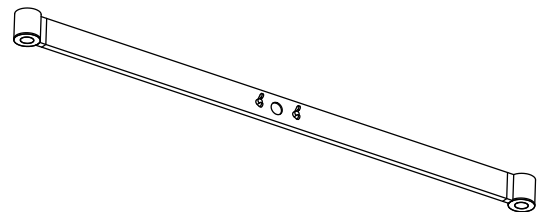

LAMP TYPE	LED
COLOUR TEMP.	2700K
WATTAGE	2x4W
VOLTAGE	350mA
LUMEN	2x400
GEAR	NOT INCLUDED
CLASS	2

ORDER CODE

BLACK ANODIZED	T108P6DZL
WHITE PAINTED	T108P6DWL

GRID CONNECTION PIECE 50CM

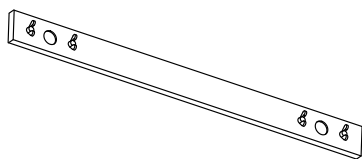

GRID CONNECTION PIECE 75CM

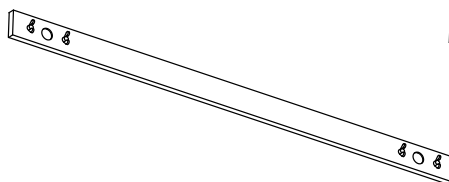

GRID CONNECTION PIECE 100CM

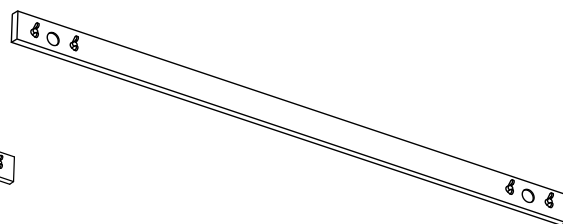

ORDER CODE

BLACK ANODIZED	T108P7DZL
WHITE PAINTED	T108P7DWL

ORDER CODE

BLACK ANODIZED	T108P8DZL
WHITE PAINTED	T108P8DWL

ORDER CODE

BLACK ANODIZED	T108P9DZL
WHITE PAINTED	T108P9DWL

GRID BASE A WITH DRIVER

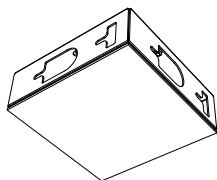

GRID BASE B WITH DRIVER

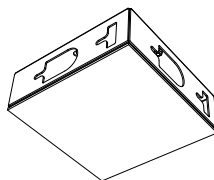

GRID BASE DALI WITH DRIVER

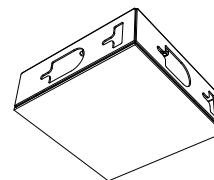

LAMP TYPE	LED
GEAR	INCLUDED (TRIAC)
WATTAGE	3 OR 4 SPOTS 4W
CLASS	1

LAMP TYPE	LED
GEAR	INCLUDED (TRIAC)
WATTAGE	MAX. 2 SPOTS 4W
CLASS	1

LAMP TYPE	LED
GEAR	INCLUDED (DALI)
WATTAGE	MAX. 4 SPOTS 4W
CLASS	1

ORDER CODE

BLACK ANODIZED	T108C1DZL
WHITE PAINTED	T108C1DWL

ORDER CODE

BLACK ANODIZED	T108C2DZL
WHITE PAINTED	T108C2DWL

ORDER CODE

BLACK ANODIZED	T108C1DZLD
WHITE PAINTED	T108C1DWLD

ARMS 1 SPOT

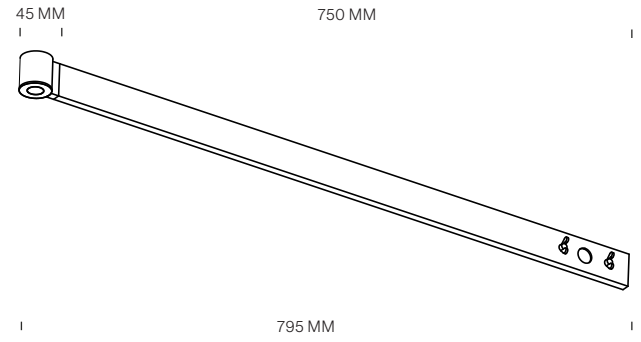
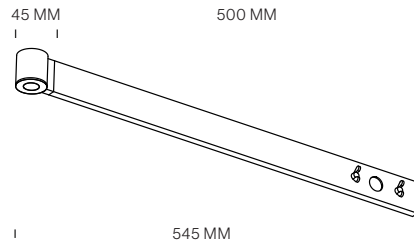
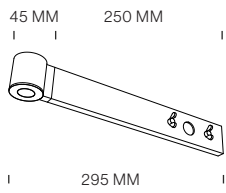

ARMS 2 SPOTS

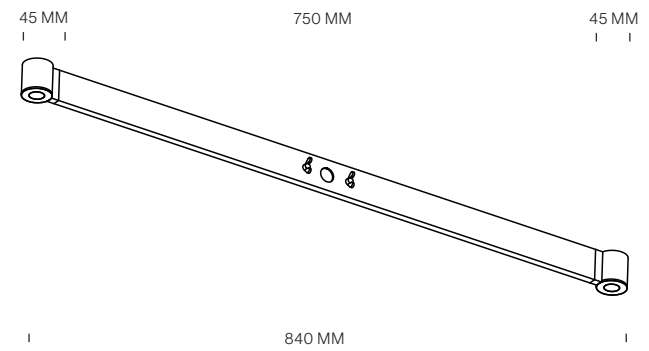
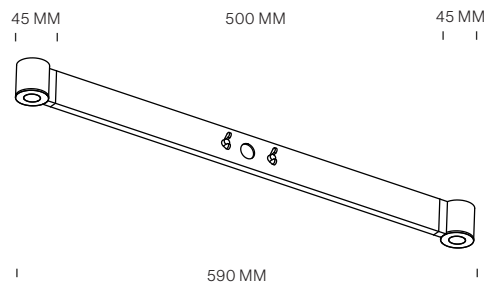
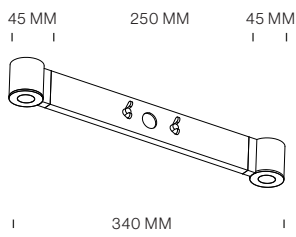

CONNECTION PIECES

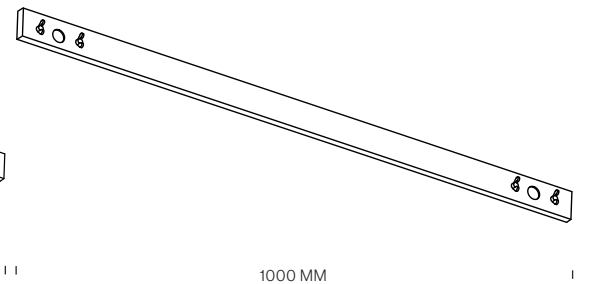
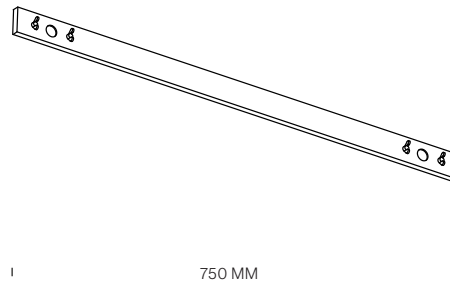
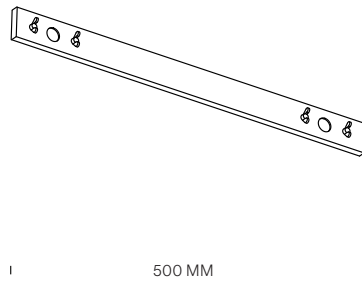

BASE WITH DRIVER

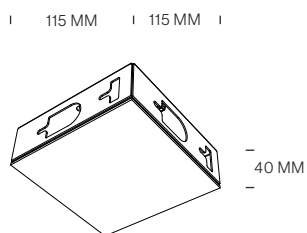

EXAMPLES - HOW TO ORDER

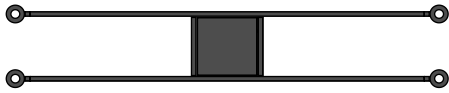

=

2x T108P6D..
1x T108C1D..

1x T108P1D..
2x T108P2D..
1x T108P3D..
1x T108C1D..

=

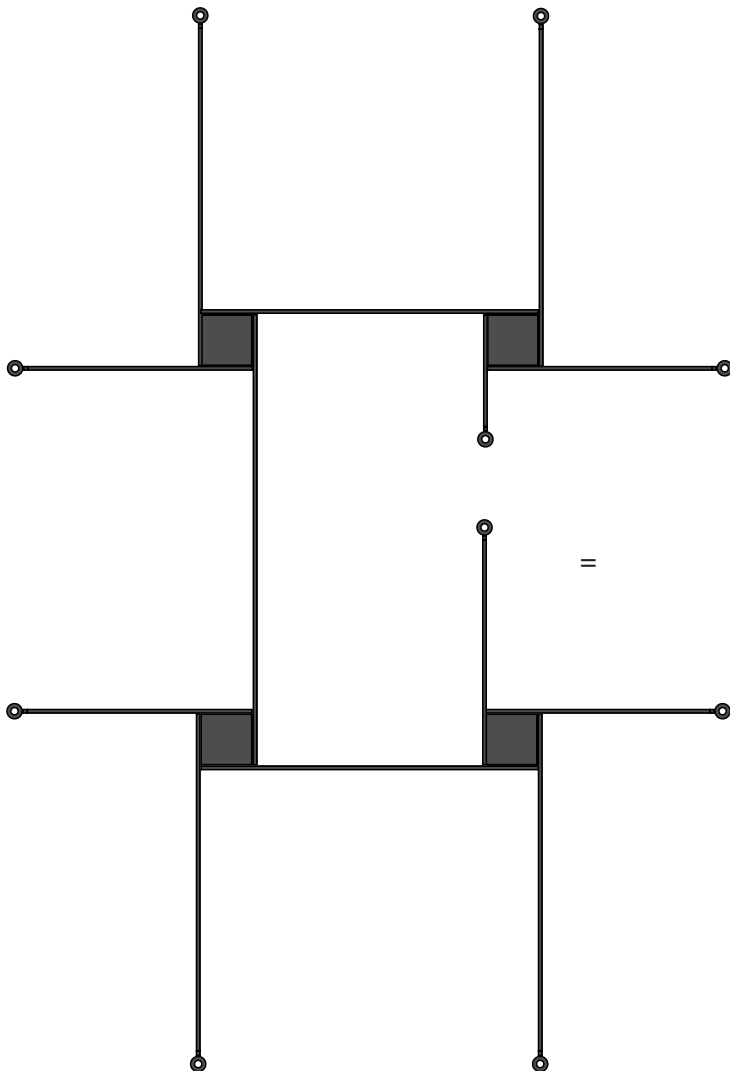
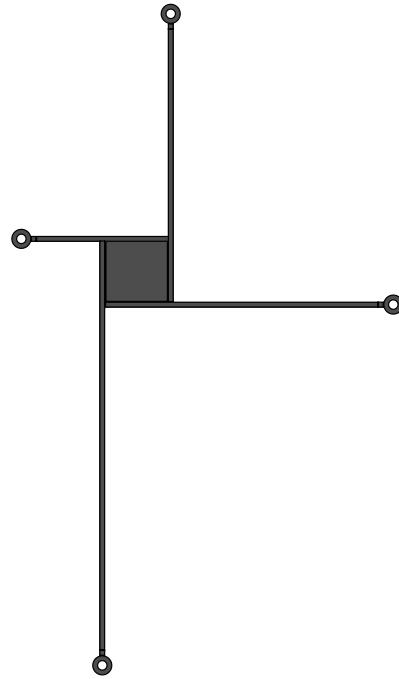

=

4x T108P3D..
5x T108P2D..
1x T108P1D..
2x T08P8D..
1x T108P9D..
2x T108C1D..
2x T108C2D..

tossB

TOSSB.COM
CREATORS OF LIGHTING UNITS