

AÏKU / AÏKU SOFT

Jean Marie Massaud
2016-2018



AÏKU comes from the Japanese word “haiku” and it means a short poem generally composed of three verses. Wonderful poems that in a few words express remarkable meanings; a simple poem, with no lexical frills and conjunctions, taking its strength from suggestions. Due to its incredible shortness, it requires a considerable synthesis of thought and image.

The meaning and the sound of this word reveal the project's concept, to reconcile the paradoxes of uses and sensitiveness. AÏKU can be radical, but at the same time is a refined architecture designed for domestic environments, as well as offices and public spaces.

A collection of highly comfortable chairs featuring an essential image, designed for both home and contract spaces. Available in six versions of bases and a wide range of finishes.

Two-colour shell

Shell made from two-colour polypropylene through injection-moulding, mass pigmented with double finish; gloss outside, in black and white colours, inside with matt saffiano effect in different colours.

Gloss white external shell, inside:

- light grey
- sugar paper blue
- olive green
- dove grey

Gloss black external shell, inside:

- dark grey
- military green

Bases for two-colour shell

The lacquered bases (white and black matt) are supplied in the same colour of the shell's external finish. In addition, the new chromed base is now available for both shells.

Bases available:

- **4-legged round-shaped base in steel tube**, painted matt white, matt graphite grey or chrome-plated;
- **sled base in steel wire**, painted matt white, matt graphite grey or chrome-plated;
- **sled base in steel wire with armrests**, painted matt white, matt graphite grey or chrome-plated;
- **sled base in steel wire with armrests and table**, painted matt white, matt graphite grey or chrome-plated. HPL 10mm thick table arm available in matt white or matt black;
- **4-legged tapered base** with injection-moulded tube in rectangular section, painted matt white, matt graphite grey or chrome-plated;
- **4-legged base in solid oak** with a natural, bleached or brown finish.

Versions with 4-legged round-shaped base, sled bases and 4-legged tapered base are stackable.

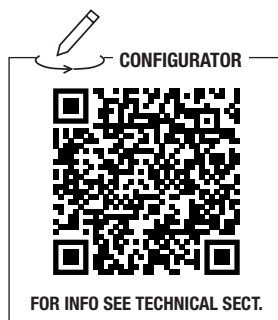

	EXTERNAL SHELL	INSIDE SHELL			
WHITE VERSION	gloss white	sugar paper blue X087	olive green X088	light grey X089	dove grey X090
BLACK VERSION	gloss black	dark grey X091	military green X092		

AÏKU / AÏKU SOFT

Jean Marie Massaud



Padded shell

Injection moulded polypropylene body, cold moulded padding shaped and applied on the load-bearing piece.

The cover is not removable and covers the armchair completely.

Customer's fabric: feasibility, prices and delivery times are to be agreed and verified with the sales department.

To select a suitable fabric for each product, please refer to the technical section at the end of the price list or to the product sheets available in the website.

Bases for padded shell:

- **4-legged round-shaped base in steel tube**, painted matt white, matt graphite grey or chrome-plated;
- **sled base in steel wire**, painted matt white, matt graphite grey or chrome-plated;
- **sled base in steel wire with armrests**, painted matt white, matt graphite grey or chrome-plated;
- **sled base in steel wire with armrests and table**, painted matt white, matt graphite grey or chrome-plated. HPL 10 mm thick table arm available in matt white or matt black;
- **4-legged tapered base** with injection-moulded tube in rectangular section, painted matt white, matt graphite grey or bright black chrome and gold.
- **4-legged base in solid oak** with a natural, bleached or brown finish.

Versions with 4-legged round-shaped base, sled bases and 4-legged tapered base are stackable. (*).

Optional accessories

Injection moulded under-seat for better stacking.

(* Note: the AÏKU SOFT version is not stackable unless the specific "stacking under-seat" is used. This accessory can be applied on all bases of the range (excluding the wooden base) and allows for the weight of a maximum number of 4 chairs.

FLAME RETARDANT PADDING

Norms 11M, California TB 117-2013 and BS are available upon request with a surcharge as of +5%. Feasibility, costs and delivery times to be verified with our Sales Dept.

NB: the use of flame retardant polyurethanes and interliner can give a different result from the standard.

For the choice of the upholstery and its feasibility according to any norms, please refer to the technical section at the end of the price list.

Accessories for AÏKU and AÏKU SOFT (*):

- **Trolley**
aluminium grey epoxy painted steel frame, with pirouetting castors matching the frame; maximum capacity 15 pieces.
- **Hook for 4-legged base* - sled base* - 4-legged tapered base***
dedicated hooking system for seat alignment, made of stiff PA6 plastic, in the colours white and black.
- **Place marker***
dedicated numbering system with magnet hook, in stiff PA6 plastic, in the colours white and black. For 4-legged round-shaped base and sled base. For number definition, lead time and feasibility, please contact our Sales Department.
- **Padded Pad**
Thermoformed cushion, size 47.8 x 43.5 cm, 1.5 cm thick, with BS flame-retardant polyurethane padding and combined with welded fabric; non-slip PES-PU coat underneath. This technical manufacturing detail enhances both graphics and padding with a 3D effect, ensuring quality and a long lasting product. Considering the special features, the cover is not removable.
Cushion available with LONDRA fabric cover in the colours white col. 01 and black col. 07.

Ref. regulations ISO and UNI EN, please refer to the technical section at the end of the price list.

For specifications and sizes, please consult the following pages.



AÏKU / AÏKU SOFT

VERSIONS

**4-legged
round-shaped base**

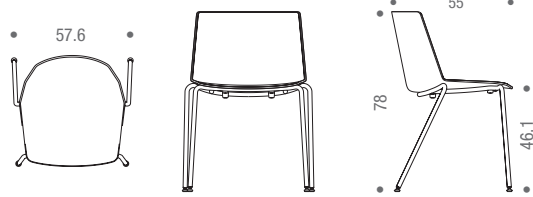

STACKABILITY

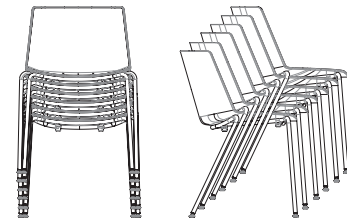

x 6
The cart allows stacking up to 15 pcs.

sled base

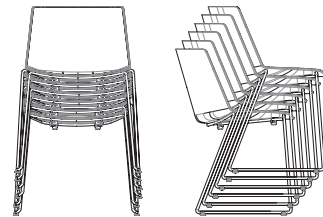

x 6
The cart allows stacking up to 15 pcs.

**sled base
with armrests**

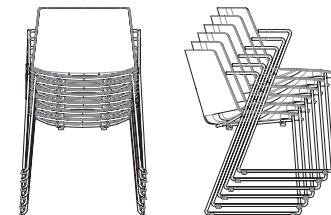
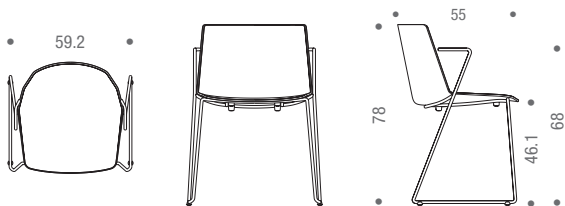

x 6
The cart allows stacking up to 15 pcs.

**sled base
with table**

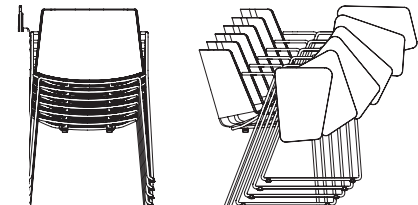
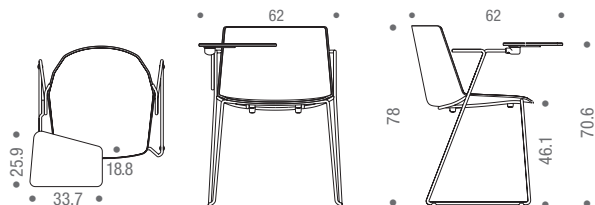

x 6

**4-legged
tapered base**

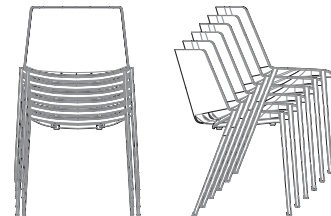
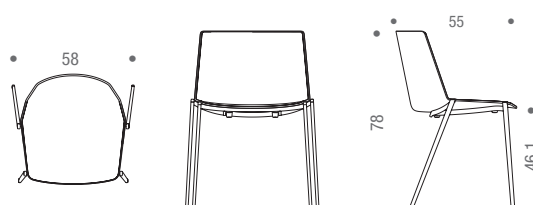

x 6
The cart allows stacking up to 15 pcs.

4-legged oak base



AÏKU / AÏKU SOFT

VERSION

STACKABILITY

4-legged round-shaped base

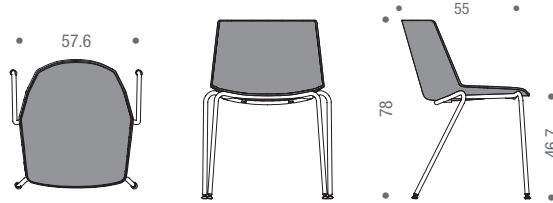

sled base

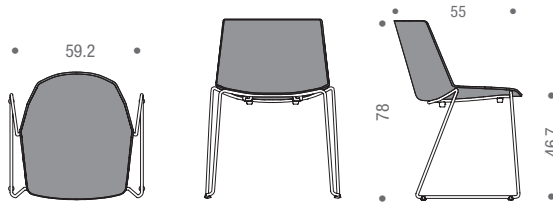

max 4 pcs for:

4-legged round-shaped base, sled base, sled base with armrests, sled base with table, 4-legged tapered base (excluding the wooden base).

sled base with armrests

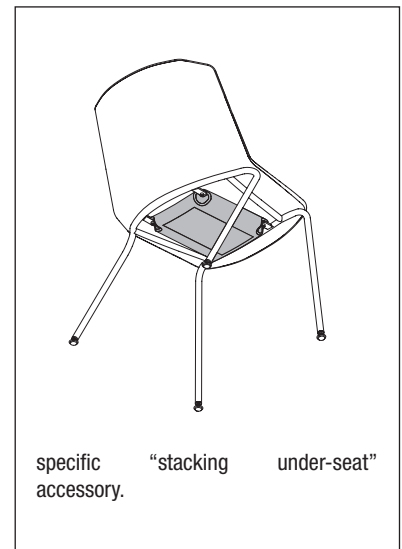
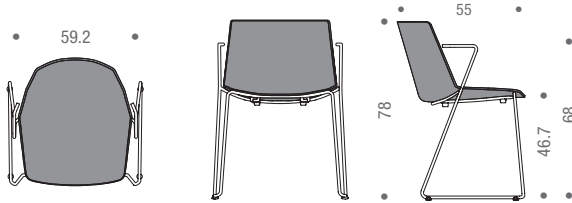

sled base with table

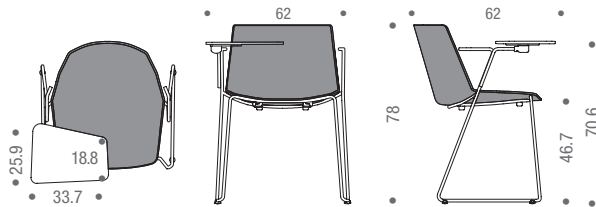

4-legged tapered base

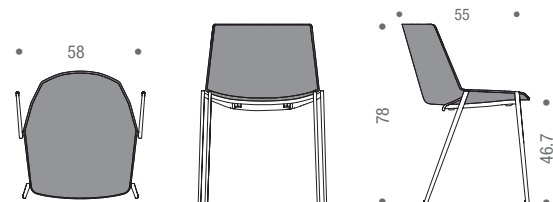

4-legged oak base

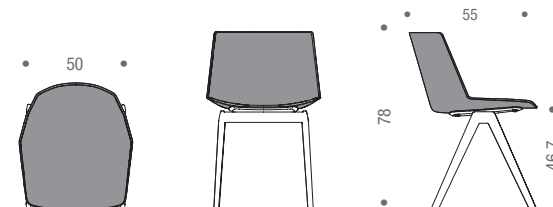

AÏKU / AÏKU SOFT

TROLLEY (MAX 15 PCS)

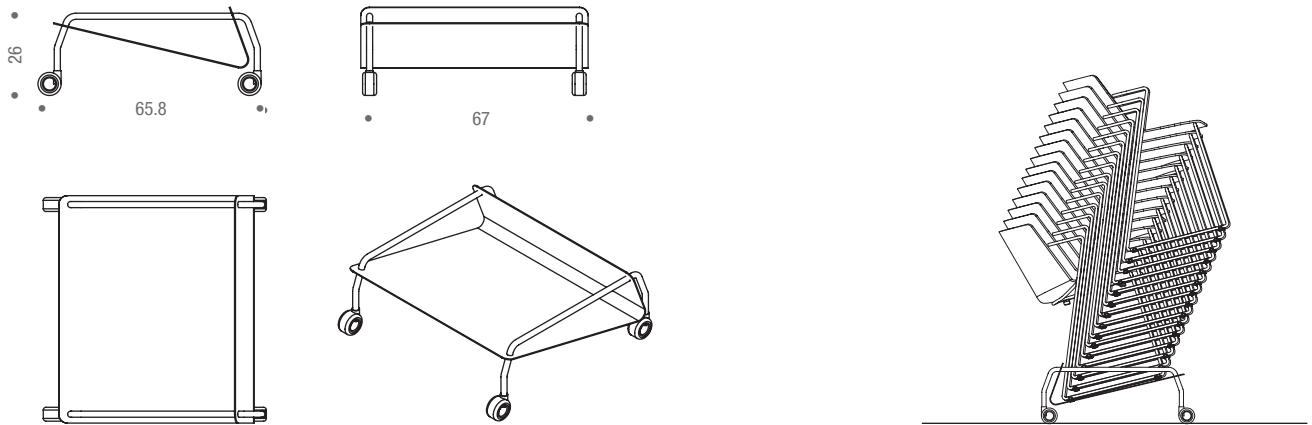

MARKER FOR 4-LEGGED ROUND-SHAPED BASE AND SLED BASE

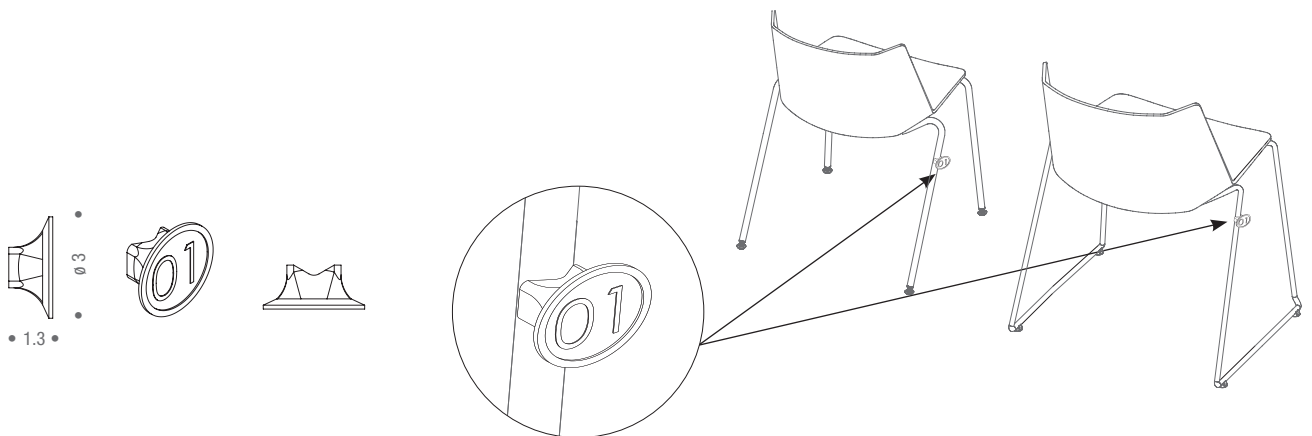

PADDED PAD FOR AÏKU



AÏKU / AÏKU SOFT

HOOK FOR 4-LEGGED BASE

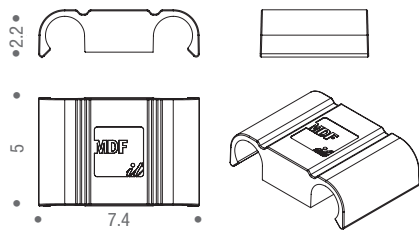

HOOK FOR SLED BASE

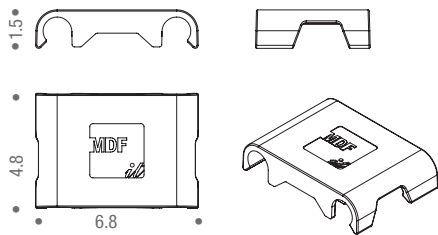

HOOK FOR 4-LEGGED TAPERED BASE

