

Jean Marie Massaud
2018



Armchair and sofa with strong personality and large cushions, providing considerable comfort and great functionality. Available in two different seat depths, and in two different backrest heights, which guarantee a comfortable sitting position and strong adaptation to the needs and requirements of the moment.

Cushions

Backrest and armrest with internal load-bearing structure in tubular aluminium and a particular system for fastening to the profile. Variable-density foam polyurethane padding and cover in Rollo Fill® (polyester microspheres) and polyester wadding. This particular composition of the cushion gives the padding natural softness and elasticity, a long lifespan and high comfort. Cushions with topstitched seams and raised profiles.

Frame

Extruded aluminium frame with elastic bands, diecast aluminium feet. The frame is painted matt white, bronze and black nickel.

Poufs

The collection includes three new pouf models: L75xD75, L150xD75 and L150xD44 with frame H30 cm, always in the same finish as the sofa.

Cover

The upholstery in fabric or leather covers every part of the sofa and is completely removable.

Optional extra covers are available if required. All units in leather may have, depending on their size and at MDF Italia's discretion, one or more seams.

To select a suitable fabric for each product, please refer to the technical section at the end of the price list or to the product sheets available in the website.

With customer's own leather, in order that the product is properly manufactured, the leather piece must be larger than 5 sqm and with no defects, such as scars or holes.

Seams

These contrasting seams characterise and identify the Yale X collection, only for the high backrest variant. Available in the colours white, medium grey and anthracite, which can be selected and combined by the client.

FLAME RETARDANT PADDING

Norms 11M, California TB 117-2013 and BS are available upon request with a surcharge as of +5%. Feasibility, costs and delivery times to be verified with our Sales Dept.

NB: the use of flame retardant polyurethanes and interliner can give a different result from the standard.

For the choice of the upholstery and its feasibility according to any norms, please refer to the technical section at the end of the price list.

For further information about the coffee tables Yale Low Table, please refer to the coffee tables section.



Cushions with topstitched seams and raised profiles.



High backrest variant and contrasting seams.

FRAME FINISHES

S007 = matt painted white X053

S068 = matt painted bronze X100

S069 = matt painted black nickel X101

YALE X

VERSIONE STANDARD SCHIENALE BASSO

ARMCHAIR

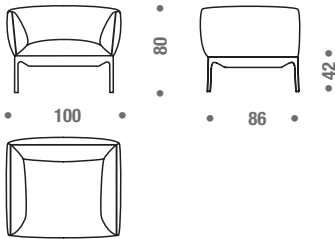

SOFA 2S

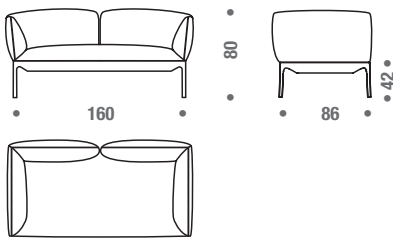

SOFA 3S

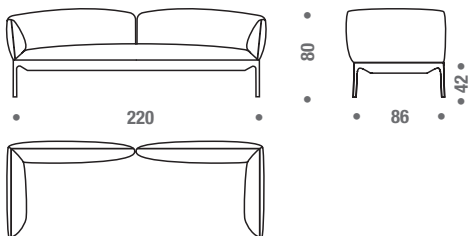

SOFA 3S EXTRA

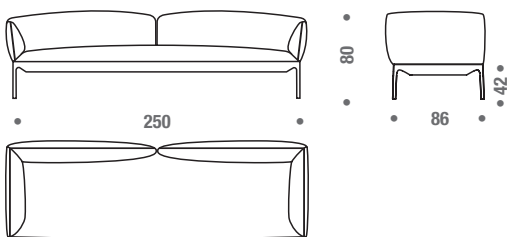

POUF

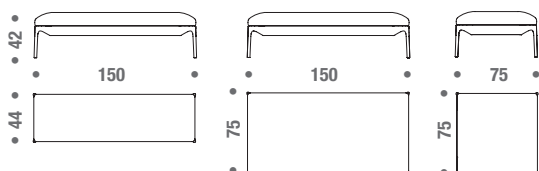

DEEP VERSION WITH LOW BACKREST

SOFA 3S

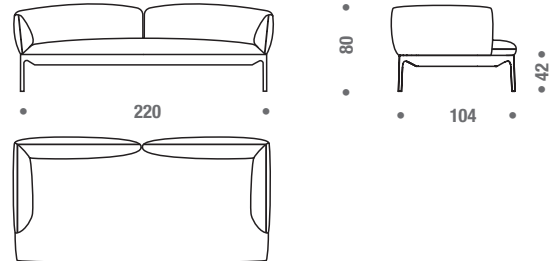

SOFA 3S EXTRA

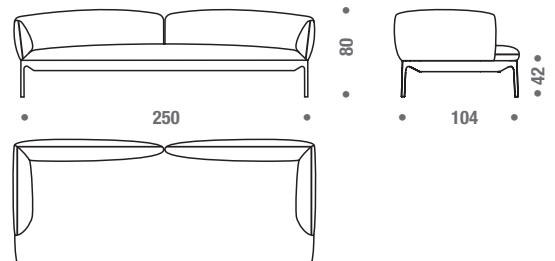

DEEP VERSION WITH HIGH BACKREST

SOFA 3S

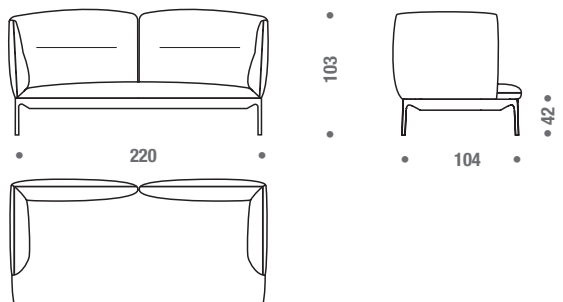

SOFA 3S EXTRA

