

Francesco Rota
2017



Cosy comes from the idea to offer high comfort with a reassuring, warm and familiar gesture. The timeless lines, soft and all embracing design, adaptability and versatile character make Cosy a padded item that offers the utmost comfort in a wide range of situations, environments and frameworks.

Collection of padded modular elements featuring seats with different depths and lengths; backs with different heights, either aligned or corner compositions; coffee tables and additional cushions.

A highly versatile system designed for consumers to choose their favourite composition that will meet their needs and blend into any setting, environment, style and taste.

Frame

Bearing frame made of solid and multilayer wood, base with elastic belts, feet and concealed hook system.

Padding: variable-density foam polyurethane padding and cover in polyester wadding.

Cover

The fabric covering every part of the sofa is manufactured to enhance the softness of the sofa. In addition, the covers are completely removable.

An extra cover can be purchased for both the upholstered sectionals and the cushions.

IMPORTANT: The leather option is available just for the decorative loose cushions.

To select a suitable fabric for each product, please refer to the technical section at the end of the price list or to the product sheets available in the website.

For further information about coffee tables (Cosy Low Table 1 - 2), please refer to the coffee tables section.

Additional cushions

- Square cushion **60x60cm** with down filling and lateral strip
- Square cushion **50x50cm** with down filling and lateral strip
- Rectangular cushion **75x40cm** with down filling and lateral strip
- Lower back cushion **75x25cm** with down filling and lateral strip.

FLAME RETARDANT PADDING

Norms 11M, California TB 117-2013 and BS are available upon request with a surcharge as of +5%. Feasibility, costs and delivery times to be verified with our Sales Dept.

NB: the use of flame retardant polyurethanes and interliner can give a different result from the standard.

For the choice of the upholstery and its feasibility according to any norms, please refer to the technical section at the end of the price list.



COSY

2S sofa

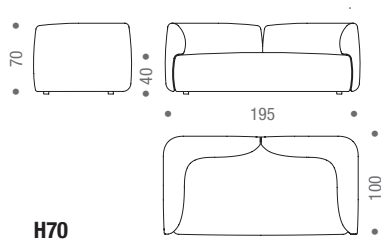

H70

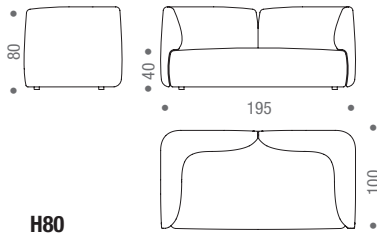

H80

deep sofa

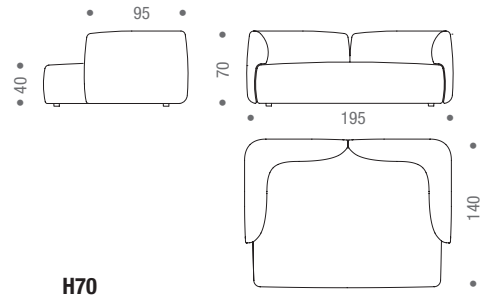

H70

3S sofa

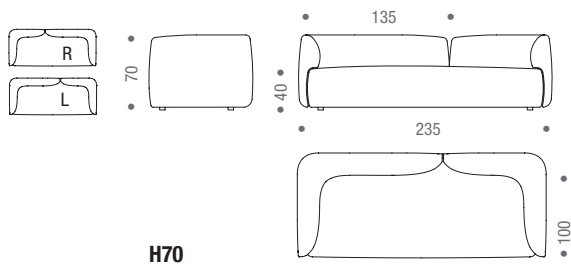

H70

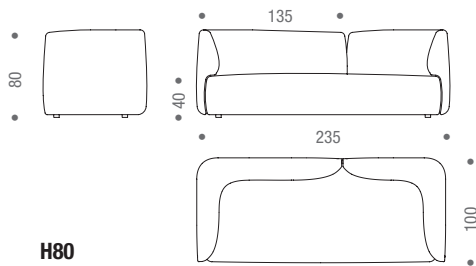

H80

Paolina sofa

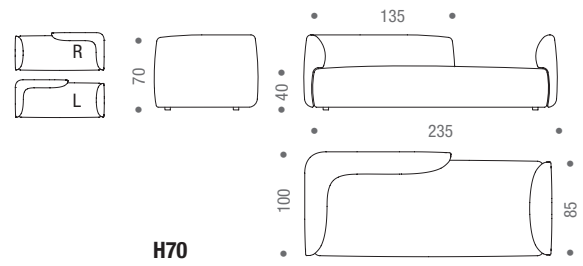

H70

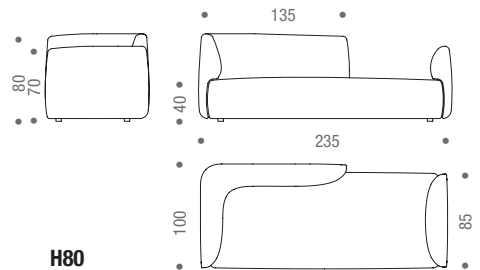

H80

Visavi sofa

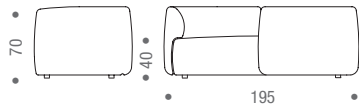

H70

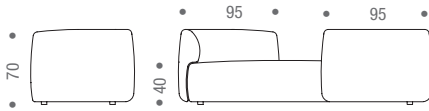
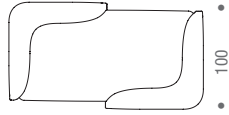

H70

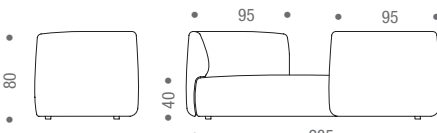
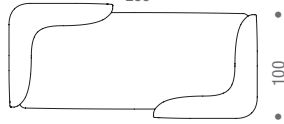

H80

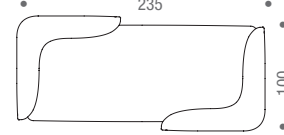

padded modular element S

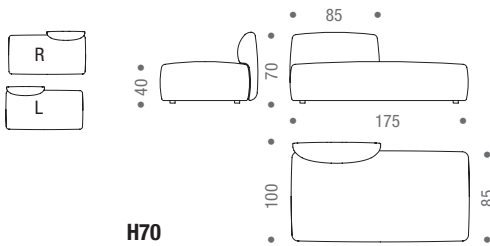

H70

padded modular element M

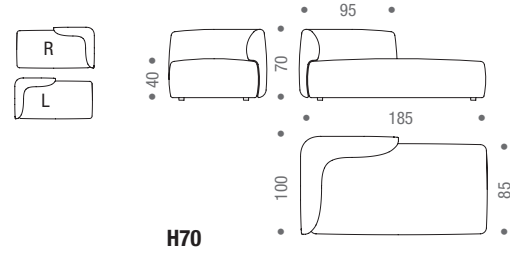

H70

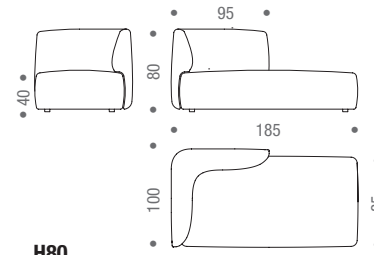

H80

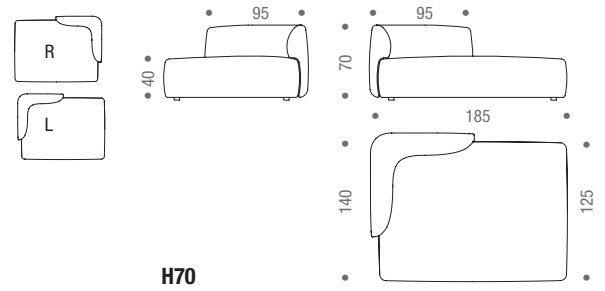

H70

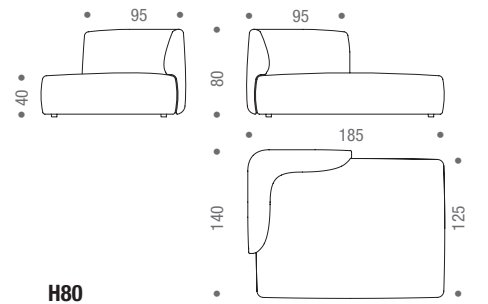

H80

COSY

padded modular element L

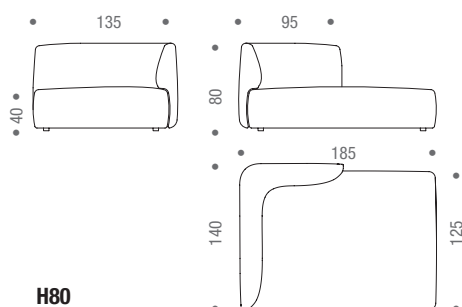
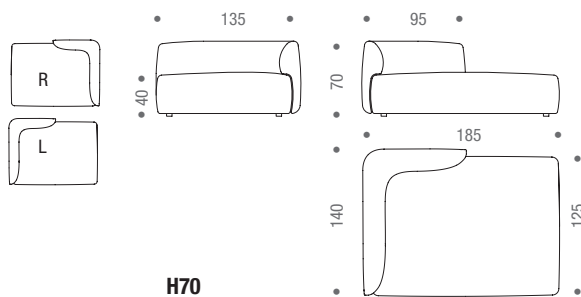
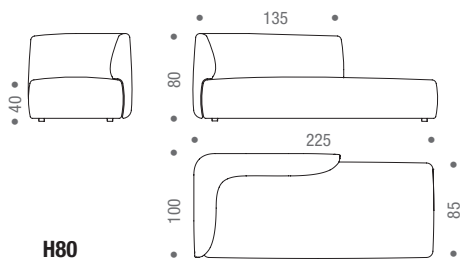
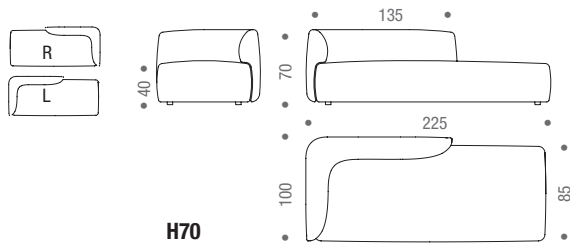
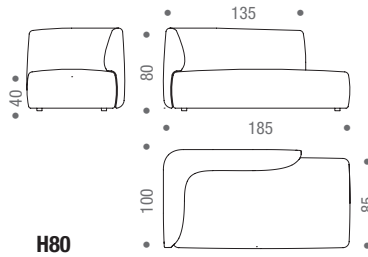
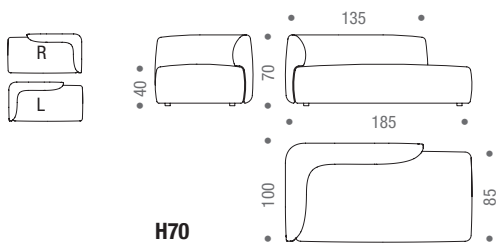

padded modular element XL

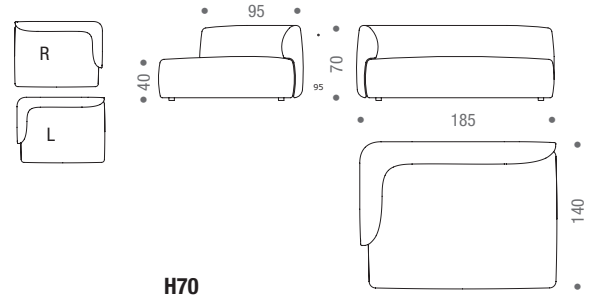
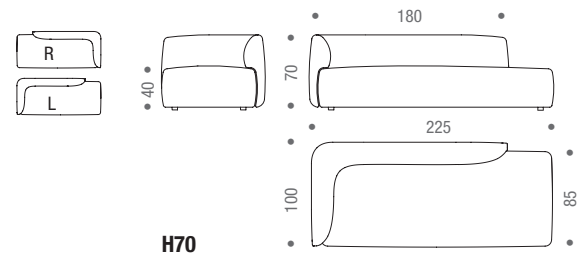
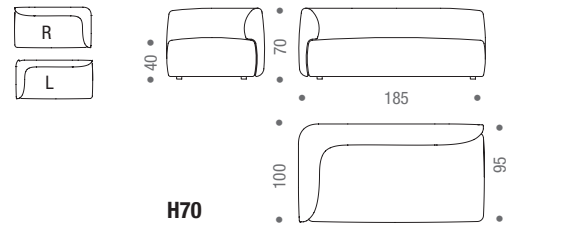

padded corner modular element

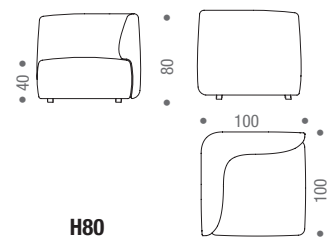
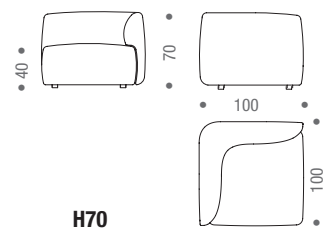

padded intermediate modular element

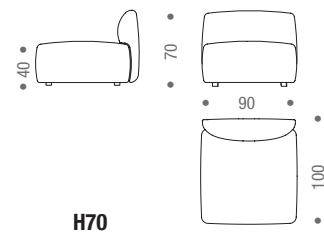

EXAMPLES OF COMPOSITIONS

