

Settings & Preferences

Press and hold the MARK and SENS buttons to access Preferences. To exit Preferences, simply wait a few seconds without pressing a button. The unit will display **Completed** to confirm your selections.

Press MARK to go from one category to the next

Press VOLUME + or - to change your setting within a category

User Mode	Advanced* Novice	Access and customize all Settings and Preferences Access and customize units and display color, (all other Settings are set to factory defaults) <i>NOTE: Switch back to advance mode to view all Preferences.</i>
Pilot	Scan Bar* Full Word	Scanning Bar with Full Word. Full Word: Auto, Auto NoX, AutoLoK or Highway
Display Color	Red*/Amber/Blue/Green	Set color to match your vehicle's dash display
Speed Display	On* Off	Displays current speed Displays battery voltage
Cruise Alert	30 kph* Off / 20-160 kph	Offers double beep alert tones below specified speed
Over Speed	110 kph* Off / 20-160 kph	Reminds you when you exceed a specified speed
Meter Mode	Standard* Spec Expert Simple	Single band with bar graph of signal strength Single band with numeric frequency Multiple bands with bar graph of signal strengths Simple messages replace bands: Caution (if traveling below cruise alert limit) Slow Down (if traveling above cruise alert limit)
Tones	Standard* Mild	Standard ESCORT alert tones Mild doorbell chime alert tones
AutoMute	AutoMute Low / Med* / High / Off	Automatically reduces audio to preferred volume during alert
AutoLearn	On / Off*	Automatically stores and locks out false alarms
Alert Lamp	On*/Band/Off	Turn the Alert Lamp on, off, or select band mode for color-coded alerts. X = green, K = blue, Ka/Laser = red
Units	English / Metric*	Units for distance and speed
Language	English* / Espanol	Language for voice and text
Voice	On* / Off	Voice announcements
GPS Filter	On* / Off	Enables GPS-powered features

AutoPower **Off**

1 Hour
2 Hours
4 Hours*
8 Hours

Power turns on or off depending on your vehicle's ignition type (constant power or switched)
Powers off automatically after 1 hour
Powers off automatically after 2 hours
Powers off automatically after 4 hours
Powers off automatically after 8 hours

NOTE: AutoPower only works with constant power ignition.

NOTE: If AutoPower is on, to save screen life the display screen goes blank after 30 minutes without moving. Display screen will turn on automatically after you reach 10MPH.

Band Enables **Default***
Modified

Default settings for North America
Customize the bands you want to monitor

Press SENS to go from one band category to the next

Press VOLUME + or - to change your setting within a category

X Band	On / Off*	Freq: 24.050-24.250 GHz	
K Band	On*/Off	<i>NOTE: When K Band is off, you can select separate segments of the band to turn on or off.</i>	
KN1	On* / Off	Freq: 24.050 - 24.110 GHz	
KN2	On* / Off	Freq: 24.110 - 24.175 GHz	
KN3	On* / Off	Freq: 24.175 - 24.250 GHz	
KN4	On / Off*	Freq: 23.950 - 24.050 GHz	
Strelka	On / Off*	Strelka detection	
MultaRadar CD	On* / Off	MultaRadar CD detection	
MultaRadar CT	On* / Off	MultaRadar CT detection	
Gatso	On* / Off	Gatso detection	
Ka Band	On* / Off	Freq: 33.400-36.000 GHz	
		<i>NOTE: When Ka Band is off, you can select separate segments of the band to turn on and off.</i>	
KaN1	On / Off*	Freq: 33.392 - 33.704 GHz	KaN6 On / Off* Freq: 34.806 - 35.166 GHz
KaN2	On / Off*	Freq: 33.704 - 33.896 GHz	KaN7 On / Off* Freq: 35.143 - 35.383 GHz
KaN3	On* / Off	Freq: 33.886 - 34.198 GHz	KaN8 On* / Off Freq: 35.378 - 35.618 GHz
KaN4	On* / Off	Freq: 34.184 - 34.592 GHz	KaN9 On / Off* Freq: 35.595 - 35.835 GHz
KaN5	On* / Off	Freq: 34.592 - 34.808 GHz	KaN10 On / Off* Freq: 35.830 - 35.998 GHz
Ka-POP	On / Off*		
Laser	On* / Off		
RDR	On* / Off	Radar Detector Rejection	

Marker Enables **Default*** Default settings
Modified Customize the types of locations you want to mark for future reference

Press SENS to go from one marker category to the next

Press VOLUME + or - to change your setting within a category

Other	On* / Off	Other location
Redlight	On* / Off	Red light camera
Red & Speed	On* / Off	Red light & speed camera
Speed Cam	On* / Off	Speed camera
Speed Trp	On* / Off	Speed trap
Avg Spd Cams	On* / Off	Average speed camera
HOV Lane	On* / Off	HOV lane camera

NOTE: User cannot mark Average speed camera and HOV Lane camera locations.

Clear Locations	Marked	Clear all user Marked locations. Press SENS button to confirm
	Lockouts	Clear all lockouts. Press SENS button to confirm
	Defender	Clear all DEFENDER data. Press SENS button to confirm
	Format	Clear DEFENDER database, all markers, and all lockouts Press SENS button to confirm

***Default Setting**

Notes for Settings & Preferences

For descriptions of features and functions available when connected to ESCORT Live, visit EscortRadar.com and download the RedLine EX Owner's Manual.

To view serial number and software revision press MARK and MUTE while powering on detector.

To restore RedLine EX to its original factory Settings, press and hold MARK and BRT while turning the power on. A "Restored" message will display, acknowledging the reset.

Software Updates

RedLine EX's red light and speed camera DEFENDER database is easily updated using our exclusive detector software tools found on our web site. Firmware, or the operating software for the detector, can also be updated using these tools.

In order to access these updates, you will need to register your RedLine EX at www.EscortRadar.com. To perform the update, connect RedLine EX to your computer using only a USB A / Mini B cable. Do not connect the power cord when updating.

Warranty

ESCORT One Year Limited Warranty

What this warranty covers: Escort, Inc. ("Escort") warrants your Product against all defects in materials and workmanship.

For how long: One (1) year from the date of original purchase from an authorized Escort dealer.

What we will do: If a breach of warranty occurs, Escort, at its discretion, will either repair or replace your Product free of charge.

What we will not do: Escort will not pay shipping charges that you incur for sending your Product to us.

What you must do to maintain this warranty: Show original proof of purchase or receipt from an authorized Escort dealer.

Warranty exclusions: This warranty does not apply to your product under any of the following conditions: 1. The serial number has been removed or modified. 2. Your product has been subjected to misuse or damage (including water damage, physical abuse, and/or improper installation). 3. Your product has been modified in any way. 4. Your receipt or proof-of-purchase is from a nonauthorized dealer or internet auction site, including E-bay, U-bid, or other non-authorized resellers. 5. You are not the original purchaser of the Product from an authorized dealer or did not receive it as a gift from the original purchaser of the Product from an authorized dealer.

To obtain service: 1. Contact ESCORT (1-800-543-1608) to obtain a Return Authorization Number. 2. Properly pack your Product and include: your name, complete return address, written description of the problem with your Product, daytime telephone number, and a copy of the original proof of purchase or receipt. 3. Label the outside of the package clearly with your Return Authorization Number. Ship the Product pre-paid (insured, for your protection) to: ESCORT, Inc., 5440 West Chester Rd., West Chester, OH 45069.

LIMITATION OF WARRANTY: The obligations set forth above are ESCORT's sole obligations and your exclusive remedy. **ESCORT makes no other express warranty. Any implied warranty of merchantability or fitness for a particular purpose that may be applicable to the Product is limited in duration to the duration of this warranty.** Some States do not allow limitations on how long an implied warranty lasts, so the above limitation may not apply to you. **ESCORT SHALL NOT BE LIABLE FOR CONSEQUENTIAL, SPECIAL OR INCIDENTAL DAMAGES INCLUDING, WITHOUT LIMITATION, DAMAGES ARISING OUT OF THE USE, MISUSE OR MOUNTING OF THE PRODUCT.**

Some States do not allow the exclusion or limitation of incidental or consequential damages, so the above limitation or exclusion may not apply to you. ESCORT is not responsible for products lost in shipment between the owner and our service center.

Other legal rights: This warranty gives you specific legal rights, and you may also have other rights which vary from State to State.

Contact Us

Accessories

 **800.433.3487**

 **EscortRadar.com**

Designed in the USA by Escort Inc.,
Manufactured in the Philippines

ESCORT Inc.
5440 West Chester Road
West Chester OH 45069

Sales / Service 800.433.3487
www.EscortRadar.com

©2017 ESCORT Inc. ESCORT®, RedLine EX, Defender®, TrueLock™, AutoSensitivity™, SpecDisplay™, TotalShield™, ExpertMeter™, ESCORT Live™, IVT Filter™ and EZ Mag Mount™ are trademarks of ESCORT, Inc. Designed in the USA by Escort Inc. Manufactured in the Philippines. Features, specifications and prices subject to change without notice.

FCC NOTE: Modifications not expressly approved by the manufacturer could void the user's FCC granted authority to operate the equipment.

FCC ID: QKLXM3. CONTAINS FCC ID: QKLBT2.

This device complies with part 15 of the FCC rules. Operation is subject to the following two conditions: (1) This device may not cause harmful interference, and (2) This device must accept any interference received including interference that may cause undesired operation.

ESCORT Live Compatible



The Bluetooth® word mark and logos are registered trademarks owned by Bluetooth SIG, Inc. and any use of such marks by ESCORT is under license.





ESCORT[®]
REDLINE EX
INTERNATIONAL



Quick Reference

ESCORT® REDLINE EX INTERNATIONAL

Extreme Performance Radar Laser Detector



REDLINE EX
INTERNATIONAL

Stealth Ticket Protection with
Bluetooth® Connectivity



Exclusive Dual Antenna Design
Delivers Extreme Range



GPS Intelligence
Rejects False Alerts



True Stealth Operation Lets
You Drive 100% Undetected



ESCORT Live App Provides
Crowd Sourced Alerts



Congratulations



RedLine EX

You've just purchased the only true stealth radar laser detector with GPS intelligence, extreme range and instant Bluetooth® connectivity to the award-winning ESCORT Live speed trap app.

Go to EscortRadar.com for the full featured RedLine EX Owner's Manual.

Guía de Referencia Rápida Española traducida y manual con todas las funciones también son disponibles a www.EscortRadar.com

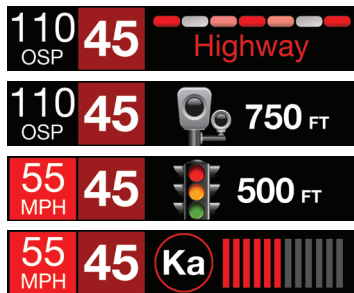

RedLine EX features a new multi-color OLED display. Brilliant graphics illuminate intuitive icons that identify the type of threat at a glance.

RedLine EX Features

- Dual radar antennas provide the longest possible warning in all directions on all radar bands. Multiple high-performance laser sensors provide maximum laser warning and off-axis protection.
- Exclusive TotalShield™ Technology makes the RedLine EX totally undetectable by any radar detector detector (RDD).
- Updatable IVT Filter™ automatically reduces false alerts from moving In-Vehicle Technology sources such as collision avoidance systems and adaptive cruise control.
- GPS location-based intelligence automatically locks out false alerts and allows you to mark locations for future reference.
- Access to ESCORT's DEFENDER Database, which warns you of verified speed traps, speed cameras, and red light cameras.
- Built in **Bluetooth**® technology gives you access to ESCORT's award winning app, ESCORT Live. Our exclusive real-time ticket-protection, the network which warns you of upcoming alerts received and reported by other users in the area, and gives you access to local speed limit data for over-speed alerts.



Live Ready!

EXTREME PERFORMANCE RADAR - LASER DETECTOR

Safety and Care Information

IMPORTANT!

It is your responsibility to ensure that the device is installed in adherence with local laws and regulations and in such a manner as to allow a vehicle to be operated safely and without distraction.

- Do not expose to extreme temperatures above 140°F or below -4°F (above 60°C or below -20°C)
- Do not expose to moisture. Do not use device near or in water. Do not touch the device with wet hands.
- Do not let any foreign matter spill into device.
- Do not expose to chemicals such as benzene and thinners. Do not use liquid or aerosol cleaners. Clean with a soft damp cloth only.
- Do not expose to fire, flame, or other heat sources.
- Do not try to disassemble and/or repair device yourself.
- Do not drop your device or subject it to severe impact.
- Do not place heavy objects on device.
- Do not subject device to excessive pressure.
- Opening the case may result in electric shock.



- Follow local guidelines for waste disposal when discarding packaging and electronic appliances.

FCC Compliance

Modifications not expressly approved by the manufacturer could void the user's FCC granted authority to operate the equipment.

FCC ID: QKLXM3. CONTAINS FCC ID:QKLBT2

This device complies with part 15 of the FCC rules. Operation is subject to the following two conditions: (1) This device may not cause harmful interference, and (2) This device must accept any interference received including interference that may cause undesired operation.

Registration and ESCORT Live

Before downloading ESCORT Live, you must first register your RedLine EX device. Be sure to have your RedLine EX unit nearby, as you will need the serial number.

- 1 Visit www.EscortRadar.com and click Product Registration.
- 2 Click the "Registration for all devices" link.
- 3 Follow the onscreen instructions to register your device.

Be sure to write down the username and password you create, as you will need this information to access and download ESCORT Live. (You will also receive an e-mail with this information, once you have registered your device.)

For iPhone:

- 1 Ensure RedLine EX power is ON
- 2 Open the App Store on your iPhone and search for **ESCORT Live Radar**. 
- 3 Follow the onscreen instructions to download **ESCORT Live Radar** and then open the app.
- 4 When prompted, enter the username and password you created when registering your product at EscortRadar.com.
- 5 Press the Settings button  then select **Devices**.
- 6 You should see **RedLine EX** listed with Not Connected underneath. Press the **RedLine EX** device entry and when prompted select Pair.
- 7 The Bluetooth icon on the RedLine EX display will appear to confirm that it is paired to your iPhone.

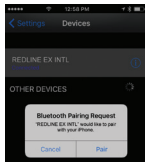

For Android based smartphones:

- 1 Ensure RedLine EX power is ON.
- 2 On your smartphone go to Bluetooth® Settings and make sure that Bluetooth® is ON.
- 3 Press Scan for devices and wait for the device list to populate, **RedLine EX** should appear under Available devices.
- 4 Press the **RedLine EX** device entry.
- 5 The Bluetooth icon on the RedLine EX display will appear to confirm that it is paired to your smartphone.
- 6 Open Google Play on your smartphone and search for **Escort Live Radar**. 
- 7 Follow the onscreen instructions to download **Escort Live Radar** and then open the app.
- 8 When prompted, enter the username and password you created when registering your product at EscortRadar.com.
- 7 Open the app, walk through the tutorial, and you're ready to hit the road!

Installation

Your new detector comes with our latest **EZ Mag Mount™**. Simply tilt the display end of the detector up and slide it onto the mounting bracket. The magnetic mount holds the detector in place. To remove the detector from the mount, simply lift the display end of the detector and the detector releases from the mount.

Mounting Tips:

- Center of windshield between driver and passenger.
- Ensure clear view of road ahead and sky above.
- Avoid windshield wipers and heavily tinted areas.

To mount the detector in your vehicle:

- 1** Remove paper backing from EZ Mag Mount™ StickyCup.
- 2** Ensure the locking clamp is open.

- 3** Firmly press EZ Mag Mount™ StickyCup onto windshield and close the locking clamp to secure.
- 4** To adjust view, loosen thumb wheel and adjust angle of mounting bracket. Tighten thumb wheel to secure.
- 5** Tilt the display end of the detector slightly upward and engage with the flanged edge of the mounting bracket. The EZ Mag Mount™ magnet holds the detector in place.
- 6** To remove the detector, simply lift the display end of the detector upward. The RedLine EX will release from the mount.
- 7** To remove mount from windshield, release locking clamp and pull tab on top of StickyCup.

EZ Mag Mount™ Care Instructions:

Should the EZ Mag Mount™ StickyCup accumulate debris and lose its stickiness, simply rinse under warm water, gently wipe off debris and allow to air dry.

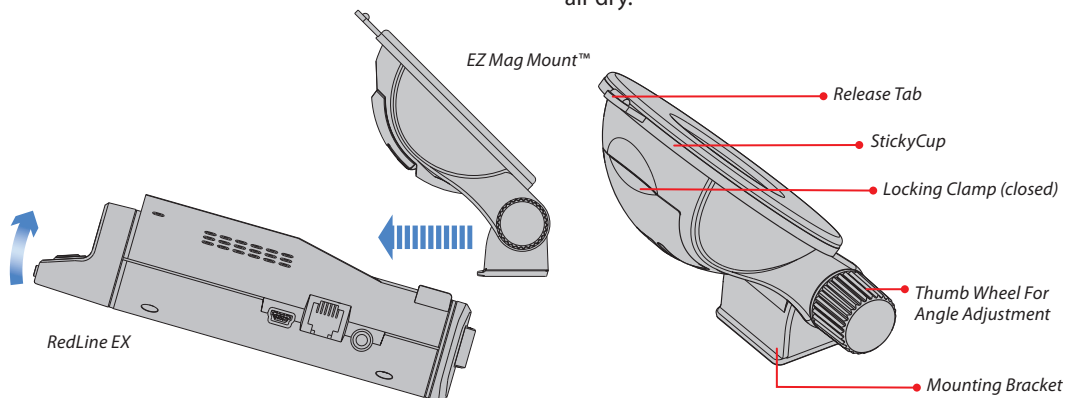

5

Controls & Features

Using RedLine EX

- 1 Plug small end of SmartCord USB into modular jack on RedLine EX and large end of SmartCord USB into your car's lighter/accessory socket.
- 2 RedLine EX should power on automatically. If not, press the device's PWR button.

Power requirement

11.0-16.0 Volts DC negative ground
400mA standby, 700 mA maximum

NOTE: You can easily access and customize all of your Settings and Preferences by pressing and holding the MARK and SENS buttons. See Settings & Preferences for details.

Earphone Jack

Connects to optional 3.5 mm stereo earphone

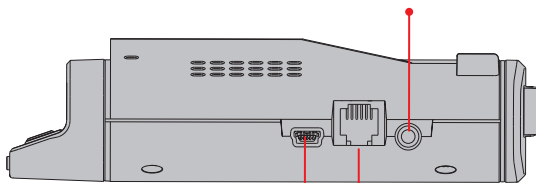

Mini USB Jack

Connects to your computer via USB A / Mini B cable for downloading software updates

Modular Jack

Connects to SmartCord USB for powering your device

Using SmartCord USB

- **Mute Button:**
 - Press to mute the audio for a specific alert.
 - Press three times to lock out a false alert.
 - Press twice while receiving a locked-out alert to unlock.
 - When connected to ESCORT Live press and hold mute button on unit or cord to manually report to other users a verified X or K-band alert, or a police officer observing traffic.
- **Alert Light:** Blinks red when receiving a radar or laser alert.
- **Power Light:** Lights green when receiving power.
- **USB Charging Port:** Charge smartphones, tablets and other USB-charged Devices.



Modular Connector

Plugs into detector jack

SmartCord USB Adapter

Connects to lighter/accessory socket

Controls & Features

Mute

Press to mute an alert; press three times to lock out a false alert; press twice while receiving a locked-out alert to unlock

Display

Current speed

Mount Area

The EZ Mag Mount™ attaches to device here

Display

Alert area

Volume

Press and hold + or - to adjust volume

Sensitivity (SENS)

Press to adjust detector sensitivity (Auto, AutoNoX, AutoLoK, and Highway)

Mark Location (MARK)

To mark a location for future alerts, press MARK twice, then VOL + or - to select the type of marker, then MARK again to confirm. Press twice while receiving marker alert to unmark

Brightness (BRT)

Press to adjust display brightness (Min, Med, Max, Auto, Dark)

PWR

Press to turn RedLine EX on or off

Display (OSP)

OverSpeed alert setting that can be adjusted in Preferences. **Bluetooth** icon will appear on display screen blue when paired to phone and Speed limit data will show here when ESCORT Live App is open.

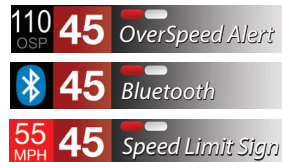
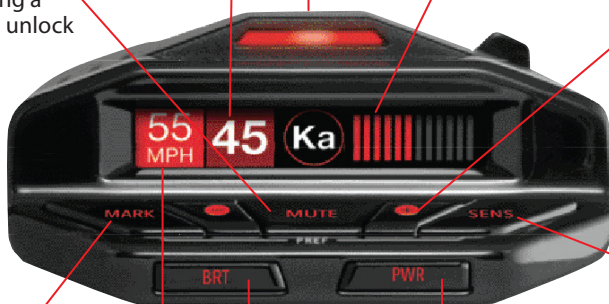

Continued →