



# EDGE FREE® CineWhite® UHD-B Series

*Matte White Fixed Frame Screen*

**USER'S GUIDE – M Type**

V1

---

## **Product Description:**







The **EDGE FREE® CineWhite® UHD-B Series** is a fixed frame projection screen that uses Akia's EDGE FREE® technology. The EDGE FREE® design resembles a flat panel TV display. The **EDGE FREE® CineWhite®** includes a micro-thin bezel trim to further enhance the frame appearance and absorb projector overshoot.

The screen material included is our **ISF certified CineWhite® UHD-B**, which is a reference quality front projection material with black backing that is certified by the world-renowned Imaging Science Foundation. ISF Certified means the CineWhite UHD-B material produces accurate colors in a light-controlled dark room environment. This is an industry standard for high-fidelity video display systems. ***Watch your content as the director intended!***

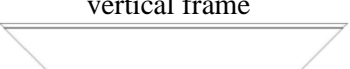
In order for the **CineWhite® UHD-B** to maintain its projection qualities and optimum performance, please refer to the list below for proper maintenance and cleaning.







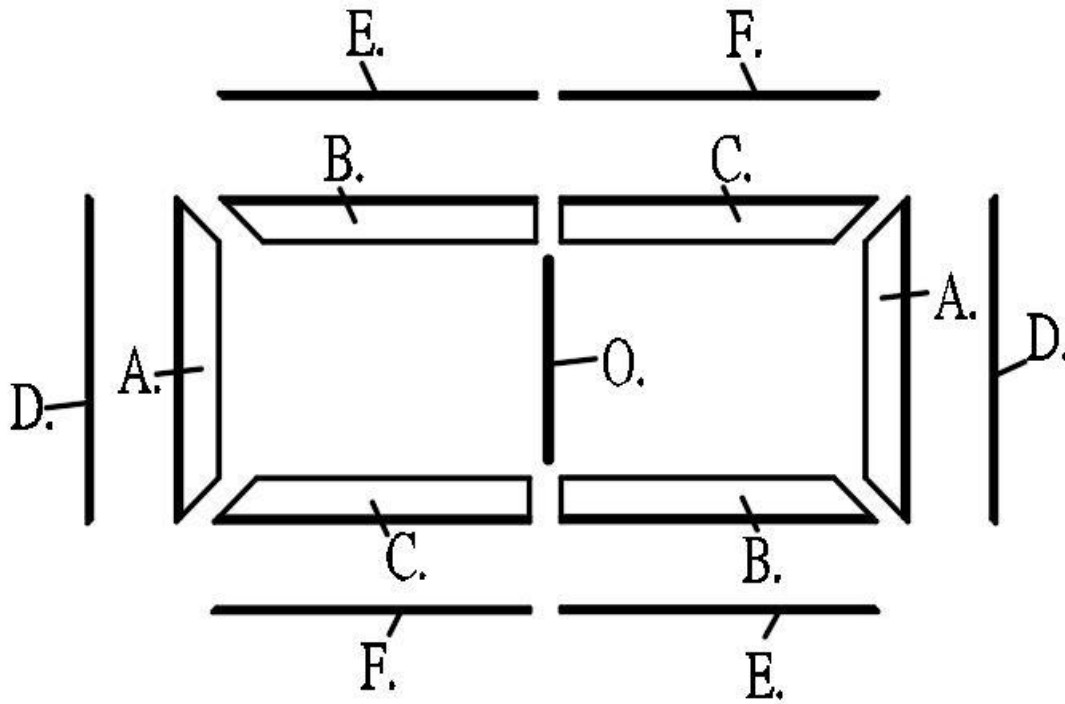



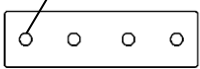
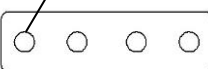
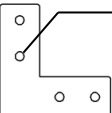
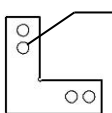
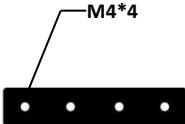



- Use a dry microfiber cloth to remove dust from the screen's surface.
- When cleaning, use a damp microfiber cloth with warm water to remove any marks.
- Never rub or apply pressure when cleaning the surface.
- Never attempt to use any solutions, chemicals or abrasive cleaners on the screen surface.
- In order to avoid damaging the screen, avoid touching it directly with your fingers, pens/pencils or any other sharp or abrasive objects.

**1. Frame and Edge Trim Parts List**

Qty item	2 pcs Main Frame Parts	Qty item	2 pcs Edge Trim Parts
Part A.	vertical frame 	Part D.	
Part B.	½ horizontal frame 	Part E.	
Part C.	½ horizontal frame 	Part F.	



**2. Hardware Parts List**

a.  M4*4	b.  D5*4	c.  M4*4	d.  D5*4
e.  M4*4	f.  M4*4	g. 	h. 
i. 	j. 	k. 	l. 
m. 	n. 	o. 	p. 
q. 	r.  Red Black		

Item	Parts List	100"	125"	145"
a.	Center Joints- M4 (bottom position)	2	2	2
b.	Center Joints-D5 (top position)	2	2	2
c.	Elbow Joints M4 (bottom position)	4	4	4
d.	Elbow Joints D5 (top position)	4	4	4
e.	Side cover Center Joints- M4	2	2	2
f.	Side cover Elbow Joints M4	4	4	4
g.	M4x7 Screws	24	24	24
h.	Spring	56	72	84
i.	Spring Hook	2	2	2
j.	wall brackets	4	4	4
k.	Φ5x50 Wall Screws	8	8	8
l.	Hollow Wall anchors	8	8	8
m.	M4x4 Screws	24	24	24
n.	Angle cover	4	4	4
o.	Center Support Bar	1	1	1
p.	White gloves	2	2	2
q.	Spring	4	4	4
r.	Φ3 mm Long Iron (sides) rod / Short rod (top/bottom)	2/4	2/4	2/4

## Frame Assembly

**Step 1:** Place the included soft padded EPE sponge sheet on a clean area where the screen will be assembled.

**Step 2:** Position the pieces of the frame on the EPE sponge in the arrangement shown below

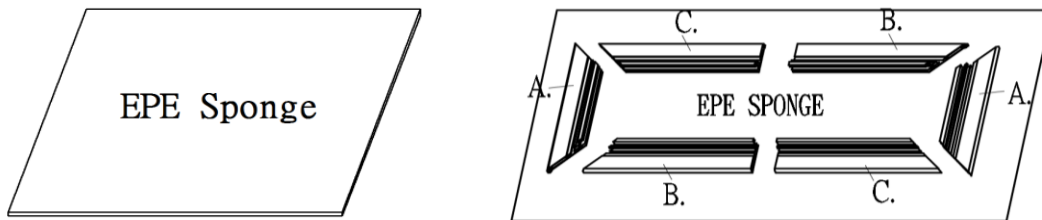

**Step 3:** Insert *center joint (a/b)* connectors into *one-half of the horizontal frame (B/C)* and secure with the *M4x7 screws (M)* as shown in the illustration below.

**Tip:** The center joint (b) with the larger diameter holes should be on top.

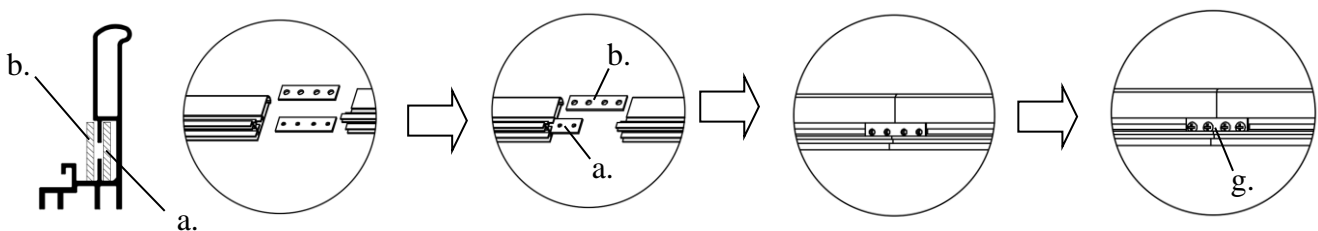

**Step 4:** Connect the *elbow joints (c/d)* to the top and bottom sections of the vertical frame. Once inserted, connect the vertical sections to the horizontal frame sections. Make sure all holes are in alignment and the frame pieces are flush (no gaps). They should form perfect right angles.

**Tip:** The elbow joint (d) with the larger diameter holes should be on top.

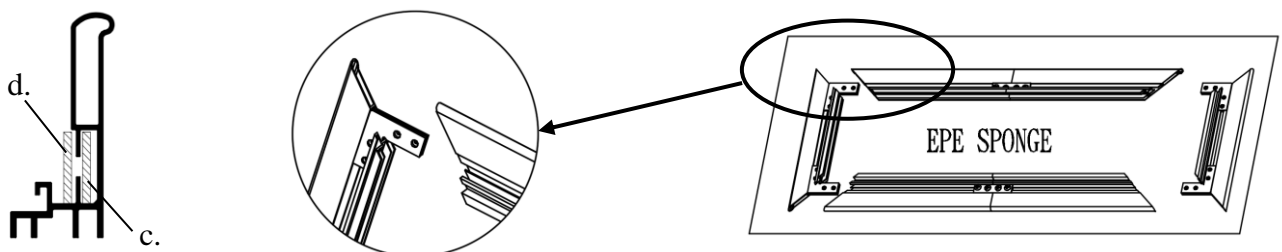

**Step 5:** Secure the elbow joints by fastening them with **M4x7 screws (g)**, 4 at each corner.

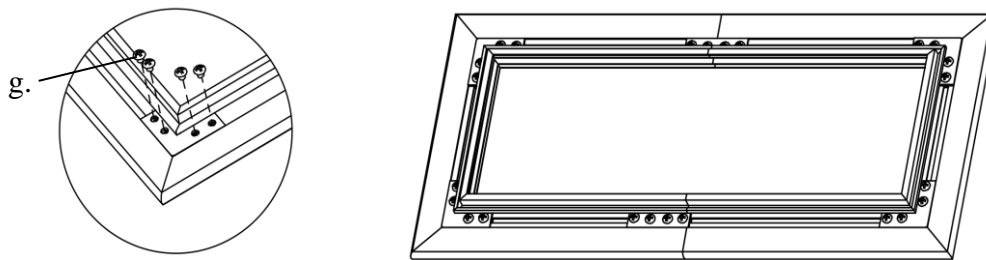

## Screen Material

**Step 6:** Put on the **white gloves (p)** and carefully unroll the screen material on a clean surface from the roller to the other side as shown below. The back side of the screen material should be placed upwards.

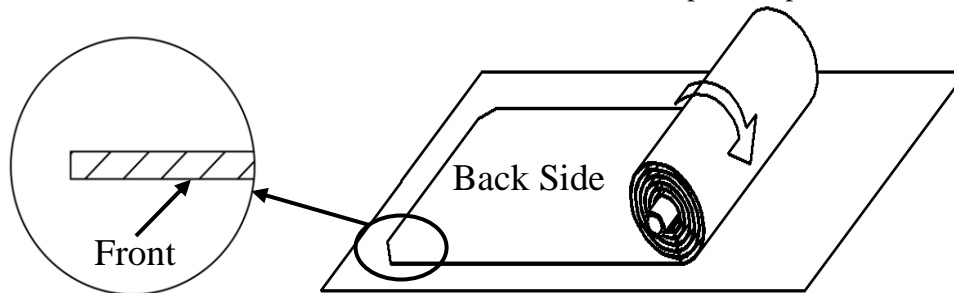

**Step 7:** Insert the **rods (r)** through the sleeves according to their corresponding lengths on each edge of the screen as shown below. The short rods (top/bottom) will overlap to secure a firm grasp in the middle areas.

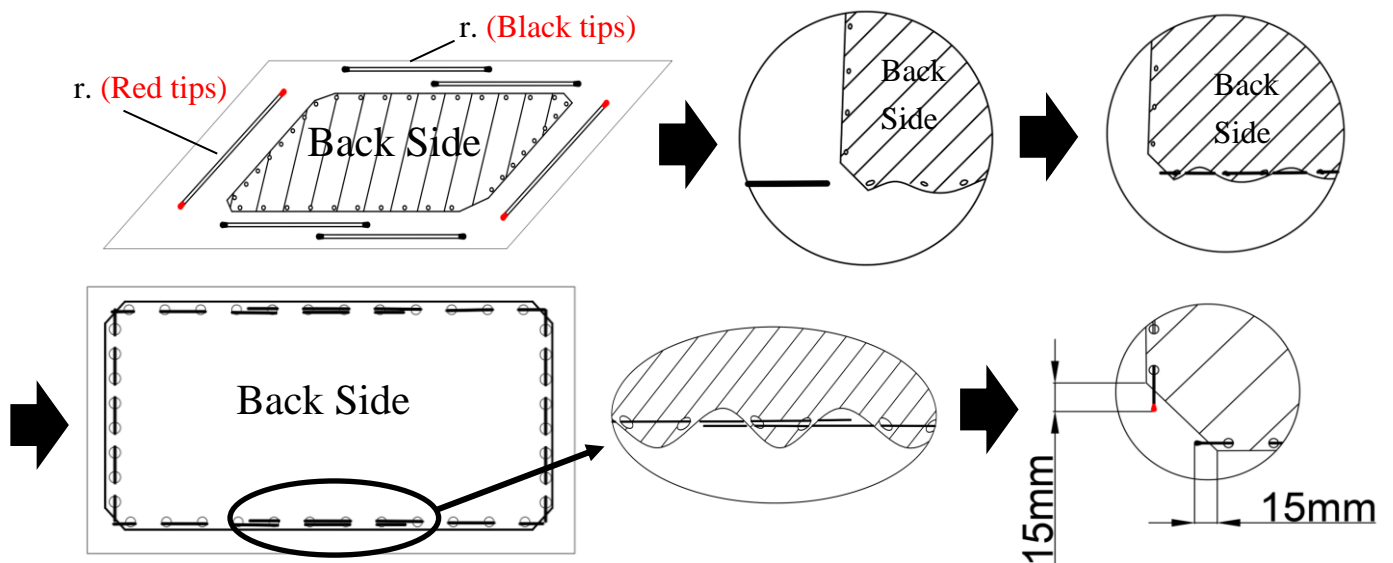

**Step 8:** Carefully and gently place the assembled frame on top of the screen material in the marked areas as shown below. Make sure to not allow the angle edge of the frame to come in direct contact with the screen material to avoid puncturing it.

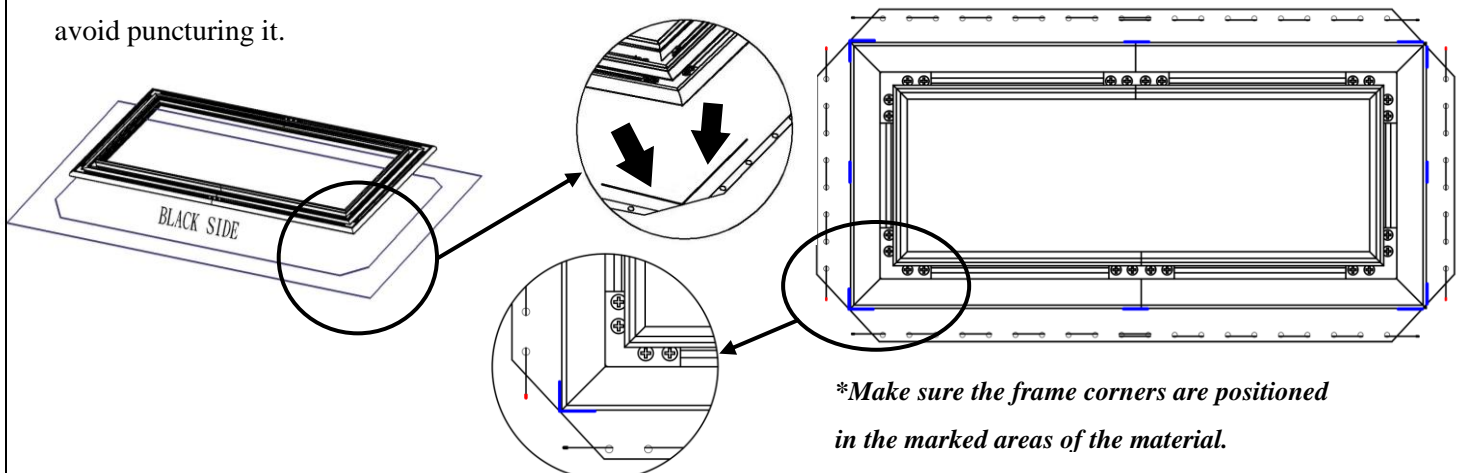

## Center Support Bar

**Step9:** Insert the *Center Support Bar (o)* into the upper top groove on the back of the frame with the bottom end near the approximate center point of the frame and rotate it in at an angle so that both ends of the bar are in alignment with the groove.

**Diagonal Sizes of 150" and below use 1 x Center Support Bar**

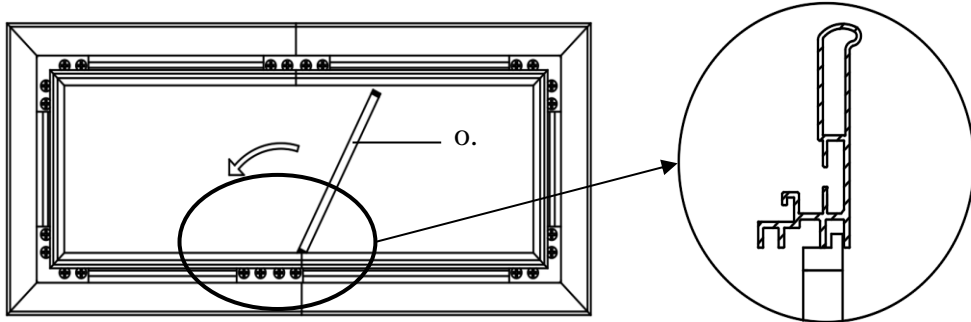

**Step 10:** Hook one end of the spring and secure inside the groove of the frame, use the *spring hook (h)* to attach the spring to the hole located on the screen material's outer edge in the following order.

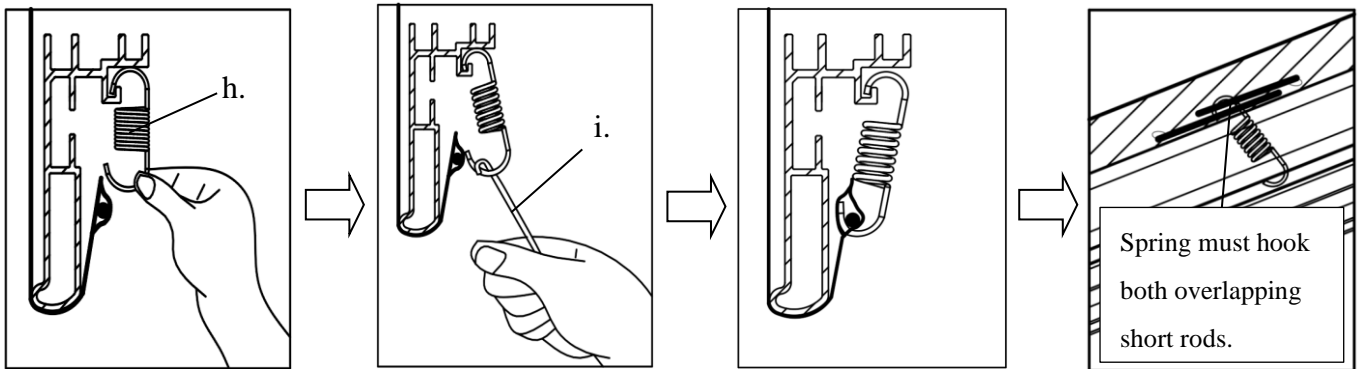

Begin by first attaching the center points on both vertical (left/right) sides, *steps 1-2*. Then the center points on both horizontal (top/bottom) sides, *steps 3-4*. Once all center points have been secured, make sure the screen material is still within the marked areas before proceeding to attach the next springs.

Continue attaching the rest of the springs to the material in the following order in *steps 5-12*.

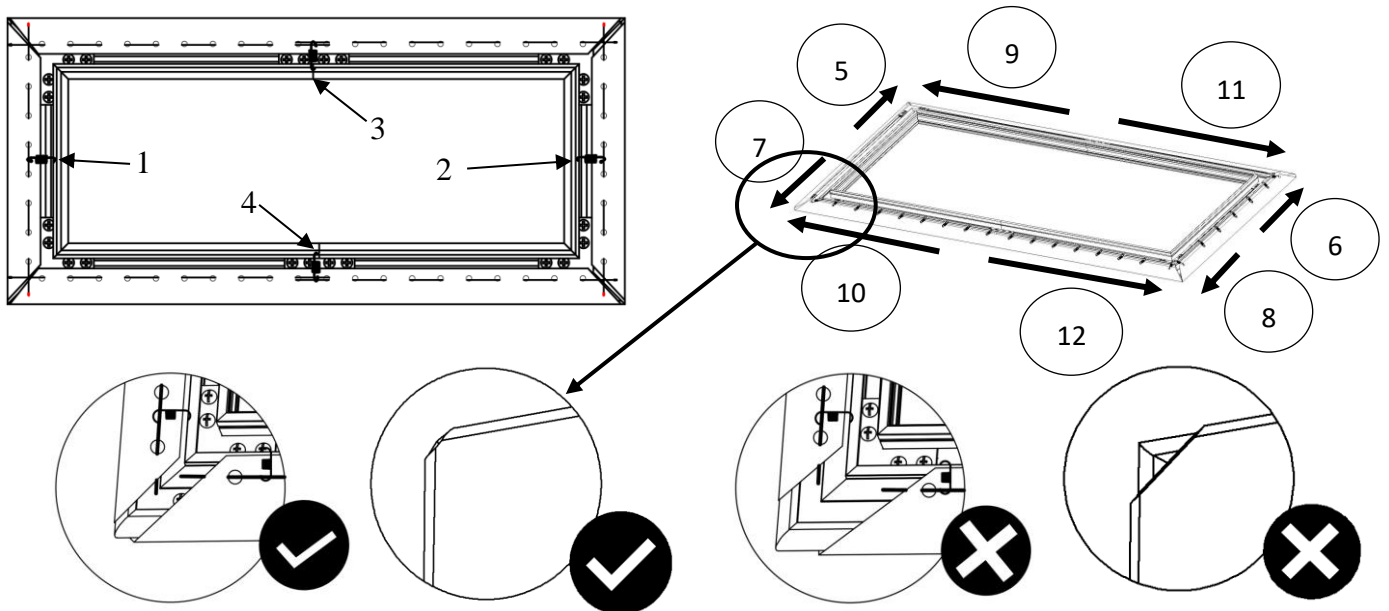

To avoid ripples forming in the material it is imperative that all of the corners are properly wrapped around the edges as illustrated in the check mark diagrams.

**Note (after all springs have been attached):**

**Correct material installation** –Corners of the screen material are properly wrapped around the corner edges of the frame and material is evenly tensioned and flat, creating a nicely taut surface.

**Incorrect material installation** –The corners of the screen material are not properly wrapped along the edge of the frame leaving the material with unbalanced tension and an uneven finish. To correct, detach springs from material at the corner(s) where material does not lie flat along the edge of the frame, reposition the material so that it lies flat and wraps along the edge of the frame, and reattach springs to the material.

### **How to avoid getting ripples on the screen's material surface**

**Solution:** Pull and smooth out the material using your hand from the center to the corners, creating a nicely taut surface as shown below.

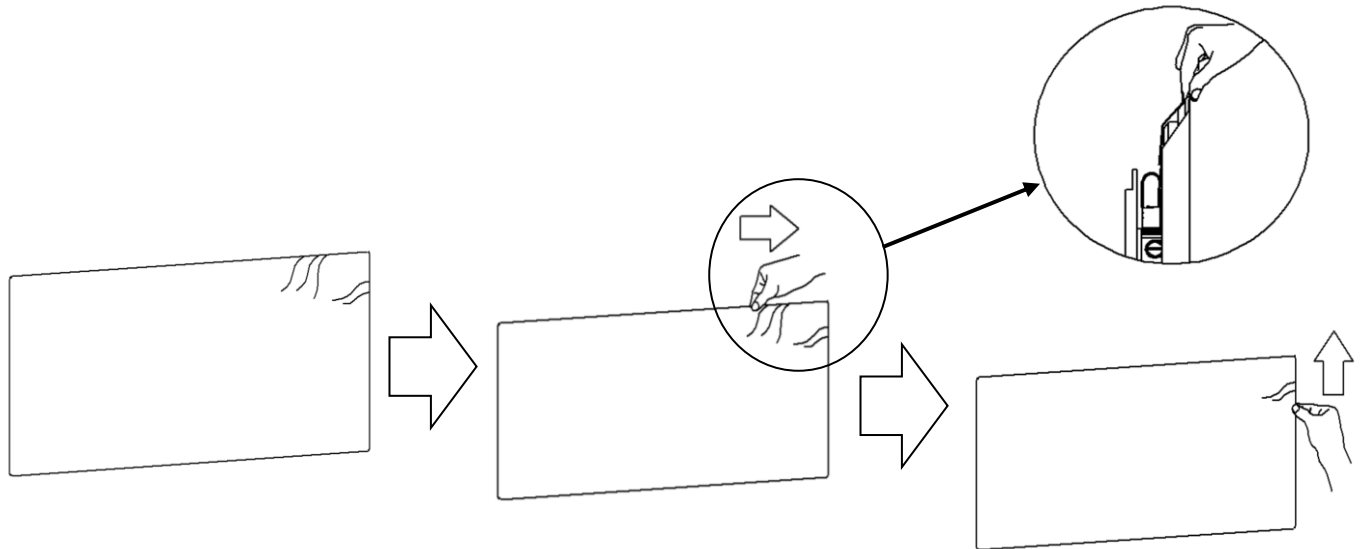

### **Edge Trim Installation**

**ATTENTION: THE TOP EDGE TRIM PIECE WITH THE LOGO SHOULD BE INSTALLED ON THE TOP.**

**Step 11:** Place the edge trim frame pieces over each end of the frame.

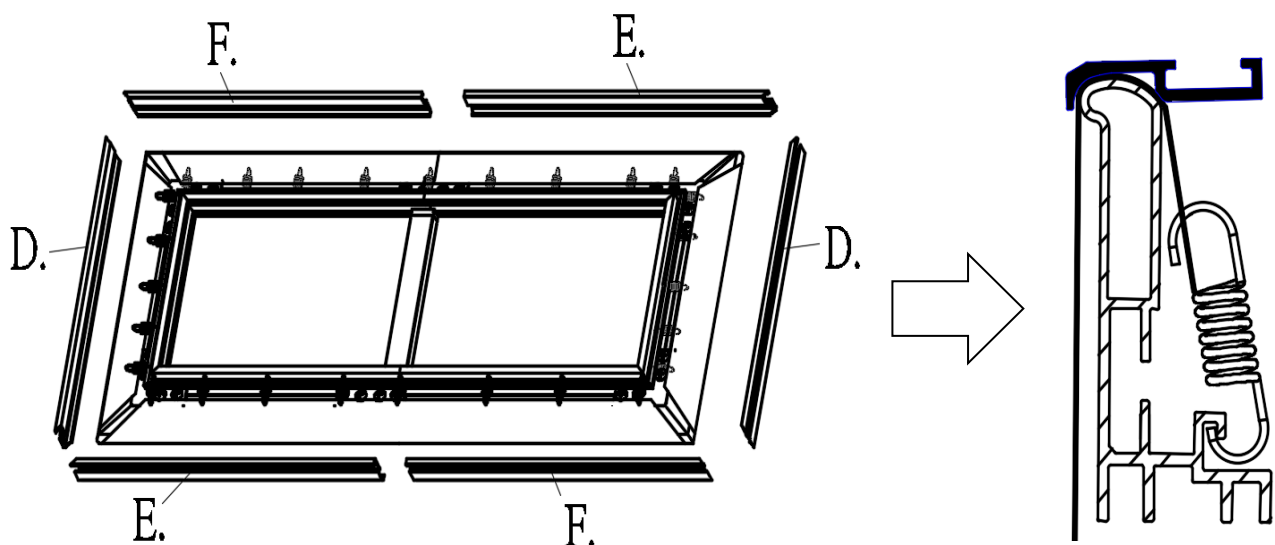

Connect edge trim frames (*e/f*) together using the *M4 center joint (e)* and secure with four of the *M4x4 screws (m)* as show in *Step 1*. Repeat for other side.

Once both top and bottom edge trim frames have been connected, attach the vertical (left/right) sides edge trim frames (*d*) using the *elbow joints (f)* and secure with four *M4x4 screws (m)* on all corners, *Step 2*.

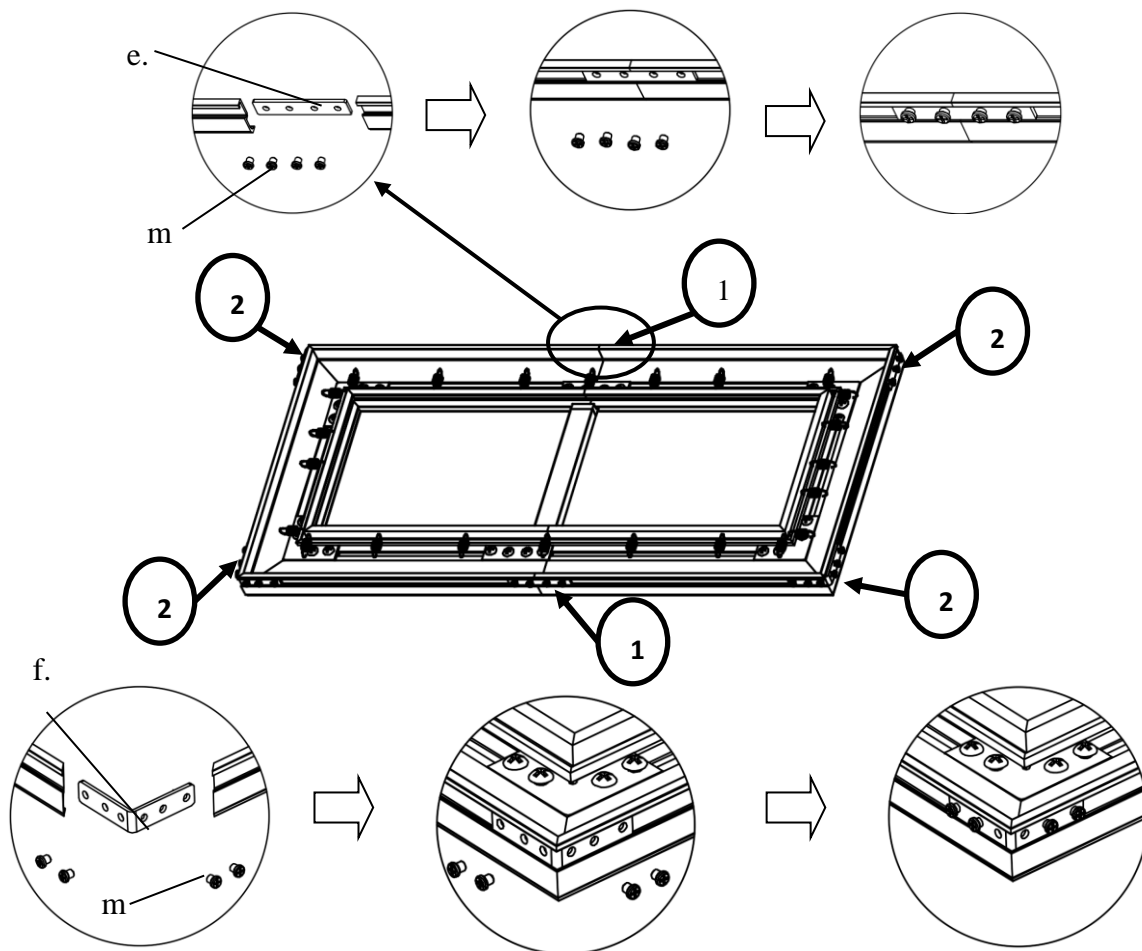

**Step 12:** Install the *angle cover (n)* on each corner of the frame using the *M4x4 screws (m)*.

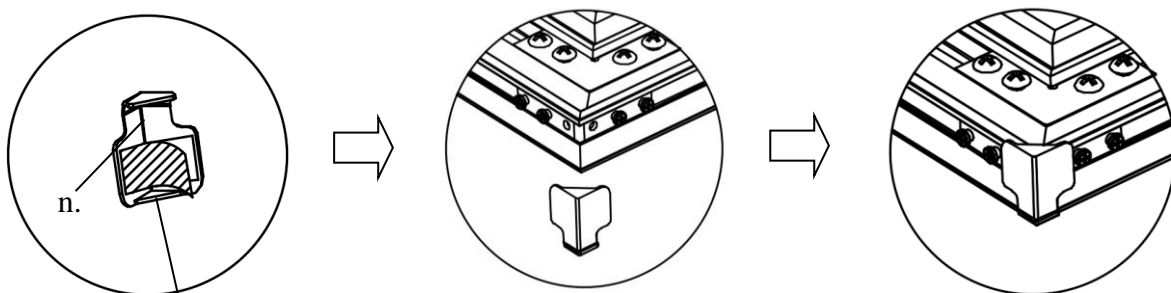

Tear off the double-sided tape.

**Step 13:** Install the *springs (q)* in each middle area to further support the bezel trim edge frame.

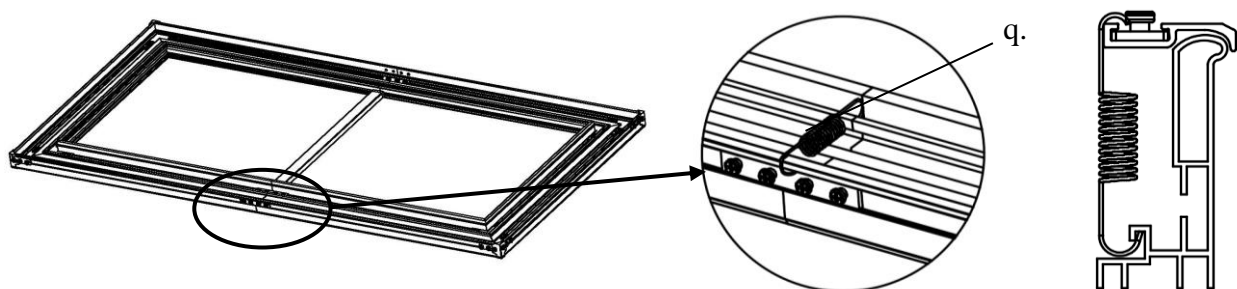

## Wall Installation

**Step 14:** Measure the overall length and height of the frame and drill holes for the top brackets. Line up the wall brackets with the drilled holes on the installation location and screw them in using a Phillips screwdriver. If not installing into a structural wood stud, use a hollow wall anchor then screw in the M5x50 wood screws with a screwdriver. Make sure the brackets are leveled.

### **Diagonal Sizes of 150" and below use 4 x wall brackets**

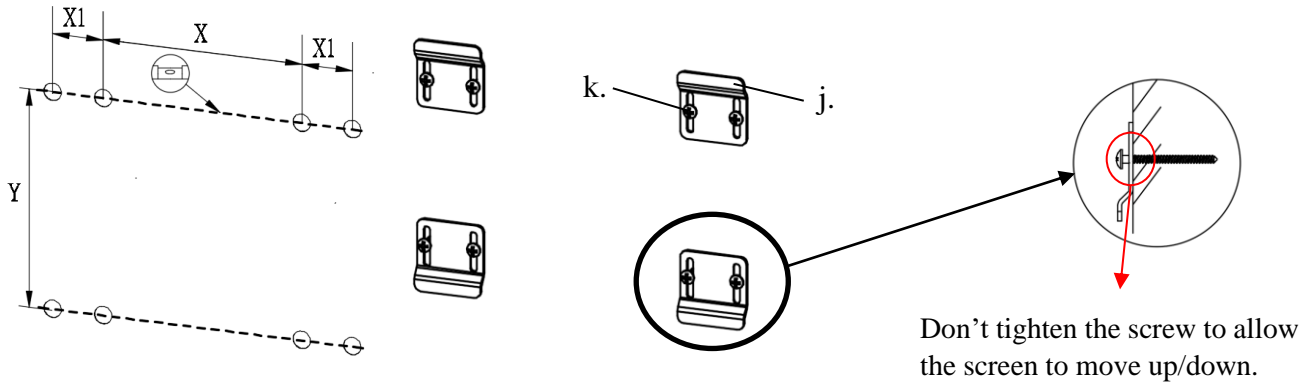

Model/Size	X = Wall bracket distance	X1 = Bracket hole distance	Y = Top/Bottom Wall Bracket Height
100"	1200mm (47.24")	30mm (1.18")	1080mm (42.52")
125"	1400mm (55.12")	30mm (1.18")	1400mm (55.12")
145"	1400mm (55.12")	30mm (1.18")	1640mm(64.57")

**Step 15:** Begin by placing the frame on the bottom bracket, move up and position onto the top wall brackets as shown below and push down at the center of the top of the frame to secure.

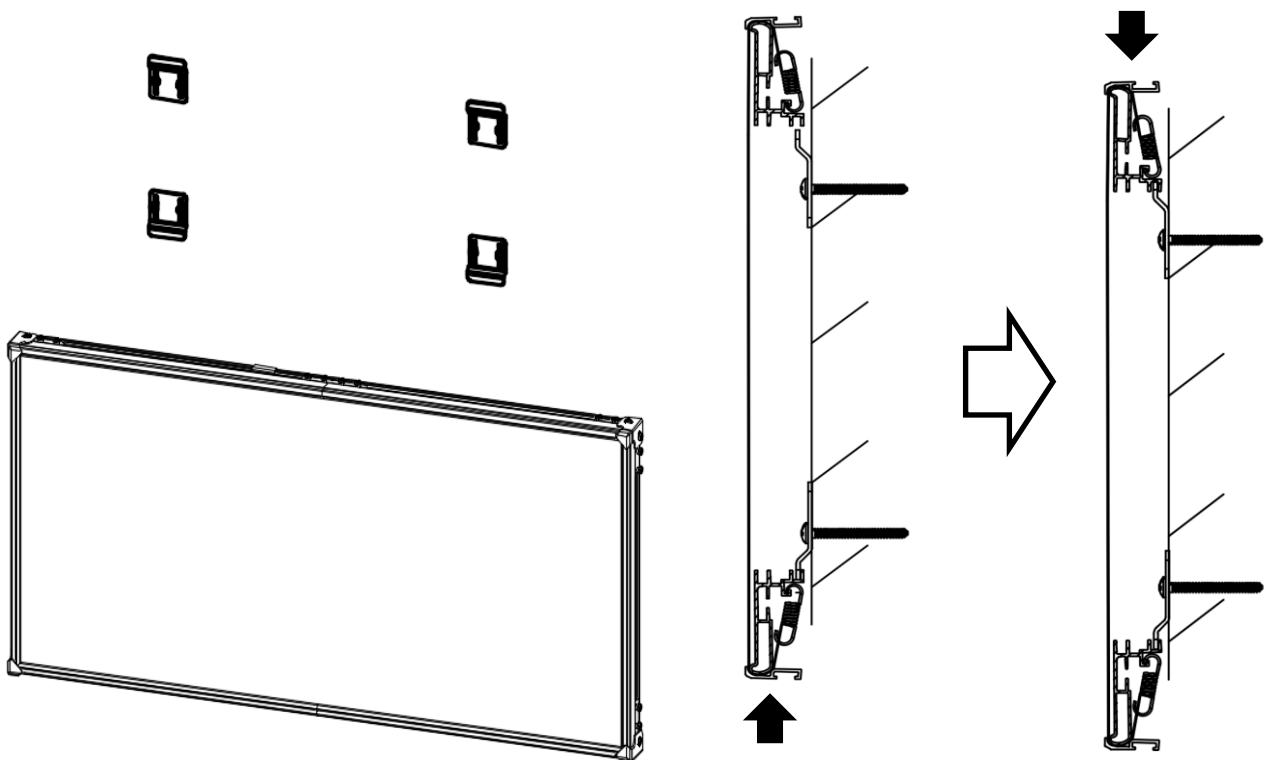

**For Technical Support or an Akia Screens contact in your area, visit**

**[www.akiascreens.com](http://www.akiascreens.com)**