

Fixed Frame screen series

Fixed Frame Projection Screen

User's Guide – EN type











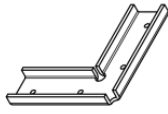

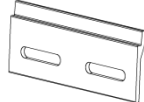

Thank you for choosing an AKIA fixed frame projection screen! Please read through this user guide before utilizing the screen. Correct usage and maintenance will ensure a long product life.

Care & Use Instructions

Dust, dirt and scratches on the projection surface will affect the picture quality, please take note of the points below to prevent that from occurring:

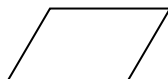
1. Do not touch the projection surface with your hands
2. Do not write or draw on the projection surface
3. Do not use fingers or sharp objects to point on the projection surface; this will damage the screen material.
4. Use a soft-damp cloth to clean the projection surface; do not use chemical cleaning agents or alcohol.
5. Use clean water when dampening the cleaning cloth and do not rub against the material to clean it.

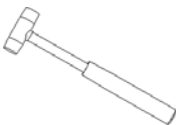
Hardware and Parts List

Hardware and Parts List			
a: Frame parts x 6 pcs (Springs pre-installed)	b: Elbow Joints x 4 pcs	c: M5*6 screws x 24 pcs	d: Springs hook x 2 pcs
			
e: Tension rods x 6 pcs	f: M4*32 wood screws x 8 pcs	g: Ø13*40 Anchors x 8 pcs	h: Wall brackets x 4 pcs
			
i: Center support bar x 1 pc	j: Gloves x 2 pair	k: Protection sheet x 1 pc	l: Screen Material x 1pc
			
m: Center joints x 2 pcs	n: Rubber hammer x 1 pc	o: Screwdriver x 1 pc	p: Ø12*Ø4*1 Washers x 8 pcs
			

Note: Please make sure all parts are included in your package before proceeding to assemble the fixed frame screen.

Frame Assembly

1. Please wear **gloves (j)** before installation.
2. Insert the **center joint (m)** connector into to one of the 1/2 horizontal frames and fasten it with two **M5*6 screws (c)**. Repeat steps for assembling the second horizontal frame.

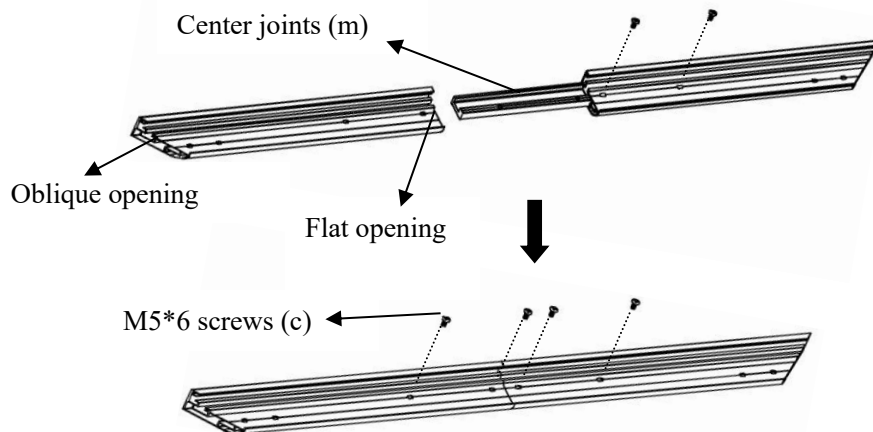

Note: a. Two 1/2 horizontal long frames should be assembled for a screen.

b. Do not tighten the screws completely until all frame pieces have been assembled correctly.

3. Insert both **Elbow Joints (b)** connectors into the slot of short vertical frame and fasten it with four **M5*6 screws (c)** (Fig.1.1).

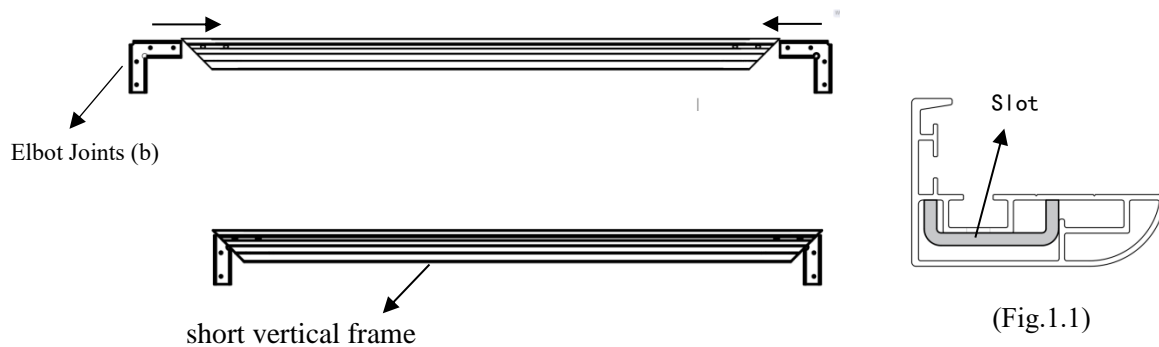

4. Insert the long frame into the exposed **Elbow Joints (b)** connectors and fasten them with **M5*6 screws (c)** (Fig.1.2).

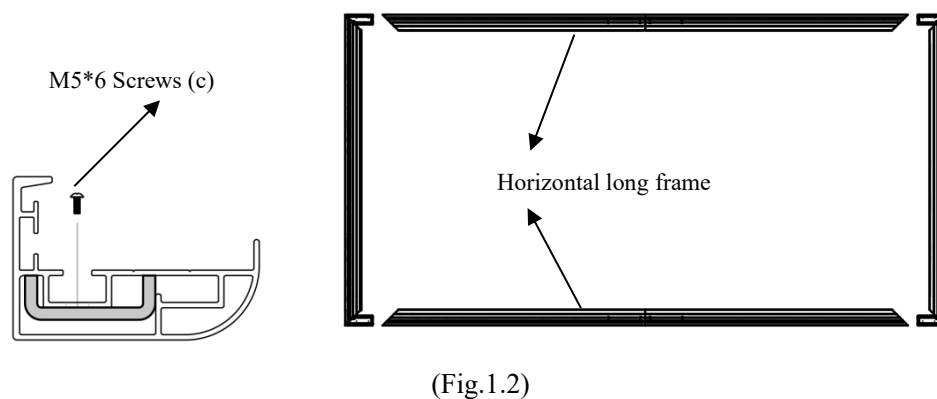

5. Join all four frame parts together following the steps shown below. (Fig.1.3)

Note: When assembled, please push simultaneously the two ends of the long frames.

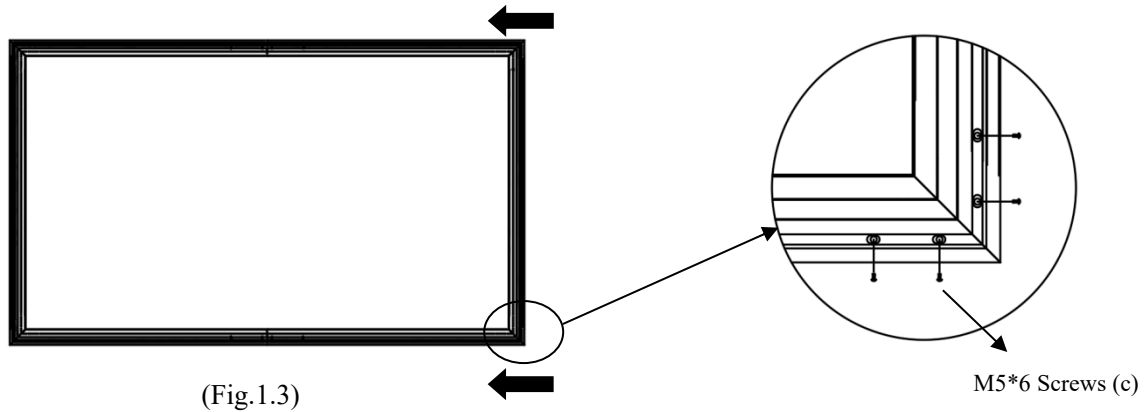

Attaching the screen material to the frame

1. Unroll the screen material and lay it down on a clean **protection sheet (k)** (Screen material facing down). Then Please place the frame gently on the screen material.
2. Insert the **tension rods (e)** separately into the edges of all four corners of the material.

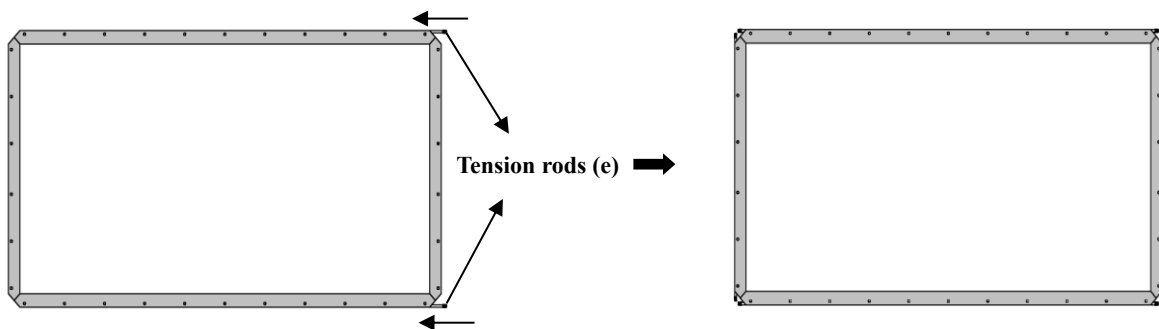
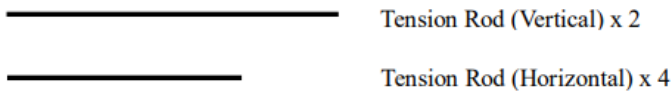

3. Distribute and place spring in the frame one by one corresponding to the holes, (spring has pre-installed in the frame.)
4. Use **spring hook (d)** to install screen material, please install four springs at the four corners of the frame in ABCD order:

Note: Hold the tension rod in the screen material with left hand, hook the spring with right hand, and finally use the spring hook onto the tension rod in the screen material hole, as shown as below.

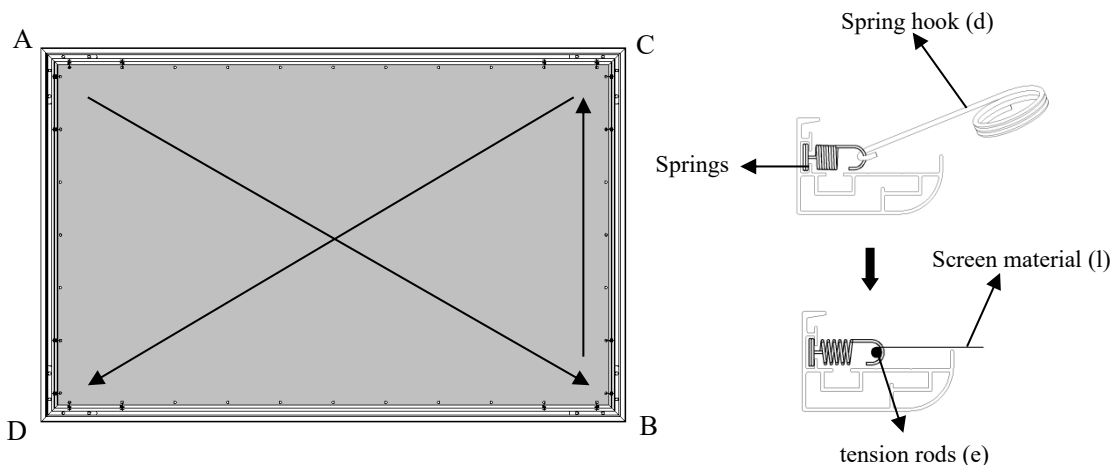

5. Install all the spring on screen material, install the spring at position 1, then continue to install the spring at position 2, then finally install the rest of spring on the screen material, shown as below.

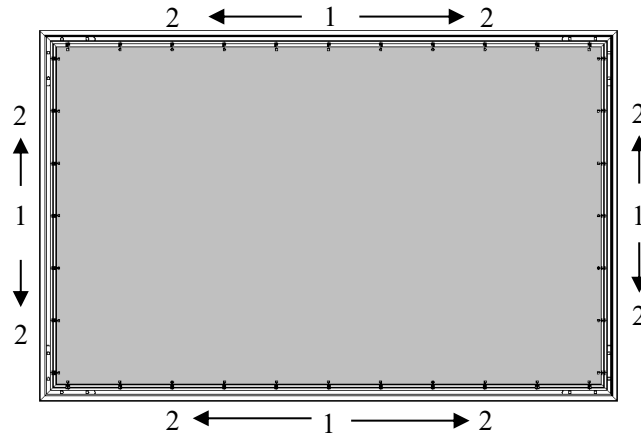

Center Support Bar

1. Insert the **Center Support Bar (i)** into the upper top groove on the back of the frame with the bottom end near the approximate center point of the frame and rotate it in at an angle so that both ends of the bar are in alignment with the groove, shown as below.

2. Slide the top end of the bar into the top center point of the frame to complete the center support bar installation.

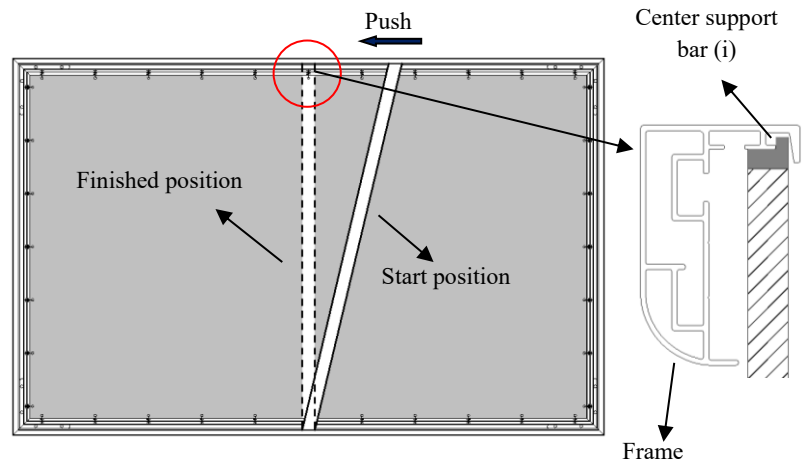

This will provide added stability to your frame and added tension to the material.

Installation

1. Locate your desired installation location with a stud finder (recommended) and mark the drill-hole area of where the screen is to be installed. Reference the table below for

Unit: mm (inch)	92"	100"	110"	120"	135"	150"
L = Wall bracket distance	1500 (59.1")	1500 (59.1")	1800 (70.9")	2000 (78.7")	2000 (78.7")	2500 (98.4")
H = Top/Bottom Wall Bracket Height distance	1195 (47.0")	1294 (50.9")	1419 (55.9")	1543 (60.7")	1729 (68.1")	1917 (75.5")

2. Drill a hole with the proper bit size according to the **Ø13*40 Anchors (g)** and **M4*32 Wall Screw (f)** included.
3. Line up the **wall brackets (h)** with the drilled holes on the installation location and screw them in using a screwdriver.

4. Position the fixed frame screen onto the top wall brackets as shown as below info and pull down at the center of the bottom frame to secure the installation.

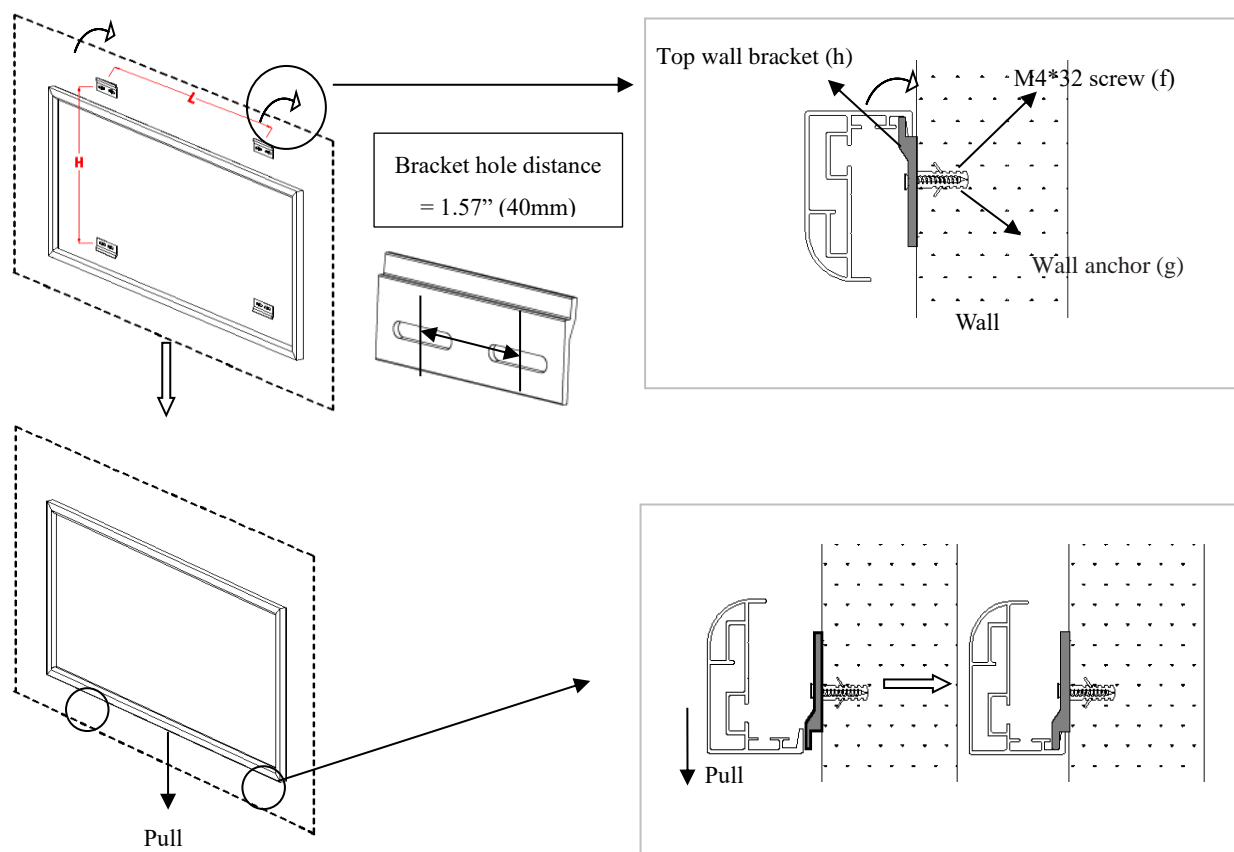

5. The design of the wall brackets allows the frame to slide over them through its sides. This is an important feature of the installation design as it allows your screen to be properly centered.
6. Using both hands finish the installation by pulling the lower portion of the fixed frame screen into the lower bracket as shown as below info.

Caution

Please follow these instructions carefully to ensure proper maintenance and safety of your Fixed Frame Screen.

1. When hanging the screen up, please make sure that no other objects such as power switches, outlets, furniture, ladders, windows, etc. occupy the space designated for your Fixed-Frame screen.
2. Regardless if the screen is hung on or installed into the wall, make sure that the proper mounting anchors are used and that the weight is supported appropriately by a strong and structurally sound surface just as any large and heavy picture frame should.

(Please consult a home improvement specialist for the best advice on installation)

3. Frame parts are made of high-quality velour-surfaced aluminum and should be handled with care.
4. When not in use, cover over the screen with a furniture sheet to protect it from dirt, grime, paint or any other impurities.
5. When cleaning, use a damp soft cloth with warm water to remove any marks on the frame or screen surface.
6. Never attempt to use any solutions, chemicals or abrasive cleaners on the screen surface.
7. In order to avoid damaging the screen, avoid touching it directly with your fingers, tools or any other sharp or abrasive objects.
8. Spare Parts should be placed out of reach of small children in accordance with household safety guidelines.

For a local AKIA Screens contact or Technical Support, please visit

www.akiascreens.com