

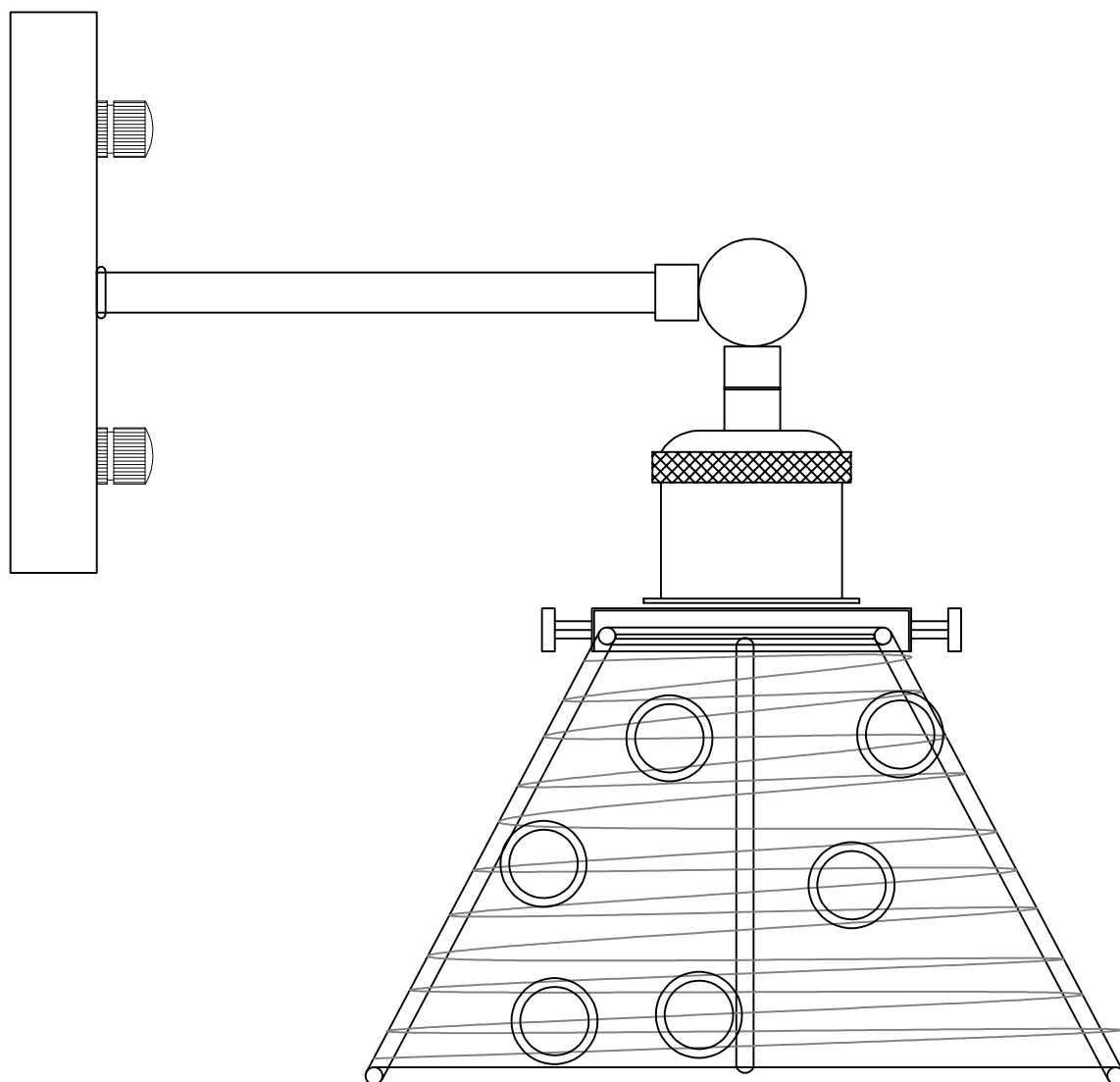

Parrot Uncle

W2207110V



English / Español / Français

www.parrotuncle.com

W2207110V

Installation & Operating Instructions for the
Parrotuncle Owner's Installation ,Manual
WARNING: SHUT POWER OFF AT FUSE OR CIRCUIT BREAKER

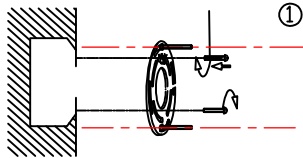

Install the bracket on top of the box

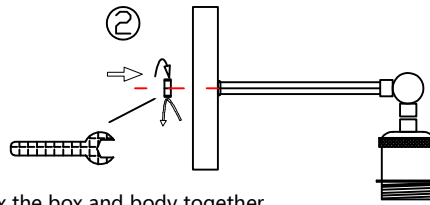

Fix the box and body together

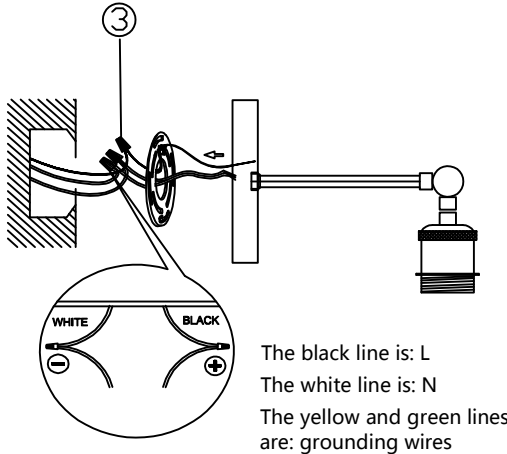

The black line is: L
The white line is: N
The yellow and green lines
are: grounding wires

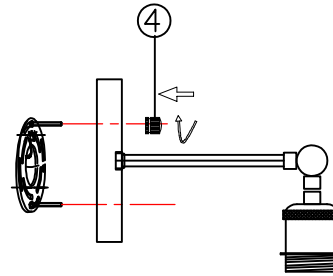

Fix the bracket screws and align
them with the two holes in the box,
and install the striped nuts

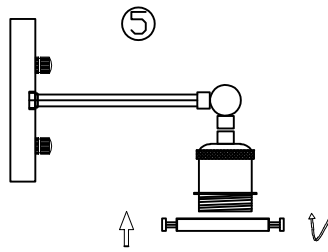

Install decorative flat cover

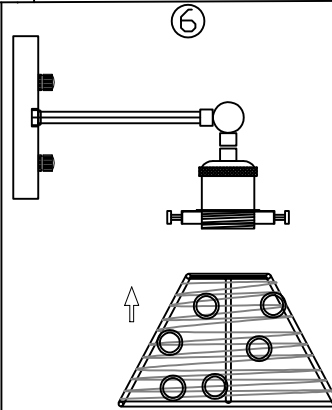

Install the lampshade

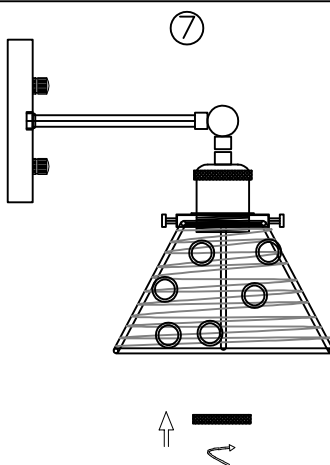

Install the lamp cap ring

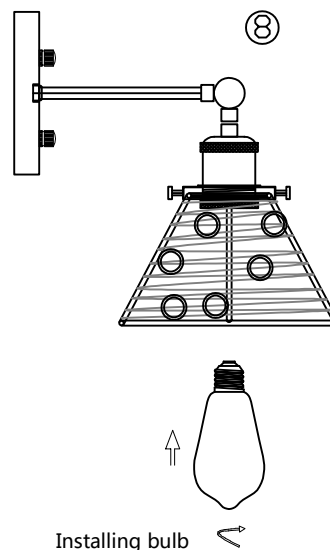

Installing bulb

TECHNICAL INFORMATION

SKU	Nominal voltage	light
W2207110V	AC:110-120V	1*E26 MAX.40W (Not included)

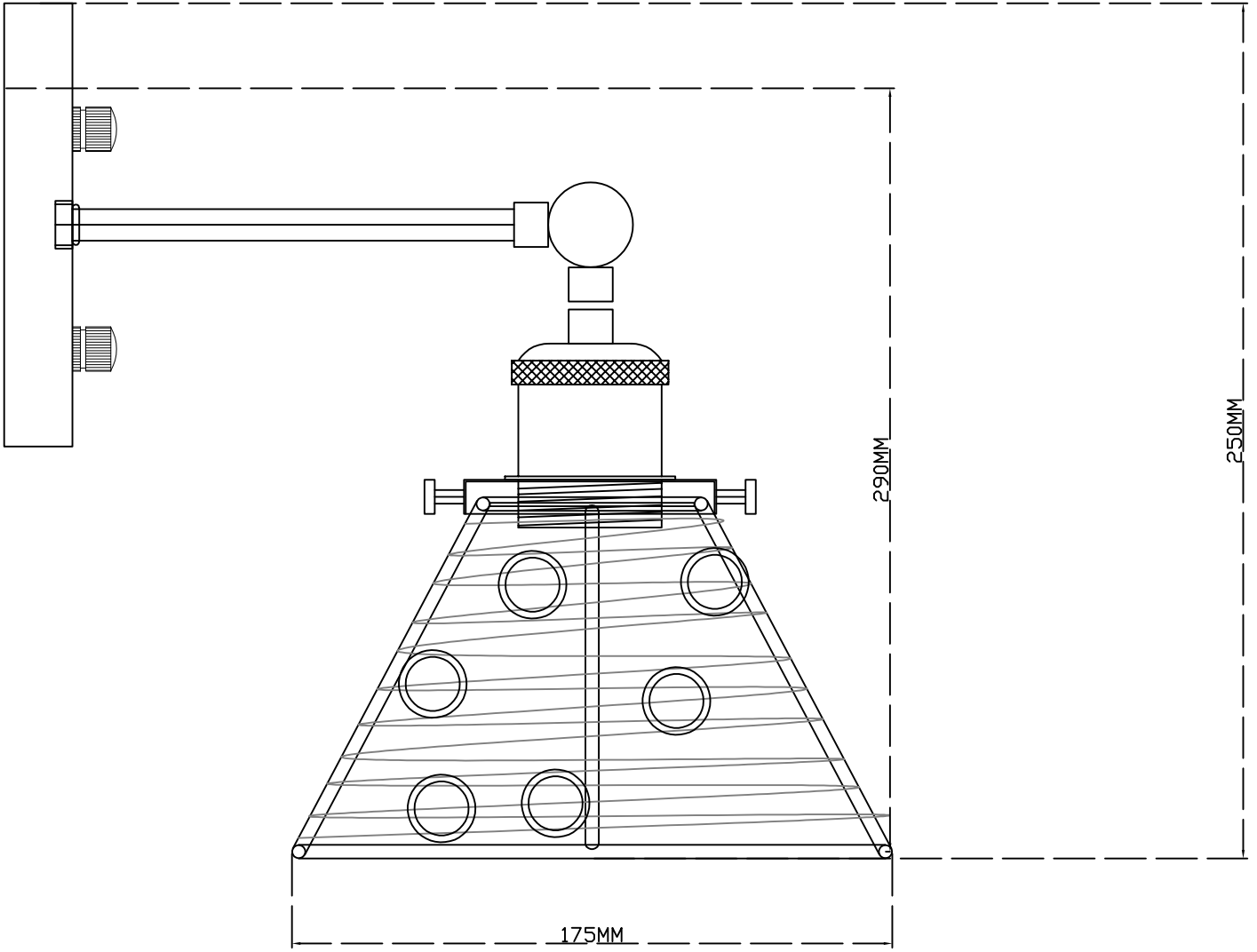



Parrot Uncle

MADE IN CHINA