

PW220306110V

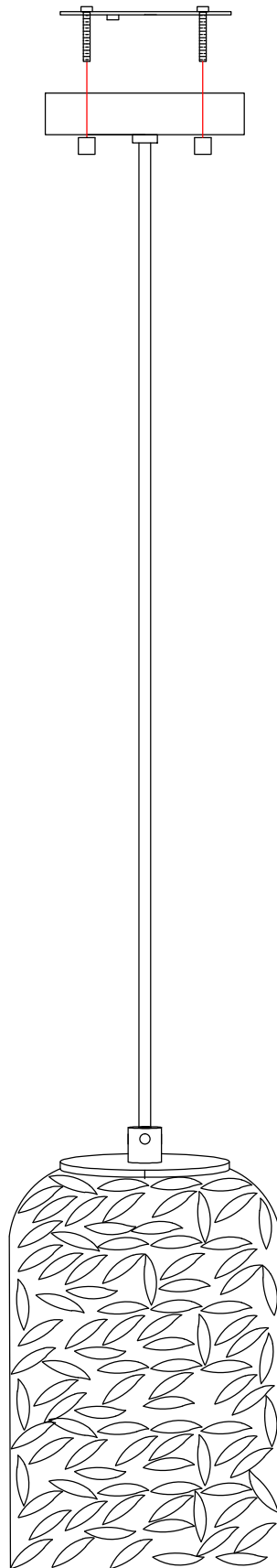

NOTE: ALWAYS TURN POWER OFF BEFORE INSTALLING LIGHTING FIXTURES!

IMPORTANT: YOU SHOULD USE A QUALIFIED ELECTRICIAN TO INSTALL THIS FIXTURE.

Installation (see Fig.A & B)

1. Disconnect power at main electrical panel before installation.
2. A) Attach the **fixture screws** to the **mounting strap**, or **universal mounting plate** (whichever is provided). (Fig.A)
 B) If the fixture uses a single 1/8" IPS **nipple** for mounting, thread the 1/8" IPS **hex nut** and **lock washer** onto the **nipple**, and screw the **nipple** into the **mounting strap**, without tightening the **hex nut**. (Fig.B)
3. Pull the **supply wires** out from the **outlet box**, and mount the **mounting strap** or the **universal mounting plate** to the **outlet box**, using **box screws**.

Wiring (see Fig.C)

4. Split the conductors of the **fixture wire** about 4 inches. Being carefull not to expose any of the wire inside of the insulation.
5. Connect the **fixture ground wire** and the **outlet box ground wire** to **mounting strap** with GREEN hex-head **ground screw** to tapped hole in **mounting strap** marked "GND".
6. Connect the half of the **fixture wire** that is white, marked, or has a ribbed surface to the **outlet box supply wire** (WHITE). Connect the other half of the **fixture wire** that is black, unmarked, or has a smooth surface to the **outlet box supply wire** (BLACK or RED). Use **wirenuts** provided.
7. Spread the electrical splices so that the black wire are on one side of the **outlet box** and the white wire are on the other side.
8. Place the **canopy** on the fixture over the **outlet box** and onto the **fixture screws** (or **nipple**), and adjust the #8-32 **fixture screws** (or **nipple**) until they protrude out from the **canopy**. Remove the **canopy** and secure the position of the **fixture screws** (or **nipple**) by tightening the **hex nut** against the **mounting strap**. Place the **canopy** back onto the **fixture screws**, (or **nipple**), and secure into place using the **decorative nuts**.

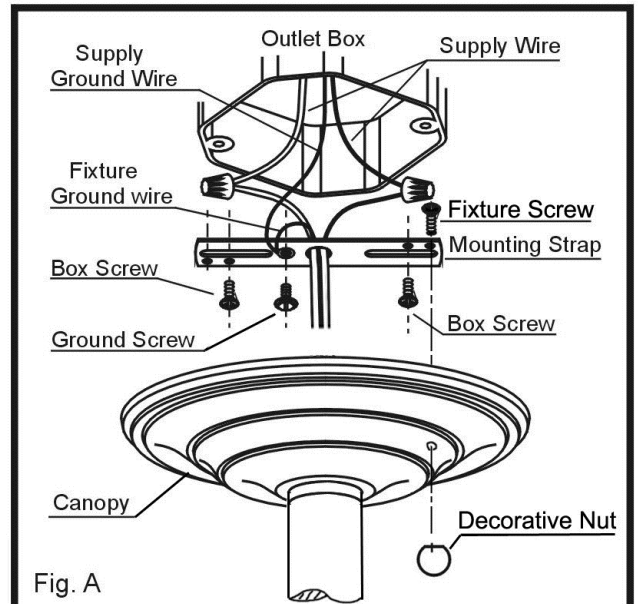

Fig. A

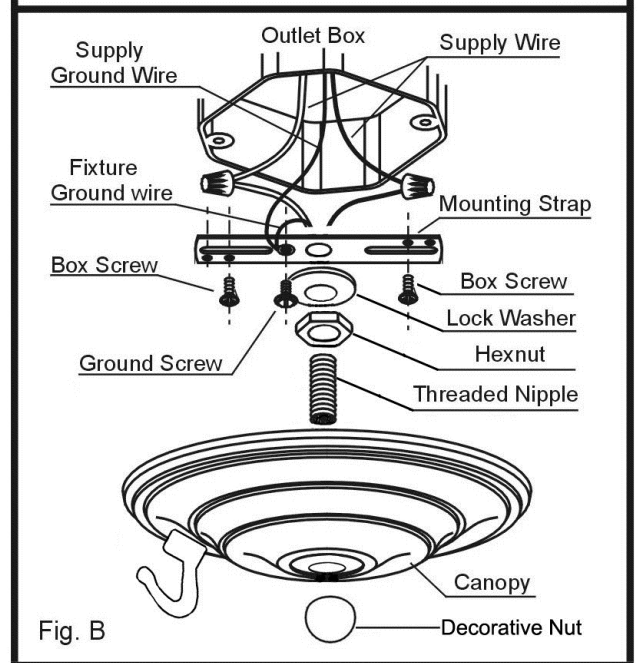

Fig. B

Grounding Detail

Connect Black or Red House Wire to:	Connect White House Wire to:
Black	White
Parallel cord - SPT I & II (round & smooth)	Parallel cord - SPT I & II (square & ridged)
Clear, Brown, Gold or Black (without tracer)	Clear, Brown, Gold or Black (with tracer)
Insulated Wire (Other than GREEN) with copper conductor	Insulated Wire (Other than GREEN) with silver conductor

Fig. C