

11 GAL AIR COOLER

——— JH-370Y ———

PRODUCT USE GUIDE

INTRODUCTION

Thank you for choosing our fan.

This owner's manual will provide you with valuable information necessary for the proper care and maintenance of your new product.

Please take a few minutes to read it.

TABLE OF CONTENTS

SECTION 1

INTRODUCTION	PAGES 1
IMPORTANT INSTRUCTIONS	PAGES 3-4

SECTION 2

TECHNICAL PARAMETERS	PAGES 5
PRODUCT DIAGRAM	PAGES 5
PACKAGE INCLUDES	PAGES 6

SECTION 3

ASSEMBLY INSTRUCTIONS	PAGES 6
OPERATION INSTRUCTIONS	PAGES 7-8

SECTION 4

PANEL CONTROL	PAGES 9-10
REMOTE CONTROL	PAGES 10-11

SECTION 5

CLEANING AND MAINTENANCE	PAGES 12
STORAGE & MAINTENANCE GUIDELINES	PAGES 12
FAULT AND MAINTENANCE	PAGES 13

IMPORTANT INSTRUCTIONS

1. To reduce the risk of fire or electric shock, do not use this product with other speed control devices.
2. Do not soak the main body of the motor in water or rinse under the tap tap.
3. Use this fan only as described in this manual, other uses are not recommended, as it may cause fire or electric shock.
4. To prevent electric shock, do not immerse the plug or cord in water, and do not spray liquid.
5. When the fan is not in use, unplug the fan from the socket, move the fan to another location, and then clean it.
6. After the machine adds water, do not tilt or collide. Push it slowly so as to avoid water overflow. It is strictly forbidden to place it on the inclined ground to prevent accidents.
7. This machine should not be placed at high temperatures and ultra-low temperatures. The water in the water tank in the hot and summer season is easy to deteriorate and produce odor. Please pay attention to updating the water.
8. When packaging and storage are required, it shall be run with normal air for a period of time so that the evaporator is fully dried to prevent the evaporator odor due to the wet surface.
9. This machine has a strong humidification effect, do not use it in a closed environment, if used in a closed environment, please turn off the cold air function.
10. Add water promptly when the water level is below the lowest water line.
11. Do not operate the fan in the presence of explosive or flammable fumes.
12. Avoid contact with moving fan parts.
13. To disconnect, grip the plug and pull it from the wall outlet. Never yank the cord, and always use it on a dry surface.
14. Do not operate any fan with a damaged cord or plug. If the product is damaged, please discard the fan or return it to an authorized service facility for examination or repair.

15. Arrange the cord away from walking and movement areas to avoid tripping.
16. The appliance is not to be used by children or persons with reduced physical, sensory or mental capabilities, or lack of experience and knowledge unless they have been given supervision or instruction.
17. Close supervision is necessary when any appliance is used by or near children. Children should not play with the appliance.
18. Do not leave the fan running unattended.
19. Remove the power before removing the protective housing.

TECHNICAL PARAMETERS

Model No.	JH-370Y
Item Name	11 Gal AIR COOLER
Rated Voltage	120V (60Hz)
Rated Power	120W
3 Mode Fan Speeds	Low / Medium / High
Swing	Vertical and Horizontal
Fan Height	37 Inch
Package Size	37.4×20.6×14.3 Inch

PRODUCT DIAGRAM

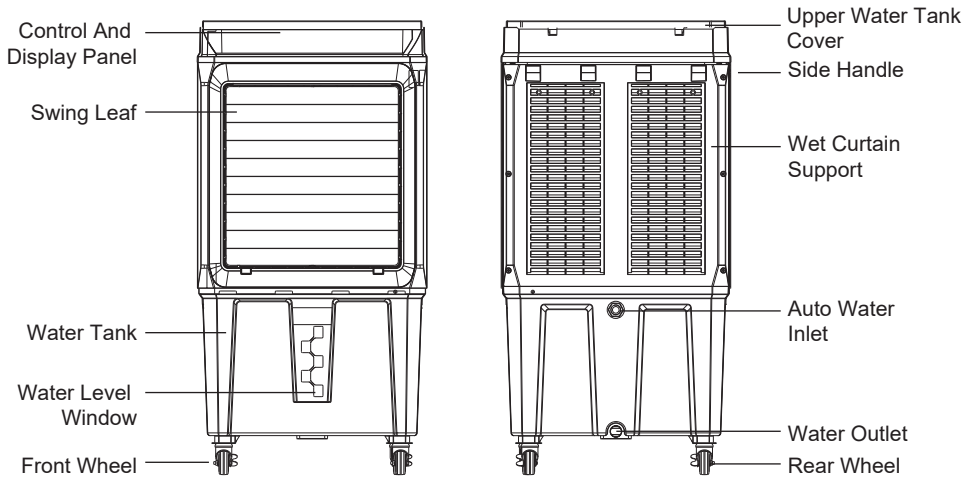

PACKAGE INCLUDE

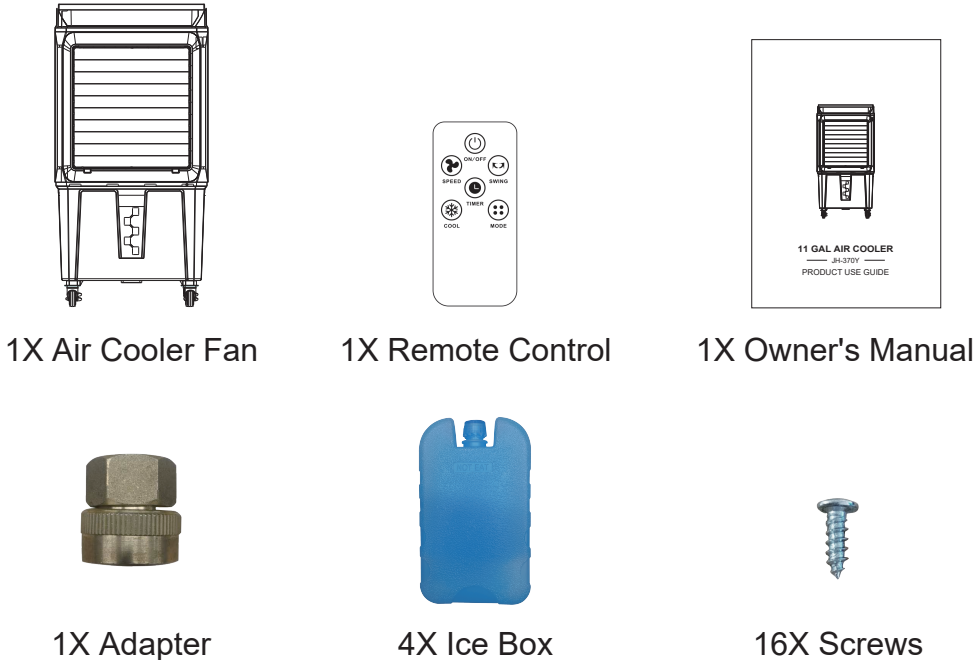

ASSEMBLY INSTRUCTIONS

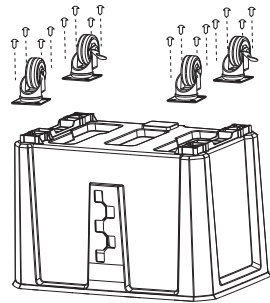

Align the positioning holes in the base with the positioning holes above the wheels, and tighten the screws.

NOTE:
The wheel with a lock is the rear wheel, and the wheel without a lock is the front wheel.

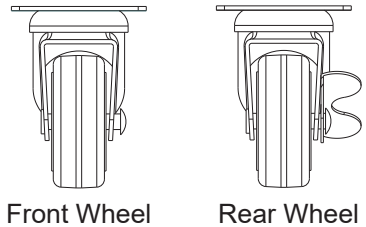

OPERATION INSTRUCTIONS

1. MANUAL ADD WATER:

- Open the upper flip cover and add water slowly (Figure A).
- Observe the water level through the water level window, control the water increase.
- For your and your family's health, you must use clean tap water. Please unplug it before adding water.
- Do not splash water into the motor and surrounding parts to avoid leakage accidents.
- Make sure the water level in the water tank exceeds the minimum level (Indicated by "Min") (Figure B).

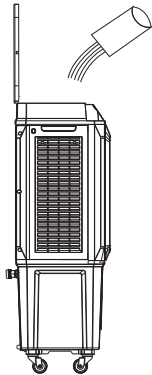

Figure A

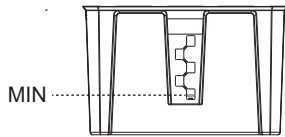

Figure B

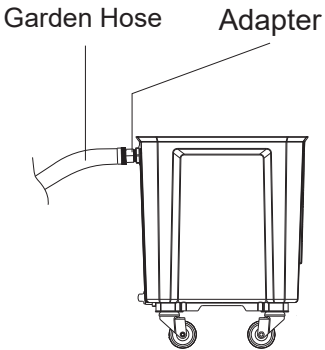

Figure C

2. CONTINUOUS FILL

- Install the adapter to the automatic water inlet on the back of the product.
- Screw the garden hose into the other end of the adapter.
- Turn on the faucet and add water to the tank (Figure C).
- The adapter specifications: 3/4" GHT Female to 1/2" NPT Female.
- The faucet does not need to be turned off, the control device inside the water tank will control the water level always to keep the maximum.
- If there is a water leak, twine some water pipe sealing tape to the connections on both sides of the adapter.

3. THE USAGE OF ICE-BOX:

- If you use the ice box for the first time: open the lid, inject water up to the scale, then tighten the lid.
 - Set aside for 30-40minutes, till the water and ice crystal mix completely.
 - Put the ice box in the freezer of the refrigerator for two hours.
 - Take the ice box out and put it into the air cooler's ice container to cool down the water temperature.
 - After using it for a long time, the ice crystal turns to jelly, please put it in the refrigerator again. It can be recycled and reused.
 - The drain is at the bottom, as shown in Figure D.
 - Rotate and pull out the silicone plug of the water outlet, the body is tilted, and the water tank can be completely emptied. The machine should be drained and cleaned regularly.
- Note: Please empty the water tank if it will not be used for a long time.

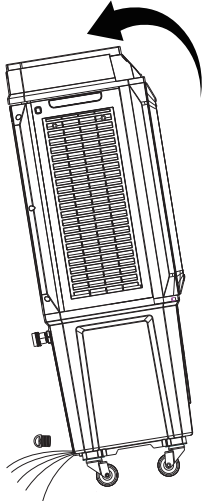
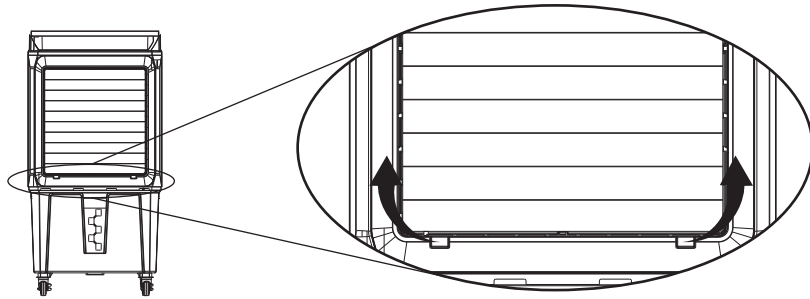



Figure D

PANEL CONTROL





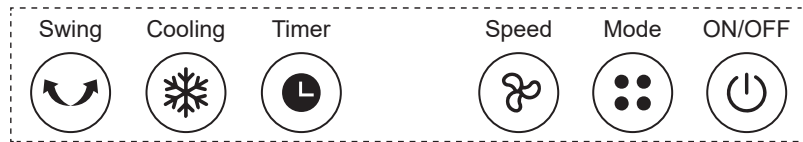

NOTE:

Before using this product, please lift up the swing leaf.



Place the unit on a firm-level surface and plug it into a socket. The power indicator light reminding this product is in standby mode. Turn on the  button, the default is low speed. Press it again, and the machine is on standby.



-  **ON/OFF Button:**
Press this button to open the air cooler. Press this button at any state to stop the operation.
-  **Speed Button:**
Press this button to change the speed between low / medium / high.
-  **Mode Button:**
Press this button to change the fan mode between normal mode and natural mode.
-  **Swing Button:**
Press this button to control the left and right swings, and press it again to stop swinging.
-  **Timer Button:**
Press this button to set the timer, max 12 hours.
-  **Cooling Button:**
Press this button to open or close the cooling system.

NOTE:

Do not open the cooling system when the water tank is empty. If the water tank is empty, the icon is shining and the buzzer hints about 10 seconds, the pump switch is cut off automatically.

REMOTE CONTROL

NOTE:

Before using the remote control, remove the plastic insulating film located under the battery.

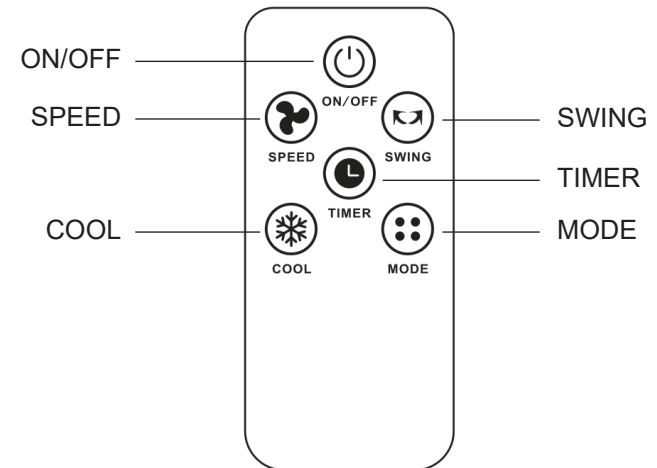
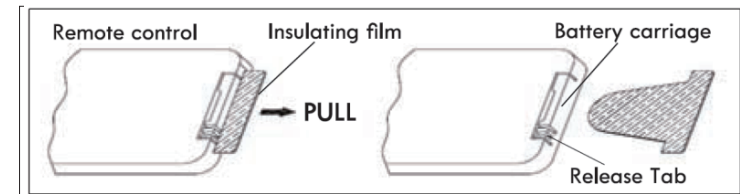

- The remote control must be pointed directly at the receiver on the fan when using. If the remote control is not pointed directly toward the receiver, the range will be decreased
- The remote control may not operate in a room where heavy machinery is operating
- Do not block the line of sight between the remote control and the receiver
- Handle the remote control with care. Do not drop the remote control on the floor or bang it against hard objects

Guidelines for use of batteries

- Before first use:

Pull the protective film to remove it. The remote control is now ready for use.

- To replace the battery:

Open the battery compartment on the back of the remote control and replace the used battery with a new one. Battery type: CR2025.

Dispose of the battery

- The battery must be brought to a household hazardous waste collection site for proper handling.

CLEANING AND MAINTENANCE

NOTE:

After a long-time operation, dust accumulation on the wet curtain would affect the airflow and air purification. Please clean the machine regularly.

1. Clean wet curtain

Turn off the power, loose the screws in the back-cover plate, and take out the back-cover plate.

Loosen the plastic nut on the wet curtain to remove the back wet curtain. clean it with a soft brush and mild detergent, rinse it with water, and dry it under the sunshine, then install it back into the machine.

If the dirt is hard to remove after long-term usage, please change to a new wet curtain.

2. Clean the surface

Turn off the power, and clean it with mild detergent and a soft cloth.

NOTE:

Control panel shall not be touched by water.

STORAGE & MAINTENANCE GUIDELINES

1. Be sure to unplug the power cord from the outlet before cleaning.
2. Plastic parts should be cleaned with mild soap and a damp cloth or sponge. Do not submerge the unit in water to clean it. Thoroughly remove soap with clean water.
3. Be sure not to get water or other liquid inside the fan motor.
4. Dry all parts completely before reassembling and reconnecting to a power source.
5. Store the fan in a cool, dry location when not in use. To prevent dust and dirt build-up, use the original packaging to repack the unit.

FAULT AND MAINTENANCE

Trouble	Cause	Solution
Product not work	1. The power cord is unplugged or in poor contact.	1. Plug the power back firmly or try plugging it into a different outlet to connect the power.
	2. LED screen is damaged.	2. Contact customer service & repair center.
	3. Not working after a while or for other reasons.	3. Please provide the video and contact customer service & repair center.
Bad cooling effects	1. Air inlet or air outlet clogged or there are other heat sources.	1. Remove the obstruction or remove other heat sources.
	2. Other reasons.	2. Please provide the unusable video, and contact customer service & repair center.
Water pump doesn't work	1. The water level of the water tank is lower than the minimum water level scale.	1. Adding water exceeds the minimum water level scale.
	2. The cooling mode is not turned on.	2. Turn on the cooling mode.
	3. Other reasons.	3. Please provide the unusable video, and contact customer service & repair center.
The remote control does not work	1. Exceeding the control range of the remote control 16ft.	1. Bring the remote control close to the Air conditioner and make sure it is pointed at the product.
	2. The remote control didn't aim at signal receptor on unit.	
	3. The batteries have no electricity it.	2. Replace the batteries.
Lack of accessories	1. Lack of ice box.	1. Contact customer service & repair center.
	2. Lack of wheel or screw.	