

Assembly Instructions For

HL-955S

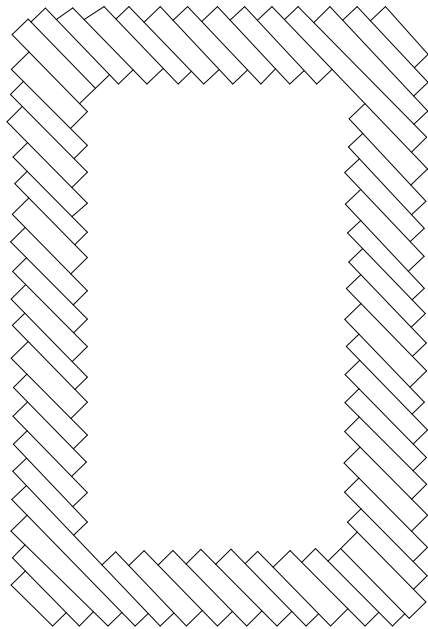

1. Carefully unpack and identify all parts before assembly.
2. Carefully hang mirror onto wall.

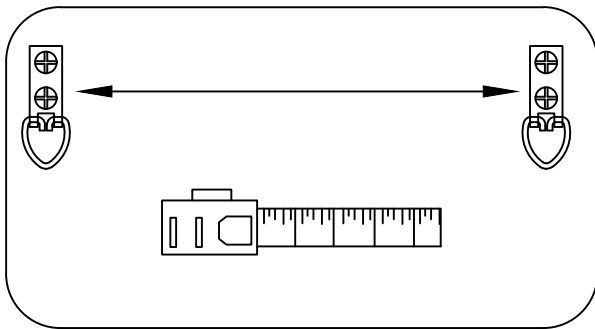

1. Use a tape measure to measure the distance between the two hooks

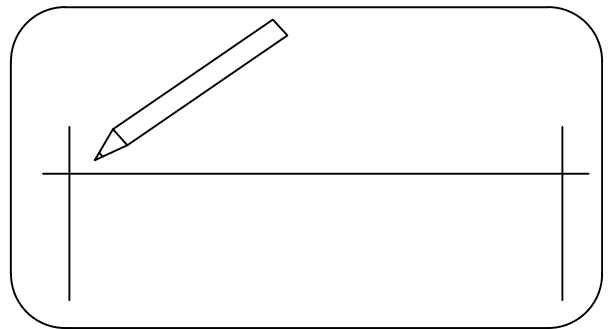

2. Use a pencil to draw flat lines on the wall. The intersection point is the point of punching

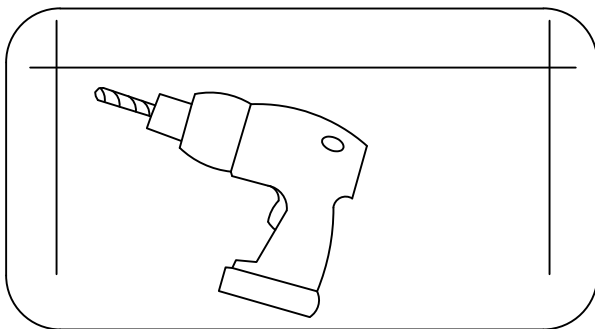

3. Drill holes at the intersection with an electric drill

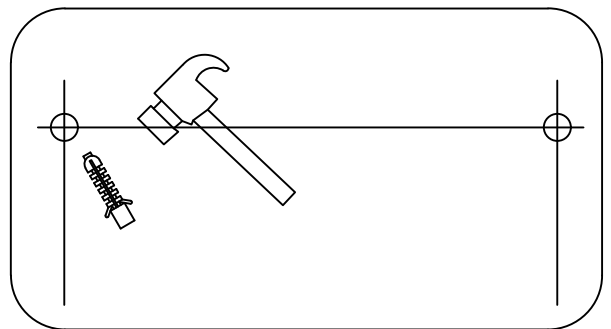

4. Hammer the expansion material into the hole

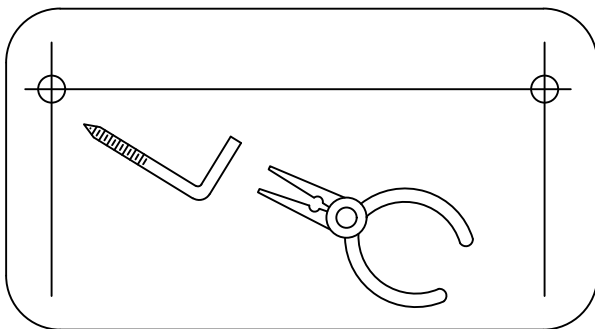

5. Insert the screws using a tong

6. The hanging mirror is installed