

IMPORTANT INSTRUCTIONS & OPERATING MANUAL

HOUSELUX Casita TRIM 23(EF23M)
HOUSELUX Casita TRIM 26(EF26M)
HOUSELUX Casita TRIM 28(EF28M)
HOUSELUX Casita TRIM 30(EF30M)
HOUSELUX Casita TRIM 33(EF33M)
HOUSELUX Casita TRIM 33W(EF33WM)
HOUSELUX Casita TRIM 36(EF36M)
HOUSELUX Casita TRIM 40(EF40M)
HOUSELUX Casita TRIM 50(EF50M)

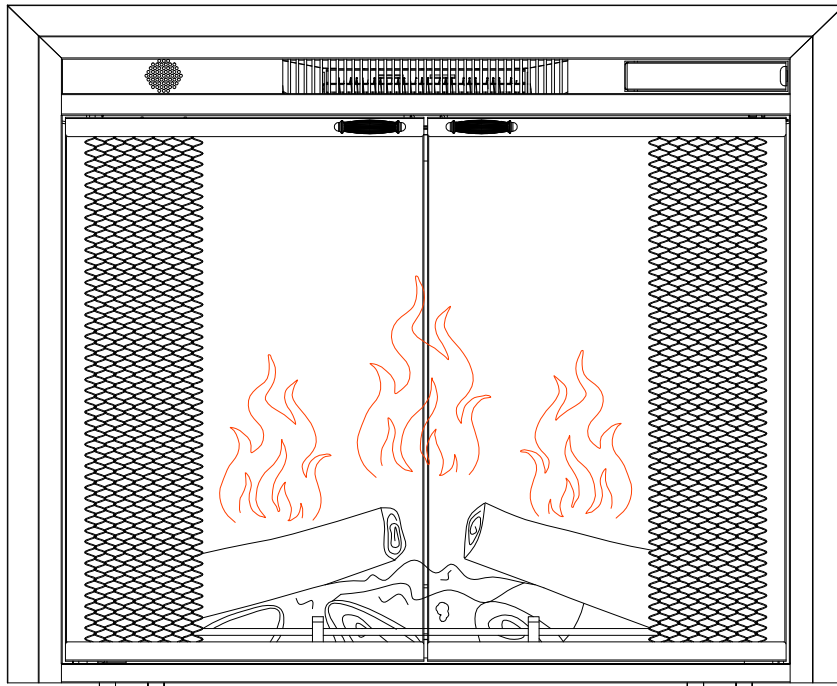

⚠ WARNING

Read and understand this entire owner's manual, including all safety information, before plugging in or using this product. Fail to do so could result in fire, electric shock, or serious personal injury.

⚠ CAUTION

Keep this owner's manual for future reference. If you sell or give away this product, make sure this manual accompanies this product.

NO VENTING REQUIRED
120V AC; 60 Hz; 1500 Watts



CONTENTS

Important Safety Information	3
Preparation	5
Product Dimension	5
Assembly	7
Battery Information	7
Operation	8
Control Panel	9
Remote Control	10
Care and Maintenance	11
Schematic Diagram	12
FAQ – Frequently Asked Questions	13
Troubleshooting Guide	14
Limited Warranty	15
Customer Service	15

IMPORTANT SAFETY INFORMATION!

When using electrical appliances basic precautions should always be followed to reduce the risk of fire, electric shock and injury to persons, including the following:

- 1) Read all instructions before installing or using this heater.
- 2) This heater is hot when in use. To avoid burns, do not let bare skin touch hot surfaces.
Keep combustible materials, such as furniture, pillows, bedding, papers, clothes, etc. and curtains at least 0.9 m from the front of the heater and keep them away from the sides and rear.
- 3) Extreme caution is necessary when any heater is used by or near children or the infirm and whenever the heater is left operating and unattended.
- 4) Do not operate any heater after it malfunctions. Disconnect power at service panel and have heater inspected by a reputable electrician before reusing.
- 5) Do not use outdoors.
- 6) To disconnect heater, turn controls to off, and turn off power to heater circuit at main disconnect panel (or operate internal disconnect switch if provided).
- 7) Do not insert or allow foreign objects to enter any ventilation or exhaust opening as this may cause an electric shock or fire, or damage the heater.
- 8) To prevent a possible fire, do not block air intakes or exhaust in any manner.
- 9) A heater has hot and arcing or sparking parts inside. Do not use it in areas where gasoline, paint, or flammable vapors or liquids are used or stored.
- 10) Use this heater only as described in this manual. Any other use not recommended by the manufacturer may cause fire, electric shock, or injury to persons.
- 11) This heater may include an audible or visual alarm to warn that parts of the heater are getting excessively hot. If the alarm sounds (or illuminates), immediately turn the heater off and inspect for any objects on or adjacent to the heater that may have blocked the airflow or otherwise caused high temperatures to have occurred. **DO NOT OPERATE THE HEATER WITH THE ALARM SOUNDING (OR ILLUMINATING).**
- 12) "SAVE THESE INSTRUCTIONS"

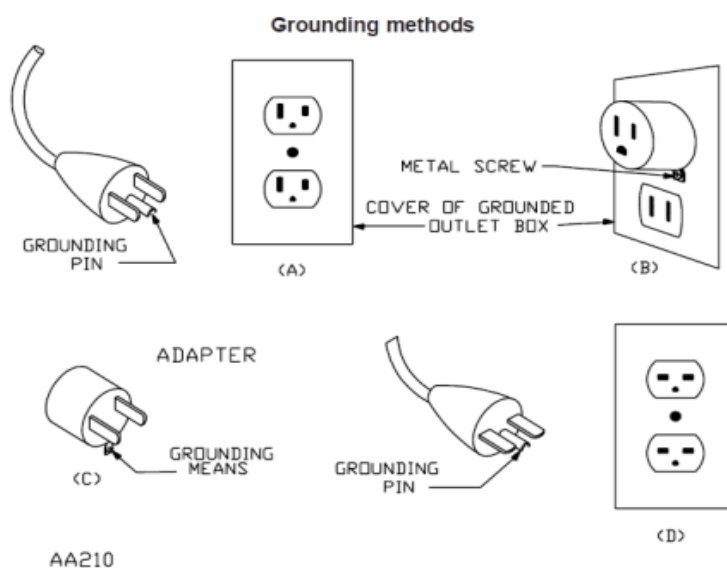

This heater is for use on 120 volts. The cord has a plug as shown below Figure. An adapter as shown at C is available for connecting three-blade grounding-type plugs to two-slot receptacles. The green grounding lug extending from the adapter must be connected to a permanent ground such as a properly grounded outlet box. The adapter should not be used if a three-slot grounded receptacle is available.

Instructions importantes

1. Lisez toutes les instructions avant d'installer ou d'utiliser ce radiateur.
2. Ce radiateur est chaud lorsqu'il est utilisé. Pour éviter les brûlures, ne laissez pas la peau nue toucher les surfaces chaudes. Gardez les matériaux combustibles, tels que les meubles, les oreillers, la literie, les papiers, les vêtements, etc. et les rideaux à au moins 0,9 m de l'avant du radiateur et éloignez-les des côtés et de l'arrière.
3. Une extrême prudence est nécessaire lorsqu'un radiateur est utilisé par ou près des enfants ou des invalides et chaque fois que le radiateur est laissé en fonctionnement et sans surveillance.
4. Ne faites pas fonctionner de radiateur après les dysfonctionnements. Débranchez l'alimentation au panneau de service et faites inspecter le radiateur par un électricien réputé avant de réutiliser.
5. N'utilisez pas à l'extérieur.
6. Pour déconnecter le radiateur, tourner les commandes vers OFF et désactiver l'alimentation sur le circuit du chauffage au panneau de déconnexion principale (ou faire fonctionner l'interrupteur de déconnexion interne s'il est fourni).
7. Ne pas insérer ou permettre aux objets étrangers de pénétrer dans une ventilation ou une ouverture d'échappement car cela peut provoquer un choc électrique ou un incendie, ou endommager le radiateur
8. Pour éviter un éventuel incendie, ne bloquez pas les apports d'air ou ne vous échappez en aucune façon.
9. Un radiateur a des pièces chaudes et arc ou étincelles à l'intérieur. Ne l'utilisez pas dans les zones où l'essence, la peinture ou les vapeurs ou liquides inflammables sont utilisés ou stockés.
10. Utilisez ce radiateur uniquement comme décrit dans ce manuel. Toute autre utilisation non recommandée par le fabricant peut provoquer un incendie, un choc électrique ou une blessure aux personnes.
11. Ce radiateur peut inclure une alarme audible ou visuelle pour avertir que les parties du radiateur deviennent excessivement chaudes. Si l'alarme sonne (ou illumine), éteignez immédiatement le radiateur et inspectez tous les objets ou adjacents au radiateur qui pourrait avoir bloqué le flux d'air ou autrement provoqué des températures. Ne faites pas fonctionner le radiateur avec le sondage d'alarme (ou illuminant).
12. «Enregistrez ces instructions»

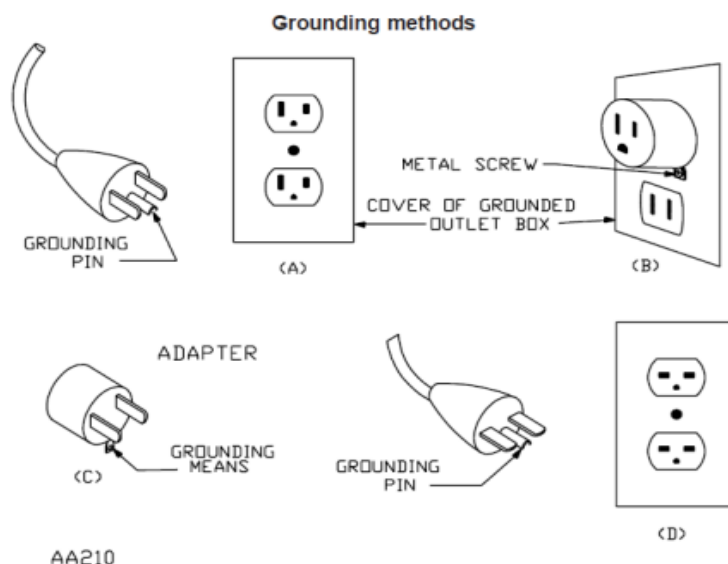



Ce radiateur est utilisé sur 120 volts. Le cordon a une fiche comme indiqué ci-dessous. Un adaptateur comme indiqué sur C est disponible pour connecter les bouchons de type de mise à la terre à trois lames aux réceptacles à deux plans. La patte de mise à la terre verte s'étendant de l'adaptateur doit être liée à un sol permanent comme une boîte de sortie correctement mise à la terre. L'adaptateur ne doit pas être utilisé si un réceptacle mis à trois places est disponible.

PREPARATION

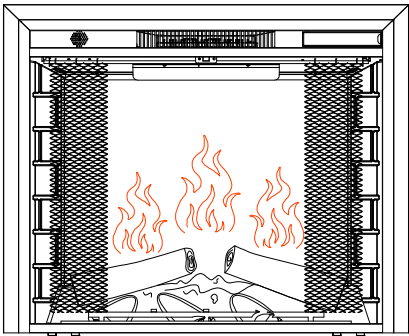
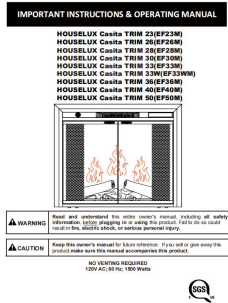
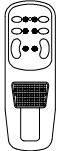

DO NOT use this Electric Fireplace if any part has been **under water**. Immediately call a qualified **service technician** to inspect and to replace any part of the electrical system if necessary. Keep **plastic** wrapping away from **children**.

Unpacking the Electric Fireplace. Remove all parts and hardware from the carton and place them on a clean, soft, dry surface. Check the parts list to make sure nothing is missing. Dispose of packaging materials properly. Please recycle whenever possible. Keep the original packaging for future transport and/or storage.

 <p>Fireplace (1 pc)</p>	 <p>Manual (1 pc)</p>
 <p>Remote control (1 pc)</p>	 <p>AAA battery (2 pcs)</p>

PRODUCT DIMENSIONS

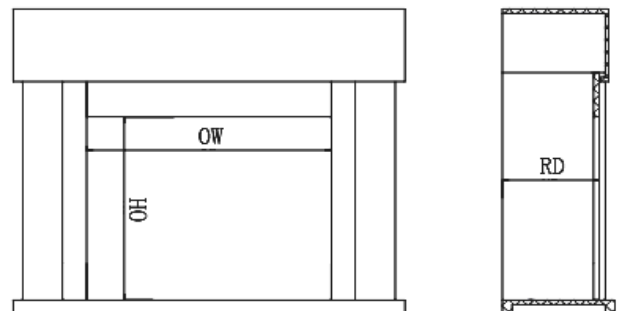
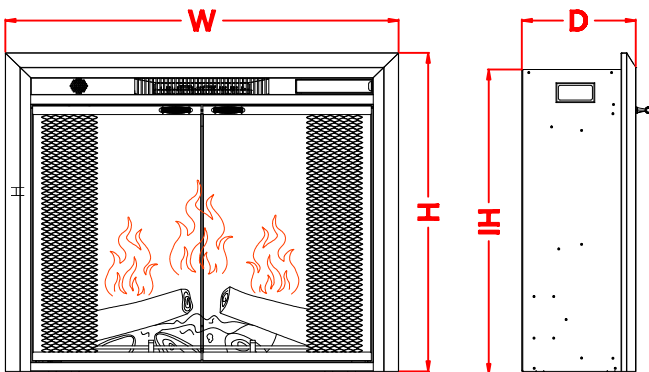

Fireplace Mantel

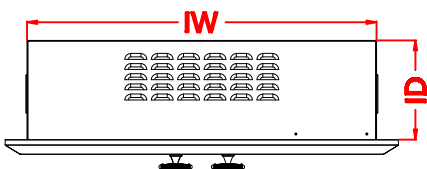

Fireplace Insert

Units:inch

Model	Insert Width (IW)	Insert Height (IH)	Insert Depth (ID)
EF23M	21.95	19.80	7.70
EF26M	25.30	20.12	7.70
EF28M	27.11	23.62	7.70
EF30M	29.59	23.62	7.70

Model	Insert Width (IW)	Insert Height (IH)	Insert Depth (ID)
EF33M	32.23	26.22	7.70
EF33WM	32.23	19.80	7.70
EF36M	36.60	26.22	7.70
EF40M	39.55	26.22	7.70
EF50M	46.60	26.22	7.70

Units:mm

Fireplace Insert Size

Model	Width (W)	Height (H)	Depth (D)	Advise mantel opening size		Advise mantel minimum depth (RD)
				Width (OW)	Height (OH)	
EF23M	644	536	224.6	568-571	508-511	215-220
EF26M	729	544	224.6	653-656	516-219	215-220
EF28M	775	628	224.6	699-701	605-608	215-220
EF30M	838	628	224.6	762-764	605-608	215-220
EF33M	905	699	224.6	830-833	671-674	215-220
EF33WM	905	536	224.6	830-833	508-511	215-220
EF36M	1016	699	224.6	941-944	671-674	215-220
EF40M	1091	699	224.6	1015-1018	671-674	215-220
EF50M	1270	699	224.6	1195-1198	671-674	215-220

Units:inch

Model	Width (W)	Height (H)	Depth (D)	Advise mantel opening size		Advise mantel minimum depth (RD)
				Width (OW)	Height (OH)	
EF23M	25.4	21.1	8.84	22.4-22.5	20.0-20.1	8.5-8.7
EF26M	28.7	21.4	8.84	25.7-25.8	20.3-20.4	8.5-8.7
EF28M	30.5	24.7	8.84	27.5-27.6	23.8-23.9	8.5-8.7
EF30M	33.0	24.7	8.84	30.0-30.1	23.8-23.9	8.5-8.7
EF33M	35.6	27.5	8.84	32.7-32.8	26.4-26.5	8.5-8.7
EF33WM	35.6	21.1	8.84	32.7-32.8	20.0-20.1	8.5-8.7
EF36M	40.0	27.5	8.84	37.0-37.1	26.4-26.5	8.5-8.7
EF40M	43.0	27.5	8.84	40.0-40.1	26.4-26.5	8.5-8.7
EF50M	50.0	27.5	8.84	47.0-47.1	26.4-26.5	8.5-8.7

ASSEMBLY



ALWAYS unplug this fireplace heater **before assembly** or **cleaning**, or **before relocating**. Failure to do so could result in **electric shock**, **fire**, or **personal injury**.

KEEP drapery and other furnishings at least **3ft /0.9m** from the **front and sides** of the electric fireplace.

AFTER installation, ensure that there is **≥0.004 m² ventilation area** between **inside and outside** of fireplace mantel.

Your new electric fireplace may be installed virtually anywhere in your home. However, when choosing a location ensure that the general instructions are followed. For best results, install out of direct sunlight. Power supply service must be either completed or placed within the electric fireplace prior to finishing to avoid reconstruction.

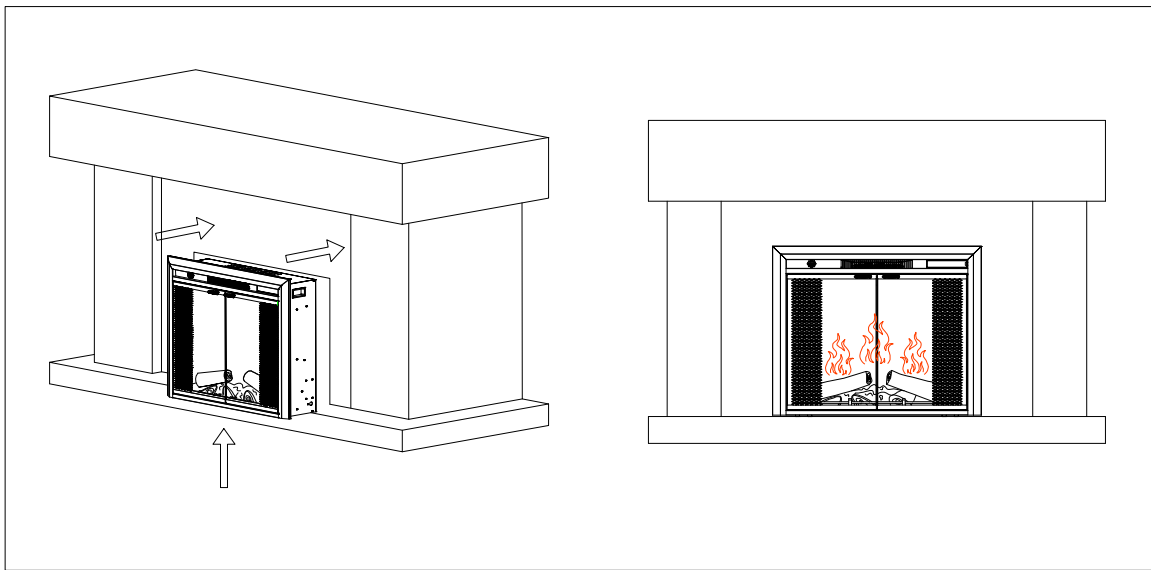

When moving the insert into mantel, Do not let bottom of insert touch the mantel to avoid the scratch.

BATTERY REPLACEMENT

NOTE: The remote control not include the batteries.

NOTE: Do not mix old and new batteries.

Do not mix alkaine,standard(carbon zinc),or rechargeable(nicad,nimh,ect.)batteries.

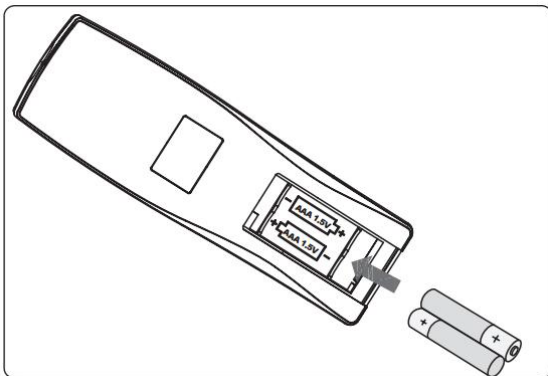

Note:

Battery disposal
Please always dispose of batteries
at a suitable recycling point.

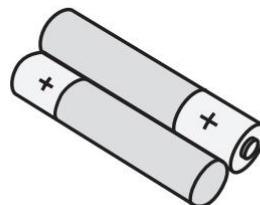

CAUTION:

- Always purchase the correct size and grade of battery most suitable for the intended use.
- Replace all batteries of a set at the same time.
- Clean the battery contacts and also those of the device prior to battery installation.
- Ensure the batteries are installed correctly with regard to polarity (+ and -).
- Remove batteries from equipment which is not to be used for an extended period of time.
- Remove used batteries promptly.

OPERATION



Read and understand this entire owner's manual, including **all safety information**, before plugging in or using this product. Fail to do so could result in **electric shock, fire, serious injury, or death.**

Power

Make sure the Power Switch, located on the control panel, is in the OFF position. Plug the power cord into a 110~120 Volt 15 Amp outlet (see **IMPORTANT SAFETY INFORMATION** on **Pages 3 and 4**). Make sure the outlet is in good condition and that the plug is not loose. **NEVER** exceed the maximum amperage for the circuit. **DO NOT** plug other appliances into the same circuit.

Temperature Limiting Control

This heater is equipped with a Temperature Limiting Control. Should the heater reach an unsafe temperature, the heater will automatically turn OFF. To reset:

1. Unplug the power cord from the outlet.
2. Turn the Power Switch on the CONTROL PANEL to OFF. **Wait at least 5 minutes.**
3. Inspect the fireplace to make sure no vents are blocked, or clogged with dust or lint. If they are, use a vacuum to clean the vent areas.
4. With the Power Switch in the OFF position, plug the power cord back into the outlet.
5. If it switches off again, **UNPLUG THE HEATER RIGHT AWAY!** Have the outlets, wiring, and breaker box inspected by a professional. Make necessary repairs before using the heater.

Heater Rating

Maximum heat output: 1500W (5000BTU); Maximum heating area: 400 square feet.

Operation

Review the **IMPORTANT SAFETY INFORMATION** on **Pages 3 and 4** before operating.

NOTICE:





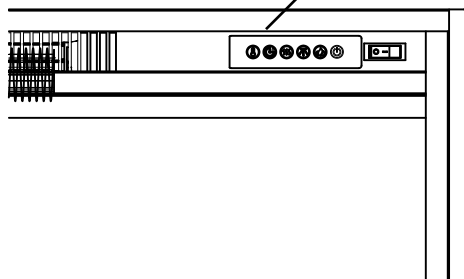

When the heater is first turned on, a slight odor may be present. This is normal and should not occur again unless the heater is not used for a long period of time.

Open a door on the top right side
for operation all functions

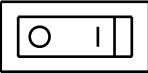

Control Panel

Located on the right and top side panel of the fireplace.

BUTTON	NAME	FUNCTION
	POWER SWITCH	Turn on the main power supply. A long “beep” sound will be heard when the switch is turned on On Position “1”. Note: The remote control will lost the memory for function settings when the switch is turned on Off Position “0”.
	FLAME	Controls flame colors. 3 Settings: (L1 yellow-L2 blue-L3 purple-cycle)
	HEATER	The heater will be cycled Low – High – Heater Off. You will see the screen light illuminates on right of the flame board.The indicator light goes out within 5s. Low: (LO) High: (HI) Note: 1. Fireplace can be used without heater. 2. Whether the heating is working depends on whether the settled temperature by thermostat is higher than the environment temperature. 3. The Fan works anterior to the heater about 10s, and turns off later than the heater about 10s.
	Log Speaker	The log speaker can make the real log burning effect. Press first time to turn on the log speaker, Press second time to turn off the log speaker.
	TOP LIGHT	There are three colors for option. Press the first time for orange color, Press the second time for the blue color, Press the third time for the purple color.
	TIMER	This fireplace is equipped with a timer ranging from 1hr to 9hrs(1H,2H ...9H,Off shown on the LCD display),touch the button once for every 1hr increase.

Remote Control

Control panel Power Switch must be ON to use remote control.

NOTICE: Aim the remote control at the **remote receiver**. Make sure you **hear a beep each time you press the button!** If not, the fireplace **will not respond** to the signal.

NOTICE: Operation for all functions are same as the buttons on the fireplace.

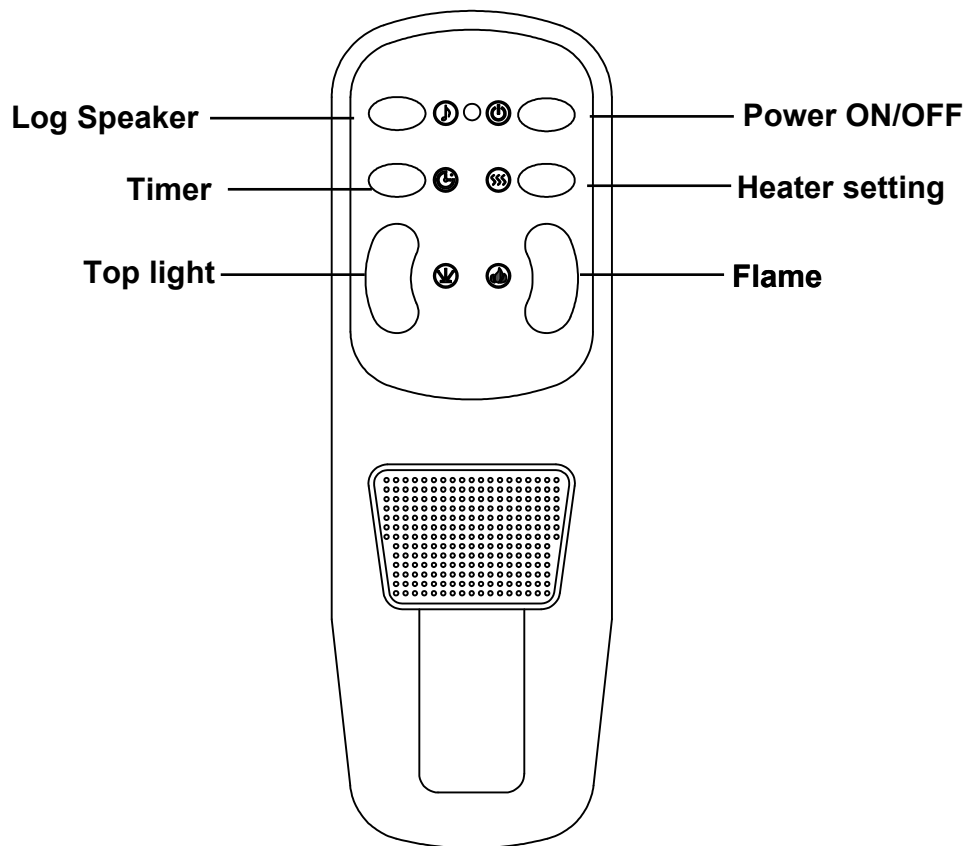

CARE AND MAINTENANCE



ALWAYS turn the heater **OFF** and **unplug the power cord from the outlet** before cleaning, performing maintenance, or moving this fireplace. Failure to do so could result in **electric shock, fire, or personal injury**.

Cleaning



NEVER immerse in water or **spray with water**. Doing so could result in **electric shock, fire, or personal injury**.

Metal:

- Buff using a soft cloth, slightly dampened with a citrus oil-based product.
- **DO NOT** use brass polish or household cleaners as these products will damage the metal trim.

Glass:

- Use a good quality glass cleaner and dry thoroughly with a paper towel or lint-free cloth.
- **NEVER** use abrasive cleansers, liquid sprays, or any cleaner that could scratch the surface.

Plastic:

- Wipe gently with a slightly damp cloth and a mild solution of dish soap and warm water.
- **NEVER** use abrasive cleansers, liquid sprays, or any cleaner that could scratch the surface.

Vents:

- Use a vacuum or duster to remove dust and dirt from the heater and vent areas.
- Clean the exterior of the fireplace with a slightly damp cloth or duster.

Maintenance



Risk of electric shock! DO NOT OPEN! No user-serviceable parts inside!



ALWAYS turn the heater **OFF** and **unplug the power cord from the outlet** before cleaning, performing maintenance, or moving this fireplace. Failure to do so could result in **electric shock, fire, or personal injury**.

Electrical and Moving Parts:

- The fan motors are lubricated at the factory and will not require lubrication.
- Electrical components are integrated in the fireplace and are not serviceable by the consumer.

Storage:

- Store heater in a clean dry place when not in use.

Replacement parts:

- Use only replacement parts supplied by the manufacturer. Use of any other parts, or modifying the fireplace in any way, will void all warranties.
- No internal parts are replaceable or serviceable.



WARNING! No other servicing should be performed by the consumer. Do not attempt to service the unit by yourself.

SCHEMATIC DIAGRAM

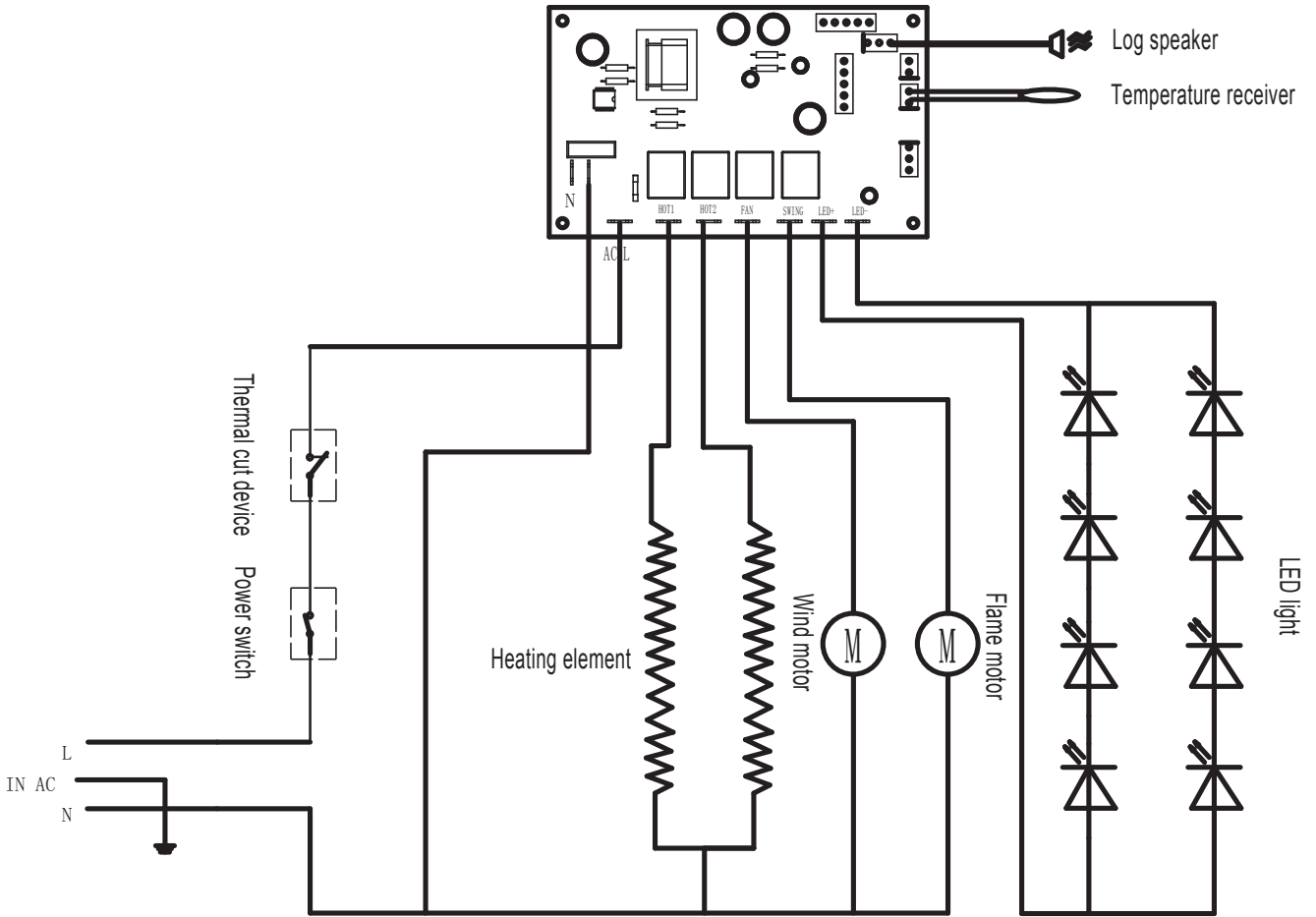

FAQ - FREQUENTLY ASKED QUESTIONS

- **Why does the fan blow before the heat comes on, and after the heater is turned off?**
Heat and cool gradually. The fan blows when the heater is first turned on, and the heat is still heating up. After the heater turns off, the fan will continue to blow air for 10 seconds. This allows the fireplace to cool slowly, and helps prevent overheating.
- **What does the fireplace beep? Can I turn the beeping off?**
The beeps indicate that the signal from the control panel, or remote control, has been received by the fireplace. The beeping cannot be turned off.
- **Why doesn't the fireplace function change when remote control setting changes?**
The fireplace function will only change if there is a beep after pressing the button. If you do not hear a beep, try again. If you hear a beep, the fireplace function will change to match the remote control setting.
- **Why does the remote control not work, or only work sometimes?**
Check to make sure the batteries are good. If necessary, change to new batteries. If the remote control is not aimed properly, if you are too far away, or if you are too far off to the side, the signal may not reach the fireplace. Get closer, aim at the upper top corner of the screen (where the red heat indicator light is located), and try again.
- **How do I change from high heat to low heater?**
The heater is controlled by the heater button on the control panel, or the heater buttons on the remote control.
- **Is the thermostat setting accurate?**
The temperature within a room can vary. Room size, fireplace location, air flow, sunlight, wall type (interior vs. exterior), insulation, etc. all affect temperature. The fireplace setting may not match your home thermostat exactly. This is normal. Try different thermostat setting on your fireplace until you find one that is right for you.

TROUBLESHOOTING GUIDE

PROBLEM	SOLUTION
There is no power to the fireplace, or it does not turn on.	<ol style="list-style-type: none"> 1. Make sure the power cord is plugged into a functioning and properly grounded 15 Amp 120V AC electrical outlet. 2. Make sure the Power Switch on the control panel is ON. 3. If the unit had been working, but then turned off by itself, the temperature limiting control may need to be reset. See page 8 for instructions. 4. Check for damage to the power cord or plug. If damaged, DO NOT USE.
The control panel functions do not work.	<ol style="list-style-type: none"> 1. Make sure the Power Switch on the control panel is turned on. If it is OFF, the functions will not work. 2. If the Power Switch is ON, and the functions do not work, please e-mail us at
The FLAME button doesn't work.	<ol style="list-style-type: none"> 1. Make sure the Power Switch on the control panel is ON. 2. If the Power Switch is ON, and the functions do not work, please e-mail us at
The heater does not work.	<ol style="list-style-type: none"> 1. Make sure the Power Switch on the control panel turned on. 2. Control Panel: Press the heater button on the control panel to override the thermostat at any time. 3. Remote control: Make sure the thermostat is not set too low. If the thermostat is set lower than room temperature, the heater will not turn on. 4. If none of these solutions work, please e-mail us at
The heater does not blow hot air when it turns on and off.	This is normal. The fans blow cool air while the heater gradually heat up. The fans blow after the heater turn off to cool the heater and prevent overheating.
The remote control does not work.	<ol style="list-style-type: none"> 1. Make sure the battery is properly installed. 2. Make sure the Power Switch on the control panel is turned on. The remote control will not work unless the POWER SWITCH on the control panel is turned on. 3. Aim the remote control at the receiver. 4. Remove objects that may be in the way. Items between the remote control and the remote control receiver will block the signal. 5. Don't press the remote control buttons too quickly. Give the unit time to respond to your commands.
The thermostat does not work.	<ol style="list-style-type: none"> 1. Make sure the heater is turned on. The thermostat will not work unless the heater is turned on. 2. Make sure the thermostat is not set too low. If the thermostat is set lower than room temperature, the heater will turn on.

LIMITED WARRANTY

This warrants to the original purchaser that this product is free from defects in material and workmanship as of the date of purchase and that it will, under normal use and proper care, remain one year from the date of purchase. Missing or initially defective parts will be replaced free of charge during the period of this limited warranty. If parts are unavailable, comparable replacement or refund will be given. **The original dated sales receipt is required for all warranty claims.** This warranty does not cover damage which has occurred during transport from the point of purchase to the consumer's home. This warranty does not cover glass, light bulbs, batteries, transportation, labor, or other issues not associated with the manufacture of the product.

This product is for residential use only. Any and all commercial use of this product voids all warranties, and absolves the manufacturer from all liability.

Read and understand all assembly and operating instructions, and all safety information and warnings, before use. The following will void this warranty: Damage caused by tampering, modifying, or altering the fireplace insert in any manner; Damage due to incorrect assembly, improper care, misuse, or abuse; Damage from being used with the wrong power source; Water damage; Damage caused from this insert being used outdoors; Damage caused by using for excessive periods of time; Damage caused by the insert being used in a commercial application; Damage from use as a primary heat source; Other misuse or abuse not specifically listed herein.

This product is not intended to be used as a primary heat source. It is for supplemental heating purposes only.

Model: Casita Trim 23, Casita Trim 26, Casita Trim 28, Casita Trim 30, Casita Trim 33,
Casita Trim 33W, Casita Trim 36, Casita Trim 40, Casita Trim 50.

Power supply: 120V-60Hz

Power consumption: 1500W

Protection class: I

Light bulb: LED