



AEROFANTURE

SWITCH

Ceiling Fan
Installation Manual



TYPE

AT52-01-01B

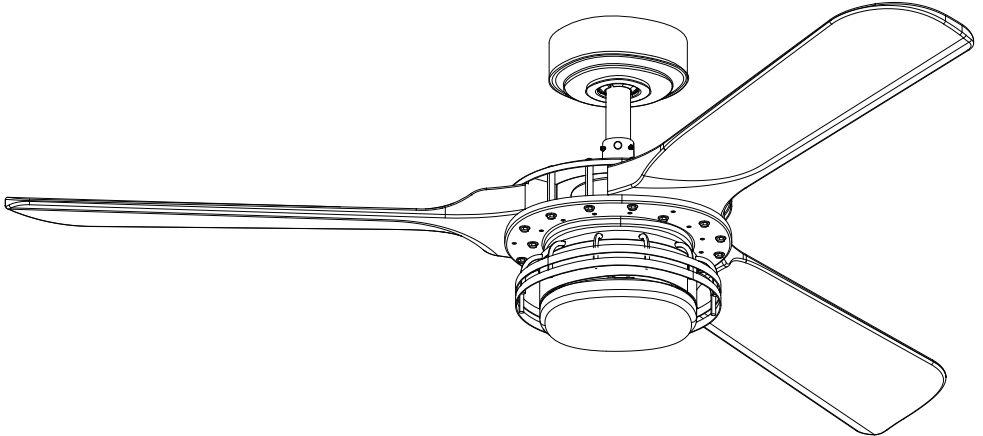

CONTENTS

INSTALLATION & OPERATING INSTRUCTIONS FOR THE AEROFANTURE OWNER'S INSTALLATION, MANUAL

SAFETY TIP P 01

UNPACKING YOUR FAN

CONTAINS P 03

INSTALLING YOUR FAN

STEP 01 - 04 P 04

STEP 05 - 08 P 05

STEP 09 - 10 P 06

STEP 11 P 07

STEP 12 - 13 P 08

OPERATING YOUR REMOTE CONTROL

STEP 01 - 06 P 09

AFTER INSTALLATION

“WOBBLE” P 10
NOISE P 11
CARE AND CLEANING P 11

SWITCH

AT52-01-01B

INSTALLATION & OPERATING INSTRUCTIONS FOR THE AEROFANTURE OWNER'S INSTALLATION, MANUAL

* **WARNING:**

SHUT POWER OFF AT FUSE OR CIRCUIT BREAKER

THANK YOU FOR YOUR PURCHASE

Thank you for purchasing this quality product. To ensure correct function and safety, please **read and save all instructions** before using the product.

SAFETY TIP

- 1 To avoid possible electric shock, turn off the electricity at the main fuse box or circuit panel before you begin the fan installation or before servicing the fan or installing accessories.
- 2 Read all instructions and safety information carefully before installing your fan and save these instructions.
- 3 Make sure all electrical connections comply with local codes or ordinances and the National Electrical Code. If you are unfamiliar with electric wiring, please consult a qualified and licensed electrician.
- 4 Make sure you have a location selected for your fan that allow clear space for the blades to rotate, and at least seven (7) feet of clearance between the floor and the fan blade tips. The fan should be mounted at least thirty (30) inches from walls or other upright structures.
- 5 **WARNING:** The outlet box and ceiling support joist used must be securely mounted, and capable of supporting at least 100 pounds. To reduce the risk of fire, electric shock or personal injury, mount to the outlet box marked acceptable for fan supported and use mounting screws provided with the outlet box. The box must be supported directly by the building structure.
- 6 **WARNING:** To reduce the risk of fire, electric shock or personal injury, mount to outlet box marked "acceptable for fan support" and use mounting screws provided with the outlet box most outlet boxes commonly used for the support of lighting fixtures are not acceptable for fan support and may need to be replaced. Consult a qualified electrician if in doubt.
- 7 Electrical diagrams are for reference only. Light kits that are not packed with the fan must be UL listed and are suitably marked with the designated fan model you are installing. Switches must be UL general use switches. Refer to the instructions packaged with the light kits and switches for proper assembly.
- 8 After installation is completed, check that all connections are absolutely secure.

- 9 After making electrical connections, spliced conductors should be turned upward and pushed carefully up into outlet box. The wires should be spread apart with the grounded conductor and the equipment-grounding conductor on one side of the outlet box.
- 10 **WARNING:** To reduce the risk of electrical shock and fire, do not use this fan with any solid-state fan speed control device, or rheostat.
- 11 Do not separate the reverse switch until the fan has come to a complete stop.
- 12 Do not insert anything into the fan blades while they are rotating.
- 13 **WARNING:** To reduce the risk of personal injury, do not bend the blade brackets (also referred to as “flanges”) during assembly or after installation. Do not insert objects in the path of the blades.
- 14 To avoid personal injury or damage to the fan and other items, be cautious when working around or cleaning the fan.
- 15 Do not use water or detergent when cleaning the fan or fan blades. A dry dust cloth or lightly dampened cloth will be suitable for most cleaning.
- 16 **WARNING:** Chemical Burn Hazard. Keep batteries away from children. This remote contains a lithium button cell battery. If a new or used lithium button/coin cell battery is swallowed or enters the body, it can cause severe internal burns and can lead to death in as little as 2 hours. Always completely secure the battery compartment. If the battery compartment is not closed securely, stop using the product, remove the batteries, and keep it away from children. If you think batteries might have been swallowed or placed inside any part of the body, seek immediate medical attention. Dispose batteries properly and keep away from children. Even used batteries may cause injury.

NOTE: The important safety precautions and instructions appearing in the manual are not meant to cover all possible conditions and situations that may occur. It must be understood that common sense and caution are necessary factors in the installation and operation of this fan.

NOTE: This product is not intended for use by people (including children) with reduced physical, sensory or mental capabilities are different or are impaired, or lack of experience or knowledge, unless such persons are supervised or trained to operate the appliance by a person responsible for their safety.

NOTE: Children should be supervised to ensure that they do not use appliances as a toy.

UNPACKING YOUR FAN

TOOLS REQUIRED

- Phillips screwdriver
- Blade screwdriver
- 11 mm wrench
- Step ladder
- Wire cutters

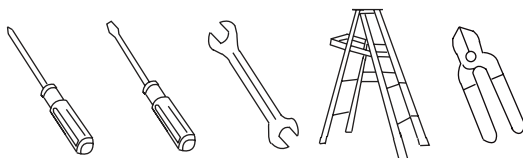

CONTAINS: Hanger bracket / Downrod / Canopy / Canopy Cover / Upper Blade Holder Ring System / Fan Motor Assembly / Blades x 3 / Receiver + Remote control incl. / Loose parts bag containing / Blade screw / Washer / Spring Washer / Screw nuts / Cable hardware (1pc per item) / Light Kit / Lampshade

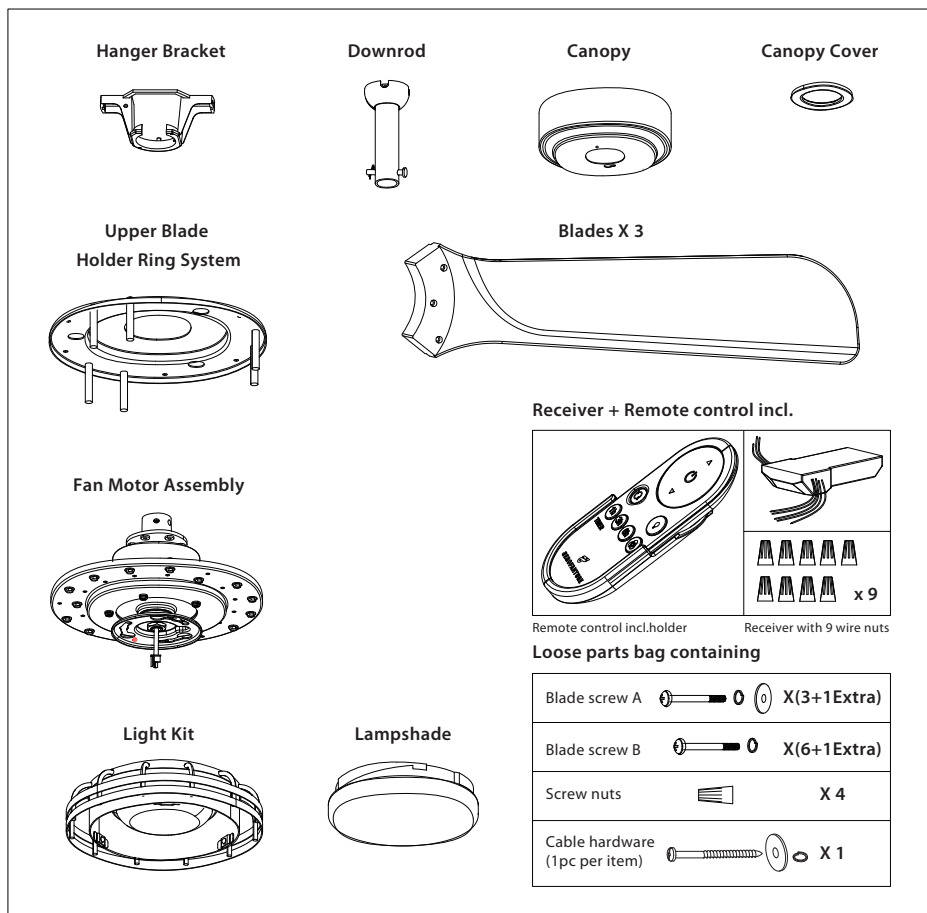

INSTALLING YOUR FAN

STEP.
01

Fig.1a

Turn Off Power Source

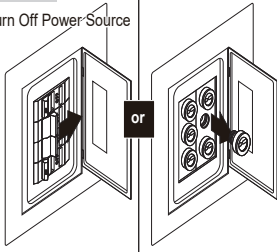
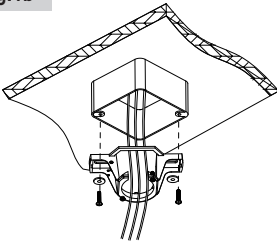

Fig.1b



REMEMBER to turn off the power. Follow the steps below to hang your fan properly:

Pass the 120-volt supply wires through the center hole in the ceiling hanger bracket as shown in Fig. 1b.

Secure the hanger bracket to the ceiling outlet box with the screws and washers provided with your outlet box.

STEP.
02

Fig.2

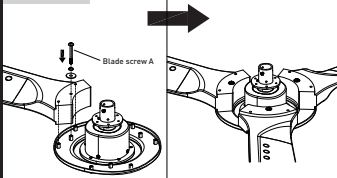

Attach the blades to fan motor assembly using screws, spring washers and washers as shown in Figure 2. Insert a screw, spring washer and washer into the blade's middle hole and fasten it. Repeat this step for the other remaining blades.

STEP.
03

Fig.3

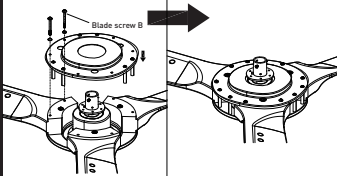

Attach the upper blade holder ring system as shown in Figure 3. Insert two screws and washers into another 2 holes of the blade and fasten them. Repeat these steps for the remaining blades.

STEP.
04

Fig.4

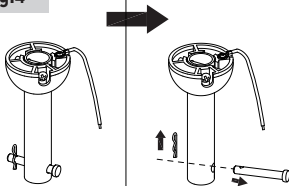

Remove the locking pin from the hanger bolt from the downrod, unlock the bolt. (shown as Fig. 4)

INSTALLING YOUR FAN

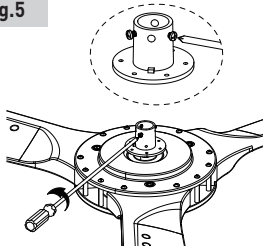
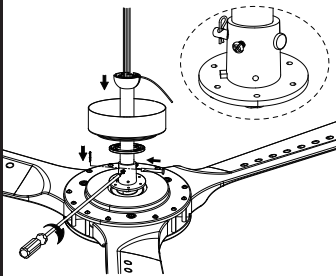
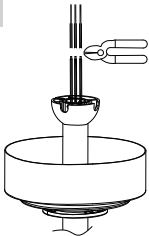
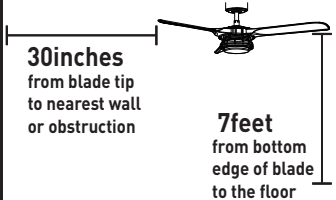
<p>STEP. 05</p>	<p>Fig.5</p> 	<p>Loosen the 2 screws on the adapter at the top of the motor assembly.</p>
<p>STEP. 06</p>	<p>Fig.6</p> 	<p>Route the wires out of the top of the fan motor through the adapter, canopy cover and canopy and then through the downrod.</p> <p>Align the holes on the downrod with the adapter and carefully insert the hanger bolt through the hole. Be careful not to jam the hanger bolt against the wiring inside the downrod. Insert the locking pin through the hole near the end of the hanger bolt until it snaps into its locked position, and tighten set screws as noted in the circle inset of Fig 6.</p>
<p>STEP. 07</p>	<p>Fig.7</p> 	<p>Cut off excess fixture wires leaving approximately the length that can be connected.</p>
<p>STEP. 08</p>	<p>Fig.8</p>  <p>30inches from blade tip to nearest wall or obstruction</p> <p>7feet from bottom edge of blade to the floor</p>	<p>CAUTION: To reduce the risk of injury, install the fan so that the blades are at least 7 ft. (2.1m) above the floor (Figure 8).</p> <p>WARNING: To avoid possible electrical shock, be sure electricity is turned off at the main fuse box or circuit breaker panel before wiring.</p> <p>NOTE: If you are not sure if the outlet box is grounded, contact a licensed electrician for advice, as it must be grounded for safe operation.</p> <p>WARNING: To avoid fire or shock, follow all wiring instructions carefully. Any electrical work not described in these instructions should be done or approved by a licensed electrician.</p>

INSTALLING YOUR FAN

STEP.
09

Fig.9

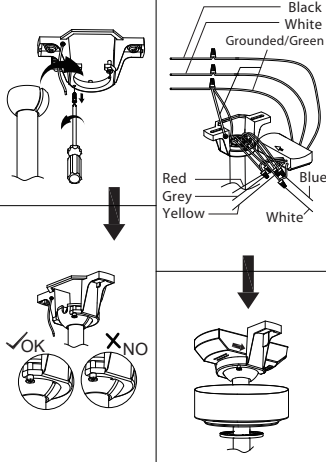

Release 1 screw of the hanger bracket socket.
Place the downrod ball into the hanger bracket socket. Make sure the hanger ball is seated in the groove on the hanger bracket.

Rotate fan until notch on downrod ball engages the ridge on the mounting bracket.

After hanging fan onto the mounting bracket, make sure plug connectors from the ceiling fan and terminal block away from the space located above the downrod ball. Slide the remote receiver into the space above the downrod ball as shown.

STEP.
10

Fig.10

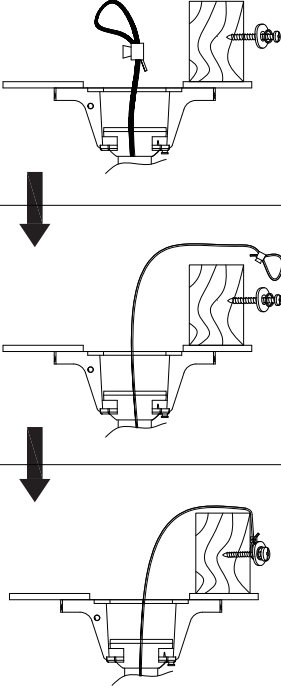

Drive a wood screw and washers into the side of the brace that holds the outlet box.

Insert the safety cable through the hanger bracket and also insert one of the holes in the outlet box into the ceiling. Adjust the length of the safety cable to reach the screw and washers by pulling the extra cable through the cable clamp until the overall length is correct, put the end of the cable back through the cable clamp, forming a loop at the end of the cable.

Tighten the cable clamp securely. Now, put the loop in the end of the safety cable over the wood screw and under the washer. Tighten the wood screw securely.

INSTALLING YOUR FAN

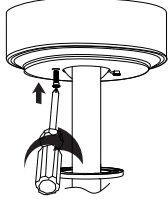
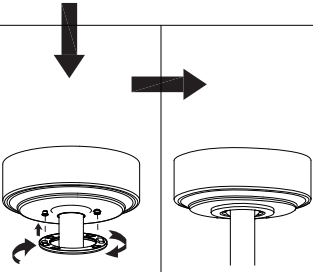
STEP. 11	<p>Fig.11</p> 	<p>Attach the canopy up to mounting bracket and align the screw hole with the canopy. Secure it by tightening the two set screws.</p> <p>Slide the canopy cover up to the canopy, turn canopy cover until it locks at the end of the circular holes.(Fig. 11)</p> <p>NOTE: Adjust the canopy screws as necessary until the canopy and canopy cover are snug.</p>
		

INSTALLING YOUR FAN

STEP.
12

Fig.12

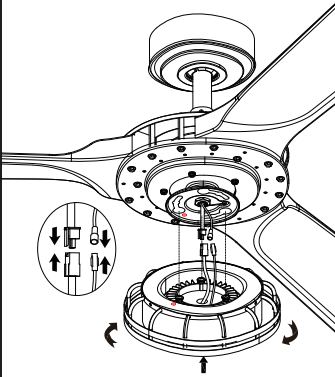

Hold the light kit close to the switch housing and securely attach the 2-pin connectors.

Tuck the connectors neatly into the light kit. Align three round holes on the light kit and switch housing. Securely tighten with 3 links (Fig.12)

Plug connectors from the downrod and the light kit. Hold the light kit close to the mounting bracket and align the 3 screws on the thermal module with the large hole of the circular hole on the mounting bracket. Turn and tuck the light kit neatly into the mounting bracket until the 3 screws lock at the end of the circular holes. (Fig.12)

STEP.
13

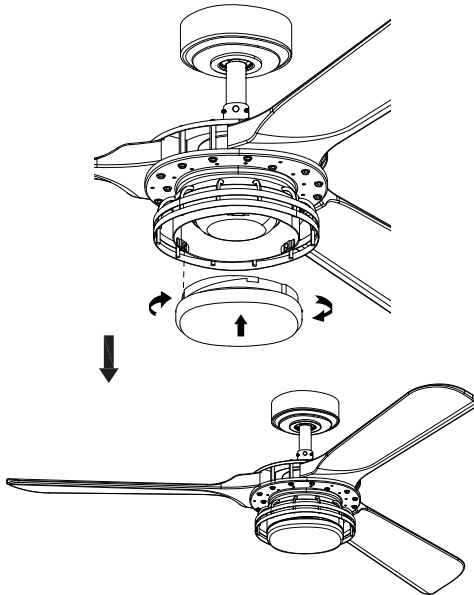
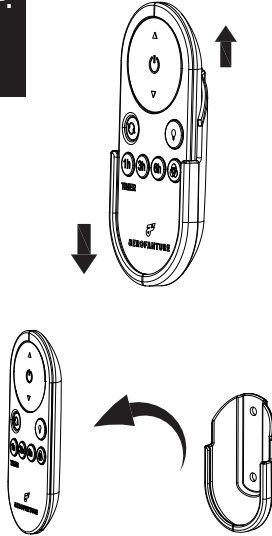
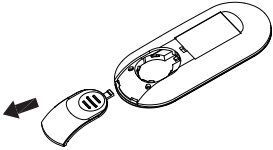
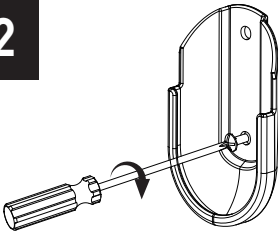

Fig.13



Secure the lampshade to the switch housing by twisting in a counterclockwise direction. Do not over-tighten(Fig.13).

OPERATING YOUR REMOTE CONTROL

Installing the Remote Control : FOLLOW STEP 01-06

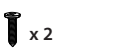
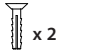
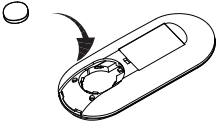
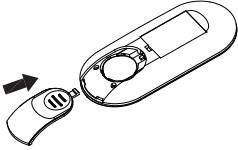
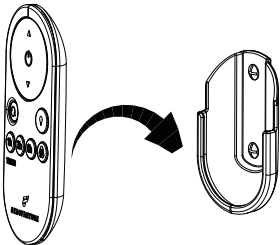
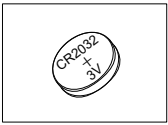
<p>STEP. 01</p> 	<p>STEP. 03</p> 
<p>STEP. 02</p>    	<p>STEP. 04</p> 
<p>STEP. 05</p> 	<p>STEP. 06</p>  

Restore power to ceiling fan and test for proper operation.

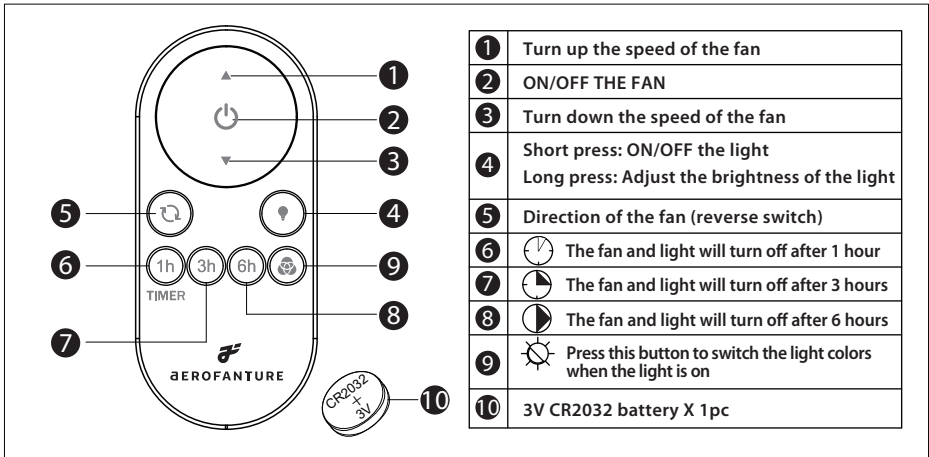

AFTER INSTALLATION

“WOBBLE”

The fan blades have been adjusted in the factory to minimize any wobble

NOTE: CEILING FANS TEND TO MOVE DURING OPERATION DUE TO THE FACT THAT THEY ARE MOUNTED ON A RUBBER CROMMET. IF THE FAN WAS MOUNTED RIGIDLY TO THE CEILING, IT WOULD CAUSE EXCESS VIBRATION. MOVEMENT OF A FEW CENTIMETERS IS QUITE ACCEPTABLE AND DOES NOT SUGGEST ANY PROBLEM

TO REDUCE THE FAN WOBBLE: PLEASE CHECK THAT ALL SCREWS WHICH SECURED THE MOUNTING BRACKET AND DOWNROD ARE SECURE.

BALANCING A WOBBLING CEILING FAN:

For your convenience, a Balancing Kit is included; please follow this procedure when balancing the fan:

- 1 Check that all blade and blade arm screws are secure.
- 2 Most fan wobbling problems are caused when blade levels are unequal. Check this level by selecting a point on the ceiling above the tip of one of the blades. Measure this distance. Rotate the fan until the next blade is positioned for same measurement. Repeat for each blade. The distance deviation should be equal within 1/8"(0.32cm).

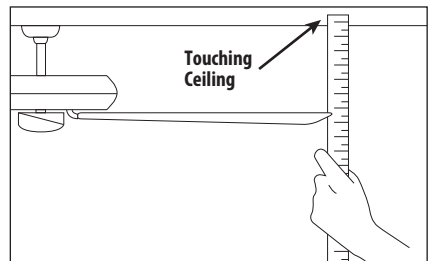

- ③ Use the enclosed Blade Balancing Kit if the blade wobble is still noticeable.
- ④ If the blade wobble is still noticeable, interchanging two adjacent (side by side) blades can redistribute the weight and possibly result in smoother operation.

WARNING: TO REDUCE THE RISK OF PERSONAL INJURY, DO NOT BEND THE BLADE ARM WHILE INSTALLING, BALANCING THE BLADES, OR CLEANING THE FAN. DO NOT INSERT FOREIGN OBJECTS BETWEEN ROTATING FAN BLADES.

NOISE

When it is quiet (especially at night) you may hear occasional small noises. This is normal. Please allow a 24- hour “breaking-in” period, most noises associated with a new fan disappear during the time.

CARE AND CLEANING

- ① Periodic cleaning of your ceiling fan is the only maintenance required. Use a soft brush or lint free cloth to avoid scratching the paint finish. Please make sure to turn off electricity power before you clean your fan.
- ② Do not use water when cleaning your ceiling fan. It could damage the motor or the blades and create the possibility of an electrical shock.
- ③ Motor has permanently lubricated ball bearing. No need to oil.

NOTE: MAKE SURE THE POWER IS OFF AT THE ELECTRICAL PANEL BOX BEFORE YOU ATTEMPT ANY CLEANING OR REPAIRS.



AEROFANTURE

SWITCH

Ceiling Fan
Installation Manual

