

**iScooter****USER GUIDE  
ELECTRIC SCOOTER  
FOR KIDS****iK2**

The manufacturer reserves the right to make changes to the product, and update this manual at any time.

Customer service for support :

🌐 [www.iscooterglobal.co.uk](http://www.iscooterglobal.co.uk)

✉ Email Service: [support@iscooterglobal.co.uk](mailto:support@iscooterglobal.co.uk)

**Read and understand this entire manual before allowing children to use this product!**

# Contents

1.Safety Instructions	01
2. Package Contents	02
3.Product Overview	04
4.Before Riding	05
5.Start Riding	07
6.Charging	08
7.Riding Notice	09
8.Specifications	11
9.Daily Care and Maintenance	12
10. Contact Us	13



## Safety Instructions



### **AN IMPORTANT MESSAGE TO PARENTS:**

This manual contains important information. For your child's safety, it is your responsibility to review this information with your child and make sure that your child understands all warnings, cautions, instructions, and safety topics. All children and preteens should ride under adults' guidance at all times. It is recommended that you periodically review and reinforce the information in this manual with younger riders and that you are required to inspect and maintain your child's e-scooter to ensure their safety.



### **GENERAL WARNING:**

Riding an electric scooter is a sport and entertainment tool for children. There may be dangers in the process of riding, such as losing control and falling. Therefore, safety precautions should be taken before riding and the risks of this sport should be explained to your child. It has the property of a vehicle, so it also has the safety risk of all vehicles. In countries or regions like China, there are no such electric scooter related national standards and regulations, please be sure to strictly abide by the safety requirements of this manual for riders. We will not assume any direct or joint liability for all property, personal losses, accidents, legal disputes, and other adverse events that cause conflicts of interest caused by violations of the use behaviors suggested in this manual.

1. This product is an electric scooter for children. No passengers are allowed. Do not carry others.
2. A helmet and other protective equipment are required when riding this product.
3. Do not ride this product in unsafe or illegal places.
4. Please practice in the open space and avoid riding on the traffic lanes first. Only ride after mastering skilled riding.
5. Do not perform dangerous actions or ride with one hand while riding. Keep your feet on the scooter.
6. Do not try to directly pass stairs higher than 3cm, as it may overturn the e-scooter, causing injury to riders or damage to the e-scooter. Steps lower than 3 cm should also be avoided as far as possible.
7. The maximum speed of the scooter is 8km/h. For your riding safety, please try to avoid using it at night.
8. Do not use this product in an environment below - 5℃.
9. In case of uneven or poor road conditions, please ride slowly or get off the e-scooter.
10. Do not ride this product on terrain with oil or ice on the surface.







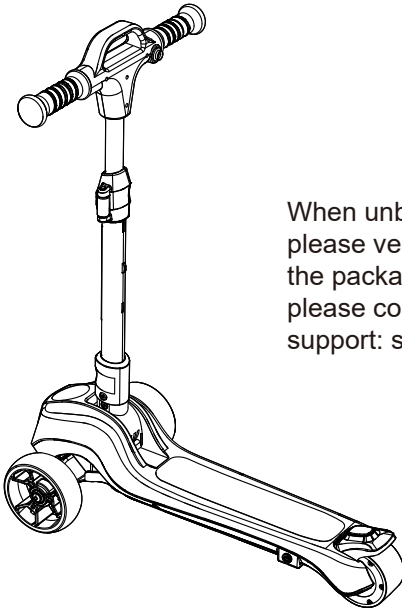

11. When riding, please adjust the handlebar of the product to an appropriate position according to your kid's height to ensure riding safety.
12. Do not immerse the product in water deeper than 3cm or directly spray water on the e-scooter body to avoid the impact of water on the scooter's electrical system.
13. In bad weather such as rain, snow, and strong wind, please try to avoid riding to avoid danger.

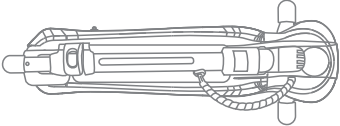
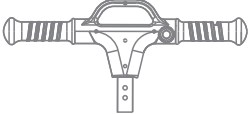
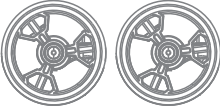
**⚠ WARNING: ALWAYS INSPECT THE E-SCOOTER BEFORE RIDING.** Properly inspecting and maintaining the e-scooter can reduce the risk of injury. Always inspect it before riding and regularly maintain it. Check and secure all fasteners before every ride. Replace worn or broken parts immediately. Ride with caution since skills are required to avoid falls or collisions that may cause injury to riders or third parties.

## Package Contents

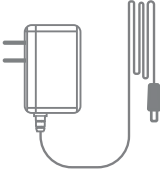

When unboxing your iK2 electric kids scooter, please verify that the below items are included in the package. If anything is missing or damaged, please contact iScooter customer service for support: [support@iscooterglobal.co.uk](mailto:support@iscooterglobal.co.uk).

NO.	Name	Picture	Quantity
1	kids scooter		1
2	Handlebar		1
3	Front Wheel		2
4	Front Axle Bolt		2
5	Front Axle Nut		2
6	Screws		6
7	Hex Key		2
8	Charger		1
9	Manual		1
10	Brand Card		1
11	Sticker		4



## Product Overview

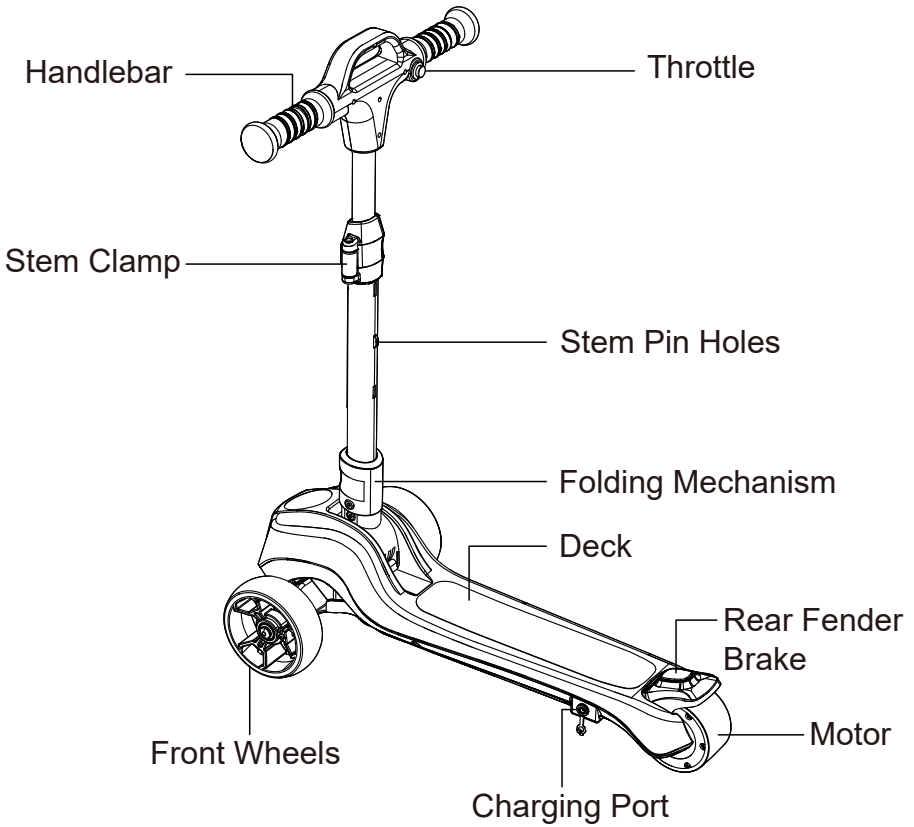



## Before Riding

### Assemble the electric kids scooter

#### Warning

Before riding, please check whether the stem lock is tightened, if you don't fasten it correctly, you may lose control or fall. If you don't know how to tighten the lock, please contact us.

#### 1. Remove the plastic protective covers



Remove the plastic covers on the front axles and stem.

#### 2. Install the front wheels



2.1 Put the nuts into the slots under the front axles.



2.2 Pass the front axle bolts through the front wheel hubs and nuts, and then tighten the bolts with a hex key.

### 3. Unfold/fold the stem



#### 3.1 To unfold

While pulling the folding mechanism in the direction of the arrow, raise the stem until it is vertical to the deck and clicks into place.



#### 3.2 To fold

While pulling the folding mechanism in the direction of the arrow, lower the stem down towards the deck until it clicks into place.

### 4. Install the handlebar

Connect the wires correctly and then tighten the 4 screws with a hex key.



### 5. Adjust the handlebar height

Open the stem clamp lever. Press in the stem pin and raise or lower the handlebar until the pin clicks into another stem pin hole.







## Start Riding

### Start the e-scooter

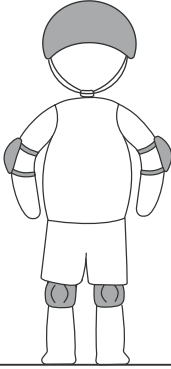

1. Wear helmets and knee pads in case of falls and injuries when you start riding the electric kids scooter, as shown in the figure.

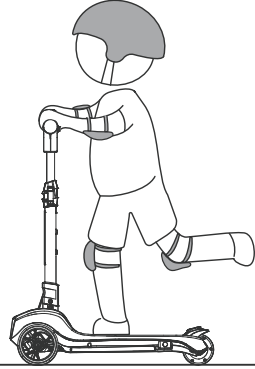

2. Hold both ends of the handlebar with both hands. Place the weak leg on the e-scooter and kick off with the other from the ground to make the e-scooter move forward.

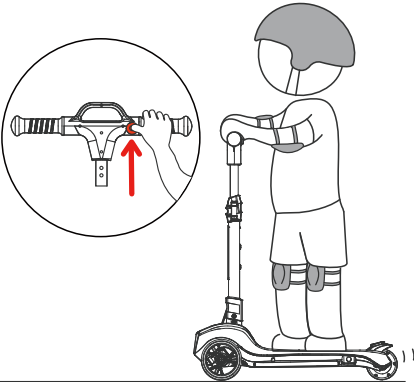

3. When the e-scooter is moving forward, place the other foot on the deck. After both feet are stable, gently press the thumb throttle.

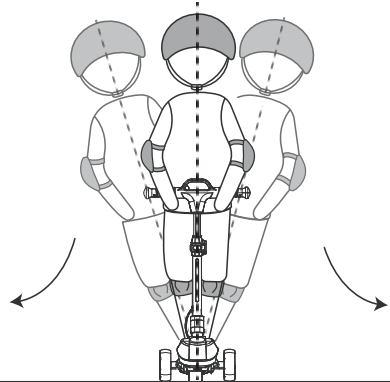

4. When turning, tilt the body's center of gravity slightly toward the turning direction and slowly turn the handlebar.

## Stop the e-scooter

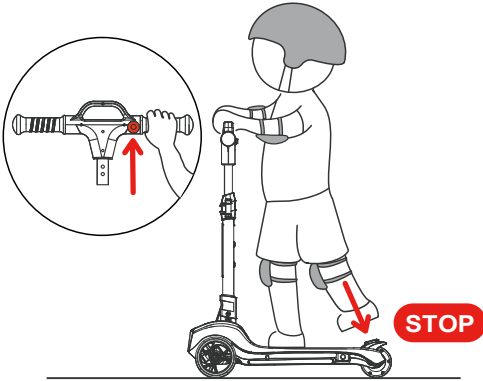

5. To stop the scooter, release the throttle first, and then step on the rear fender brake.

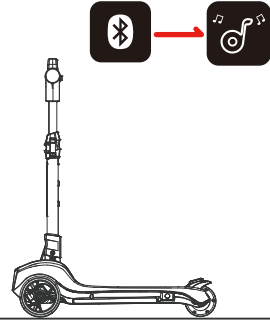

6. Also, it allows you to connect it to your phone via Bluetooth to play music.

## Charging

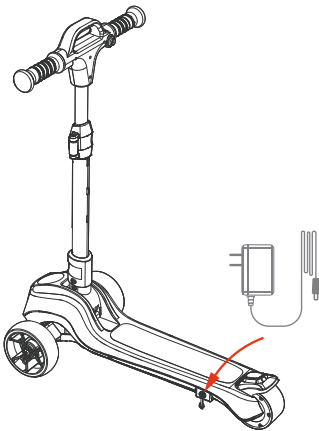

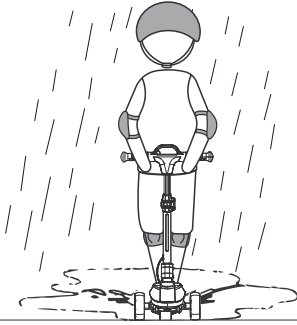

- Your scooter will be fully charged when the LED light on the charger changes to green from red.
- The scooter has charging protection and charging will cut off automatically after fully charge.
- Even so, we still don't recommend charging your scooter for a long time more than 24 hours at one time.
- Do not connect the charger if the charging port is wet.
- Keep the charging port closed when not charging.

# Riding Notice

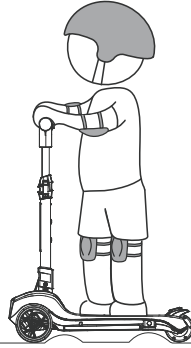

 Please avoid riding in the rain.



 Please slow down and pass unconventional roads slowly such as speed bumps, elevator door sills, and potholes.

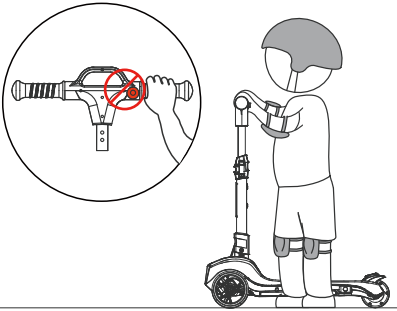

 When walking the electric scooter, please don't press the thumb throttle.

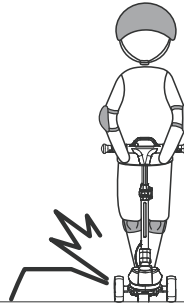

 Please avoid obstacles.

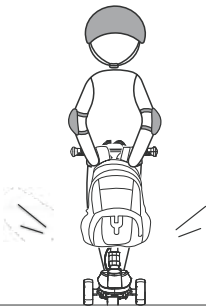

 Please don't hang heavy objects such as backpacks on the handlebar.



 Please don't accelerate when going down hill.

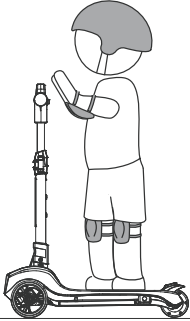

 It is forbidden to ride with hands off the handlebar.

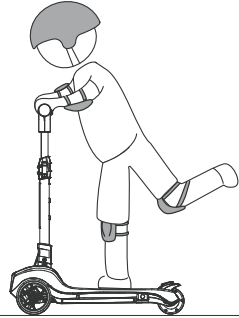

 When riding, keep both feet on the deck. Do not perform dangerous stunts with one foot off the deck.

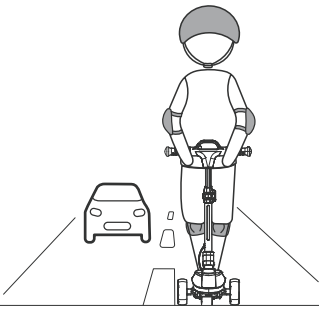

 It is forbidden to ride into motor vehicle lanes or residential quarters mixed with people and vehicles.

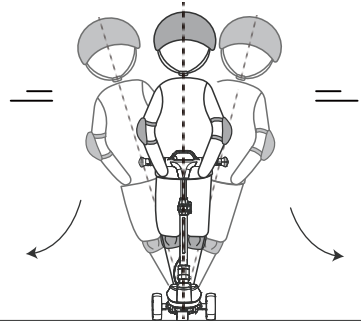

 It is forbidden to turn the handlebar sharply while riding.

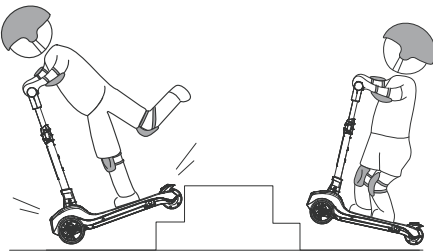

 It is forbidden to ride up or down steps or jump obstacles.



 No passengers (including infants) are allowed.



## Specifications

Item category	Project	Value
Dimensions	Unfolded (L x W x H)	60.5×28.2×82.5 CM
	Folded (L. x W x H)	60.5×28.2×16.8 CM
Weight	Net Weight	8.8LBS/4KG
	Gross weight	12.1LBS/5.5KG
Riding requirements	Maximum load	110LBS/50KG
	Applicable age	3+
Scooter	Top speed	4.9mph/8km/h
	Range	30-60min
Battery	Rated voltage	18V
	Rated capacity	2.0Ah
Motor	Power	70W
Charger	Rated input voltage	AC100-240V
	Rated output voltage	21V
	Rated current	0.5A
	Charging time	4-5H



## Daily Care and Maintenance

### E-scooter cleaning and storage:

- If the surface of the electric scooter body is contaminated, use a soft cloth dampened with a small amount of clean water to wipe it.
- For stains that are hard to clean, you can apply a toothbrush with toothpaste and brush repeatedly. Then wipe it with a damp cloth.
- If the plastic parts of the e-scooter body are scratched, they can be polished with sandpaper or other abrasive materials. (Tips: Do not use alcohol, gasoline, kerosene, or other corrosive and volatile chemical solvents for cleaning. Otherwise, the appearance and internal structure of the electric scooter will be seriously damaged.)
- It is forbidden to use a pressure washer to wash the e-scooter.
- Before cleaning, make sure that the electric scooter is turned off, the charging cable has been unplugged, and the rubber cover of the charging port has been closed tightly. Otherwise, it may lead to an electric shock or severe failure due to internal water inflow.
- When not in use, the electric scooter should be stored indoors in a dry and cool place as much as possible.
- Try to avoid storing it outdoors for a long time. Sun exposure, overheating, and low temperature will accelerate appearance and tire aging and reduce the service life and the battery pack.

### Battery Maintenance

1. Do not use battery packs of other models or brands, otherwise, there may be safety risks.
2. Do not touch the battery contacts and do not disassemble or puncture the casing. Touching battery contacts with metal objects will result in short circuits, battery damage, or casualties.
3. Only use the original charger for charging. Otherwise, there is a danger of damage or fire.
4. Improper disposal of used batteries may seriously pollute the environment. Please comply with local regulations when discarding the battery pack. Please don't discard this battery pack at will to jointly protect the natural environment.
5. Please fully charge the battery and then store it after each use, which is beneficial to prolong the battery life.

Do not place the battery pack in temperatures higher than 50 °C or lower than -20 °C (for example, do not put an electric scooter or its battery pack in a car exposed to the sun in summer). Do not put the battery pack into the fire which may cause the battery to fail, overheat, or even risk fire. When the electric scooter is not in use for more than 30 days, please fully charge it first, store it in a cool and dry place, and then fully charge it every 60 days. Otherwise, it may damage the battery. In this case, the battery is not covered by the warranty.

Avoid recharging when the battery is completely exhausted and try to use it after each riding as far as possible, which can greatly prolong the service life of the battery. In addition, when used at room temperature, the battery pack can provide a longer range and high performance; however, if used in an environment below 0 °C, the battery life and performance will decrease. Typically, in a 20 °C environment, the range may be only half or shorter than that at normal temperature. When the temperature rises, the range will restore.

**Tips:** A fully charged electric scooter will exhaust its stored power after about 120-180 days of standby. There is a smart chip inside the battery to record the charging and discharging situation of the battery. If the battery hasn't been charged for a long time, it will not be able to get recharged normally. Thus, if the battery is not charged in time, it will probably over-discharge and get permanent damage. This kind of damage is not covered by the warranty. (Note: Non-professionals are forbidden to disassemble the battery pack at will, otherwise serious safety accidents may occur due to electric shock or short circuits!)

## **Contact Us**

Contact us if you experience issues relating to riding, maintenance and safety, or errors/faults with your iScooter iK2 electric kids scooter .

✉ E-mail Service: [support@iscooterglobal.co.uk](mailto:support@iscooterglobal.co.uk).  [www.iscooterglobal.co.uk](http://www.iscooterglobal.co.uk)