

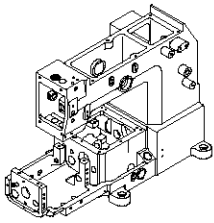

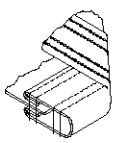

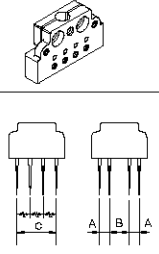





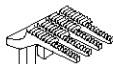
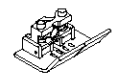





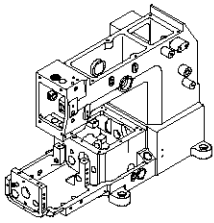
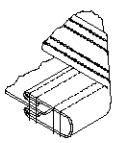
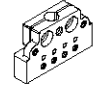
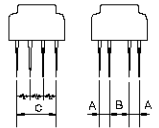

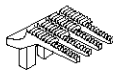
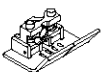





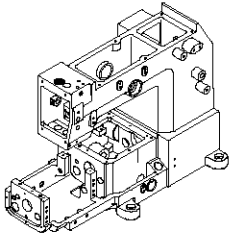
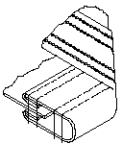

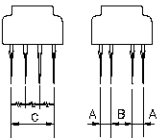

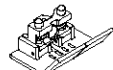



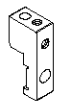

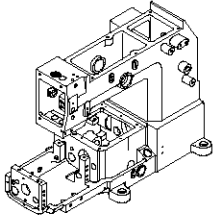
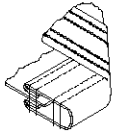
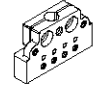
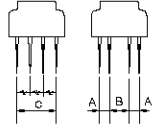

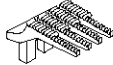
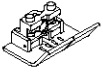

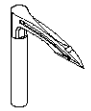

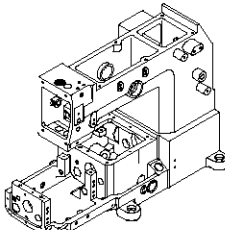
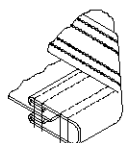
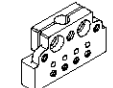
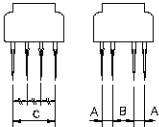

SIRUBA GAGE PARTS LIST		Series					Remark						Page	Date									
		VC008					*VPT:適用於VC008-1200X *VSF:適用於VC008-0448/0464 *VWL:適用於VC008-0400X						1 / 6	2013/05/13									
																							
機 型 MODEL	規格 SVB CLASS	種 類 NEEDLE GAUGE	針 座 NEEDLE HOLDER		針板 NEEDLE PLATE	送具 FEED DOG	押 具 PRESSER FOOT	撥線軸 RETAINER HOLDER	勾 針 LOOPER	護針片 NEEDLE GUARD	勾針座 LOOPER HOLDER	勾針座台 LOOPER HOLDER BLOCK	針 號 NEEDLE										
VC008-02/VMR	064P	1/4"	M9002		E9002D	D9002	P9002	R9002	VE51	VE49	L9002	VE11Q	UOX113GS #11~#14										
VC008-04	064P	3/4"	M9004		E9004D	D9004	P9004	R9004	VE51	VE49	L9004	VE11Q	UOX113GS #11~#14										
	085P	1"	M9104		E9104D	D9104	P9104	R9104	VE51	VE49	L9104	VE11Q	UOX113GS #11~#14										
	095P	1 1/8"	M9204		E9204D	D9204	P9204	R9204	VE51	VE49	L9204	VE11Q	UOX113GS #11~#14										
	106P	1 1/4"	M9304		E9304D	D9304	P9304	R9304	VE51	VE49	L9304	VE11Q	UOX113GS #11~#14										
	127P	1 1/2"	M9404		E9404D	D9404	P9404	R9404	VE51	VE49	L9404	VE11Q	UOX113GS #11~#14										
VC008-04/VUT	064P	3/4"	M9004		E9004D	D9004P	P9004	VUT109P	VE51	VE49	L9004	VE11Q	UOX113GS #11~#14										
	085P	1"	M9104		E9104D	D9104P	P9104	VUT109P	VE51	VE49	L9104	VE11Q	UOX113GS #11~#14										
	095P	1 1/8"	M9204		E9204D	D9204P	P9204	VUT109P	VE51	VE49	L9204	VE11Q	UOX113GS #11~#14										
	106P	1 1/4"	M9304		E9304D	D9304P	P9304	VUT109P	VE51	VE49	L9304	VE11Q	UOX113GS #11~#14										

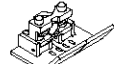
SIRUBA GAGE PARTS LIST		Series				Remark							Page	Date
		VC008				*VPT:適用於VC008-1200X *VSF:適用於VC008-0448/0464 *VWL:適用於VC008-0400X							2 / 6	2013/05/13
														
機 型 MODEL	規格 SVB CLASS	種 類 NEEDLE GAUGE	針 座 NEEDLE HOLDER	針 板 NEEDLE PLATE	送 具 FEED DOG	押 具 PRESSER FOOT	撥 線 軸 RETAINER HOLDER	勾 針 LOOPER	護 針 片 NEEDLE GUARD	勾 針 座 LOOPER HOLDER	勾 針 座 台 LOOPER HOLDER BLOCK	針 號 NEEDLE		
VC008-04/VUT	127P	1 1/2"	M9404	E9404D	D9404P	P9404	VUT109P	VE51	VE49	L9404	VE11Q	UOX113GS #11~#14		
VC008-04A	64P	1/4"	M9213	E9213	D9213	P9213D	R9213	VE51	VE49	L9002	VE11Q	UOX113GS*4 #11~#14		
VC008-04A32	032P	(1/4-1/8-1/8 1/4)*3	M9113	E9113	D9113	P9113D	R9113	VE51T	VE49T	L9119T-E	VE11Q	UOX113GS #11~#14		
VC008-0448	191P	3/16-3/4-3/16"	M9504A	E9504E	D9504A	P9504A	R9504A	VE51	VE49	L9504A	VE11Q	UOX113GS #11~#14		
	222P	3/16-7/8-3/16"	M9204A	E9204E	D9204A	P9204A	R9204A	VE51	VE49	L9204A	VE11Q	UOX113GS #11~#14		
	254P	3/16-1-3/16"	M9404A	E9404E	D9404A	P9404A	R9404A	VE51	VE49	L9404A	VE11Q	UOX113GS #11~#14		
VC008-0448 /VSF	254P	3/16-1-3/16"	M9404A	E9404E	D9404A	P9404A	R9404A	VE51	VE49	L9404A	VE11Q	UOX113GS #11~#14		
VC008-0464	191P	1/4-3/4-1/4"	M9304A	E9304E	D9304A	P9304A	R9304A	VE51	VE49	L9304A	VE11Q	UOX113GS #11~#14		
	127P	1/4-1/2-1/4"	M9004A	E9004E	D9004A	P9004A	R9004A	VE51	VE49	L9004A	VE11Q	UOX113GS #11~#14		
	254P	1/4-1-1/4"	M9104A	E9104E	D9104A	P9104A	R9104A	VE51	VE49	L9104A	VE11Q	UOX113GS #11~#14		
VC008-06/VPL	048P	3/16"	M9012	E9012	D9012	P9412D	R9012	VE51	VE49	L9012	VE11Q	UOX113GS #11~#14		

SIRUBA GAGE PARTS LIST		Series				Remark							Page	Date
		VC008				*VPT:適用於VC008-12XXX applicable to VC008-12XXX *VSF:適用於VC008-0448/0464 applicable to VC008-0448/0464 *VWL:適用於VC008-04XXX applicable to VC008-04XXX							3 / 6	2013/06/22
														
機 型 MODEL	規格 SVB CLASS	種 類 NEEDLE GAUGE	針 座 NEEDLE HOLDER		針板 NEEDLE PLATE	送 具 FEED DOG	押 具 PRESSER FOOT	撥線軸 RETAINER HOLDER	勾 針 LOOPER	護針片 NEEDLE GUARD	勾針座 LOOPER HOLDER	勾針座台 LOOPER HOLDER BLOCK	針 號 NEEDLE	
VC008-06/VPL	064P	1/4"	M9112		E9112	D9112	P9512D	R9112	VE51	VE49	L9112	VE11Q	UOX113GS #11~#14	
VC008-06/VPL	064P	1/2"	M9112		E9112	D9112	P9512B	R9112	VE51	VE49	L9112	VE11Q	UOX113GS #11~#14	
VC008-06/VUT	064P	1/4"	M9112		E9112	D9112	P9112D	VUT109P	VE51	VE49	L9112	VE11Q	UOX113GS #11~#14	
VC008-06	048P	3/16"	M9012		E9012	D9012	P9412D	R9012	VE51	VE49	L9012	VE11Q	UOX113GS #11~#14	
VC008-08/VUT	064P	1/4"	M9108		E9108	D9108	P9108	VUT109P	VE51	VE49	L9112	VE11Q	UOX113GS #11~#14	
VC008-1132	064P	1/8-1/4-1/8"	M9313		E9211	D9211JK	P9211-A P9211A-A	R9313	VE51T	VE49T	L9113T-E	VE11Q	UOX113GS #11~#14	
VC008-12	048P	3/16"	M9012		E9012	D9012	P9012D	R9012	VE51	VE49	L9012	VE11Q	UOX113GS #11~#14	
	050P	5mm	M9612		E9612	D9612	P9612D	R9612	VE51	VE49	L9612	VE11Q	UOX113GS #11~#14	
VC008-12/VPQ	064P	1/4"	M9112		E9112	D9112	P9112D	R9112	VE51	VE49	L9112	VE11Q	UOX113GS #11~#14	
	048P	3/16"	M9012		E9312	D9312	P9312	R9012	VE51Q	VE49	L9012	VE11Q	UOX113GS #11~#14	
	048P	3/16"	M9012		E9212	D9212	P9212	R9012	VE51Q	VE49	L9012	VE11Q	UOX113GS #11~#14	

SIRUBA GAGE PARTS LIST		Series			Remark								Page	Date
		VC008			*VPT:適用於VC008-1200X *VSF:適用於VC008-0448/0464 *VWL:適用於VC008-0400X								4 / 6	2013/05/13
														
機 型 MODEL	規格 SVB CLASS	種 類 NEEDLE GAUGE	針 座 NEEDLE HOLDER	針板 NEEDLE PLATE	送 具 FEED DOG	押 具 PRESSER FOOT	撥線軸 RETAINER HOLDER	勾 針 LOOPER	護針片 NEEDLE GUARD	勾針座 LOOPER HOLDER	勾針座台 LOOPER HOLDER BLOCK	針 號 NEEDLE		
VC008-12/VPQK	064P	1/4"	M9112	E9312	D9312	P9312	R9112	VE51Q	VE49	L9112	VE11Q	UOX113GS #11~#14		
VC008-12/VPQK	048P	3/16"	M9012	E9212	D9212	P9212	R9012	VE51Q	VE49	L9012	VE11Q	UOX113GS #11~#14		
VC008-12/VPS	048P	3/16"	M9012	E9212A	D9212	P9212B	————	VSM47	————	L9012	VE11Q	DV-K25 #18~#21		
	064P	1/4"	M9112	E9312A	D9312	P9312B	————	VSM47	————	L9112	VE11Q	DV-K25 #18~#21		
VC008-12/VPL	064P	1/4"	M9112	E9112	D9112	P9712D	R9112	VE51	VE49	L9112	VE11Q	UOX113GS #11~#14		
VC008-12/VPT	048P	3/16"	M9012	E9012	D9012	P9012D	R9012	VE51	VE49	L9012	VE11Q	UOX113GS #11~#14		
	064P	1/4"	M9112	E9112	D9112	P9112D	R9112	VE51	VE49	L9112	VE11Q	UOX113GS #11~#14		
VC008-12/VSM	048P	3/16"	M9012	E9012	D9012	P9012B P9212B	R9012	VE51	VE49	L9012	VE11Q	DVX57 #11~#18		
	064P	1/4"	M9112	E9112	D9112	P9112B P9312B	R9112	VE51	VE49	L9112	VE11Q	DVX57 #11~#18		
VC008-12/VSQ	048P	3/16"	M9012	E9212A	D9212	P9212B	————	VSM47	VE49	L9012	VE11Q	DV-K25 #18		
	064P	1/4"	M9112	E9312A	D9312	P9312B	————	VSM47	VE49	L9112	VE11Q	DV-K25 #18		

SIRUBA GAGE PARTS LIST		Series				Remark							Page	Date
		VC008				*VPT:適用於VC008-12XXX applicable to VC008-12XXX *VSF:適用於VC008-0448/0464 applicable to VC008-0448/0464 *VWL:適用於VC008-04XXX applicable to VC008-04XXX							5 / 6	2013/06/04
			 											
機 型 MODEL	規格 SVB CLASS	種 類 NEEDLE GAUGE	針 座 NEEDLE HOLDER		針板 NEEDLE PLATE	送 具 FEED DOG	押 具 PRESSER FOOT	撥線軸 RETAINER HOLDER	勾 針 LOOPER	護針片 NEEDLE GUARD	勾針座 LOOPER HOLDER	勾針座台 LOOPER HOLDER BLOCK	針 號 NEEDLE	
VC008-12/VSSM	048P	3/16"	M9012		E9212	D9212	P9212B	R9012	VE51Q	VE49	L9012	VE11Q	DVX57 #11~#18	
VC008-12/VSSM	064P	1/4"	M9112		E9312	D9312	P9312B	R9112	VE51Q	VE49	L9112	VE11Q	DVX57 #11~#18	
VC008-12/VUT	050P	5mm	M9612		E9612	D9612P	P9612D	VUT109P	VE51	VE49	L9612	VE11Q	UOX113GS #11~#14	
VC008-12/VSC	064P	1/4"	M9112		E9112E	D9112E	P9112D	R9112	VE51	VE49	L9112	VE11Q	UOX113GS #11~#14	
VC008-12A32	032P	(1/4-1/8-1/8 1/4)*3	M9113		E9113	D9113	P9113D	R9113	VE51T	VE49T	L9119T-E	VE11Q	UOX113GS #11~#14	
VC008-12A	64P	1/4"	M9213		E9213	D9213	P9213D	R9213	VE51	VE49	L9002	VE11Q	UOX113GS*6 #11~#14	
VC008-13	032P	1/8"	M9313		E9313	D9313	P9313	R9313	VE51T	VE49T	L9113T-E	VE11Q	UOX113GS*4 #11~#14	
	064P	1/4"	M9213		E9213	D9213	P9213D	R9213	VE51	VE49	L9213	VE11Q	UOX113GS*4 #11~#14	
VC008-1332	032P	(1/4-1/8-1/8 1/4)*3	M9113		E9113	D9113	P9113D	R9113	VE51T	VE49T	L9119T-E	VE11Q	UOX113GS*4 #11~#14	
VC008-17	032P	1/8"	M9117		E9117A	D9117A	P9117	R9117	VE51T	VE49T	L9119T-E	VE11Q	UOX113GS*4 #11~#14	
VC008-21	032P	1/8"	M9121		E9121B	D9121A	P9121	R9121	VE51T	VE49T	L9123T-E	VE11Q	UOX113GS*4 #11~#14	

SIRUBA GAGE PARTS LIST		Series		Remark									Page	Date
		VC008		*VPT:適用於VC008-1200X applicable to VC008-1200X *VSF:適用於VC008-0448/0464 applicable to VC008-0448/0464 *VWL:適用於VC008-0400X applicable to VC008-0400X									6 / 6	2013/05/13
機 型 MODEL	規格 SVB CLASS	種 類 NEEDLE GAUGE	針 座 NEEDLE HOLDER		針板 NEEDLE PLATE	送 具 FEED DOG	押 具 PRESSER FOOT	撥線軸 RETAINER HOLDER	勾 針 LOOPER	護針片 NEEDLE GUARD	勾針座 LOOPER HOLDER	勾針座台 LOOPER HOLDER BLOCK	針 號 NEEDLE	
VC008-23	032P	1/8"	M9123		E9123A	D9123A	P9123	R9123	VE51T	VE49T	L9123T-E	VE11Q	U0X113GS*4 #11~#14	

SIRUBA PARTS LIST	Series	Parts Group	Subclass / Remark	Page
	VC008	VA		1/1
				Date
				2013/08/13

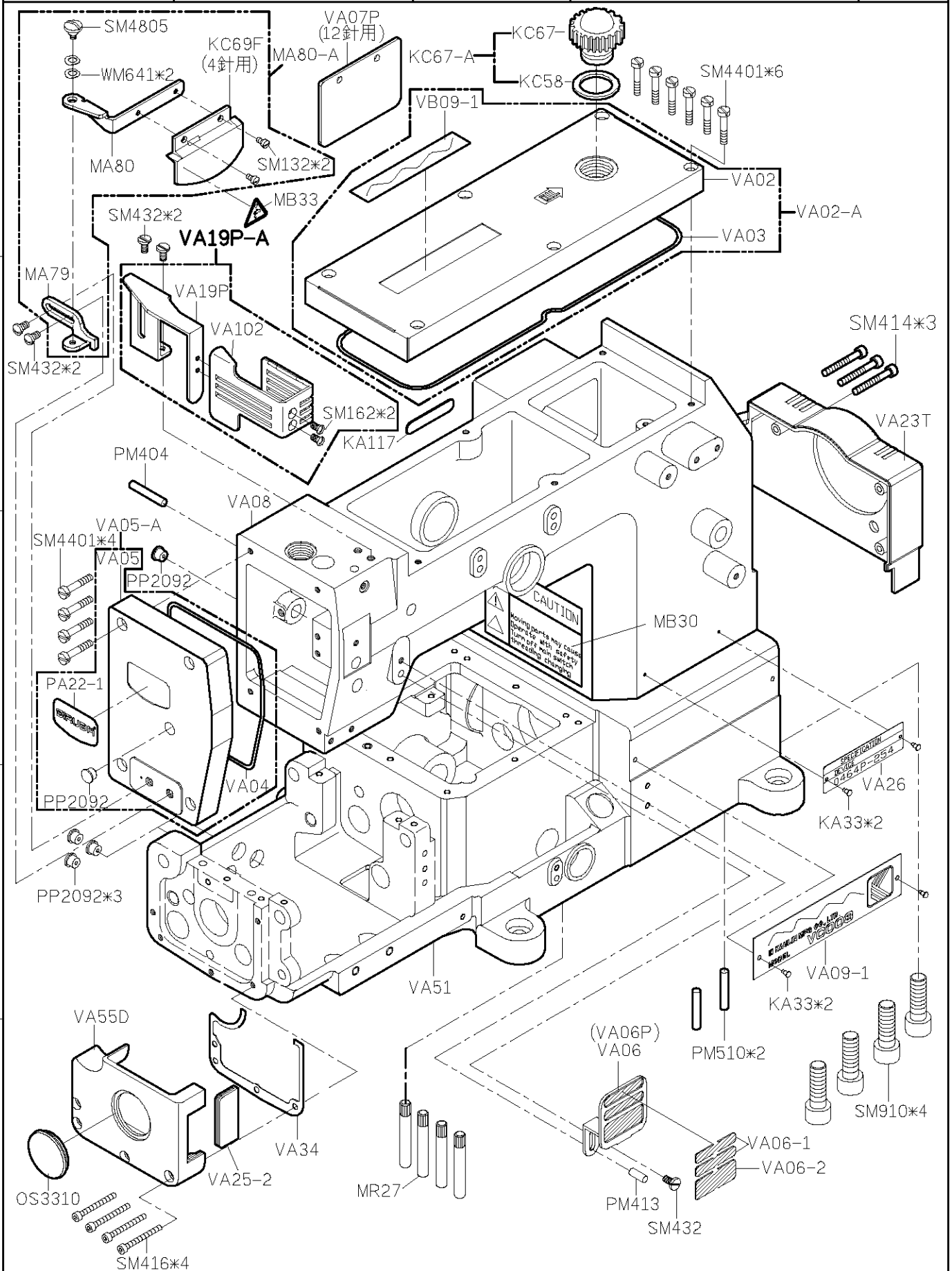

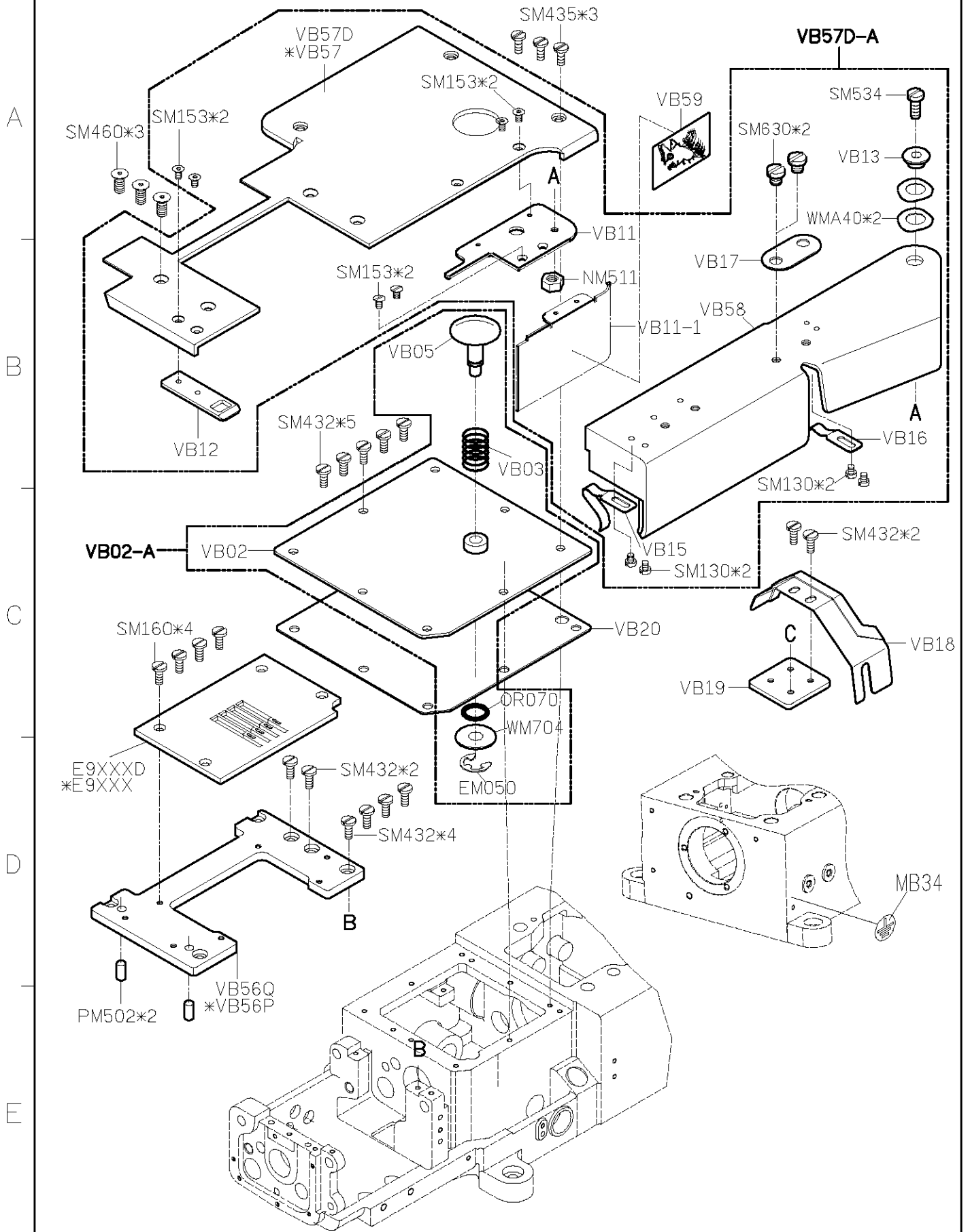

SIRUBA PARTS LIST	Series	Parts Group	Subclass / Remark	Page
	VC008	VC		1/1
				Date
				2012/09/23

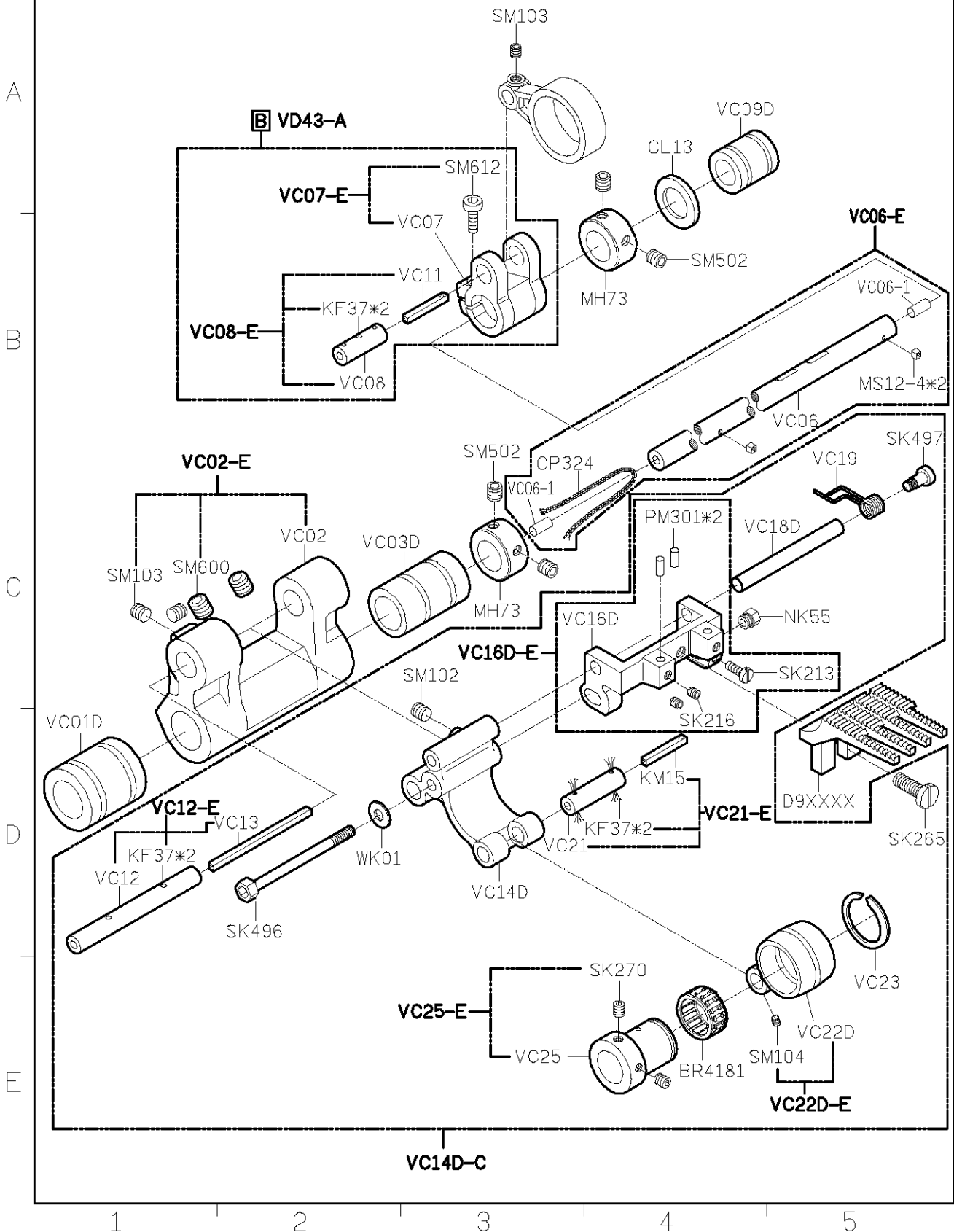

SIRUBA PARTS LIST	Series	Parts Group	Subclass / Remark	Page
	VC008	VD		1/1
				Date
				2015/11/02

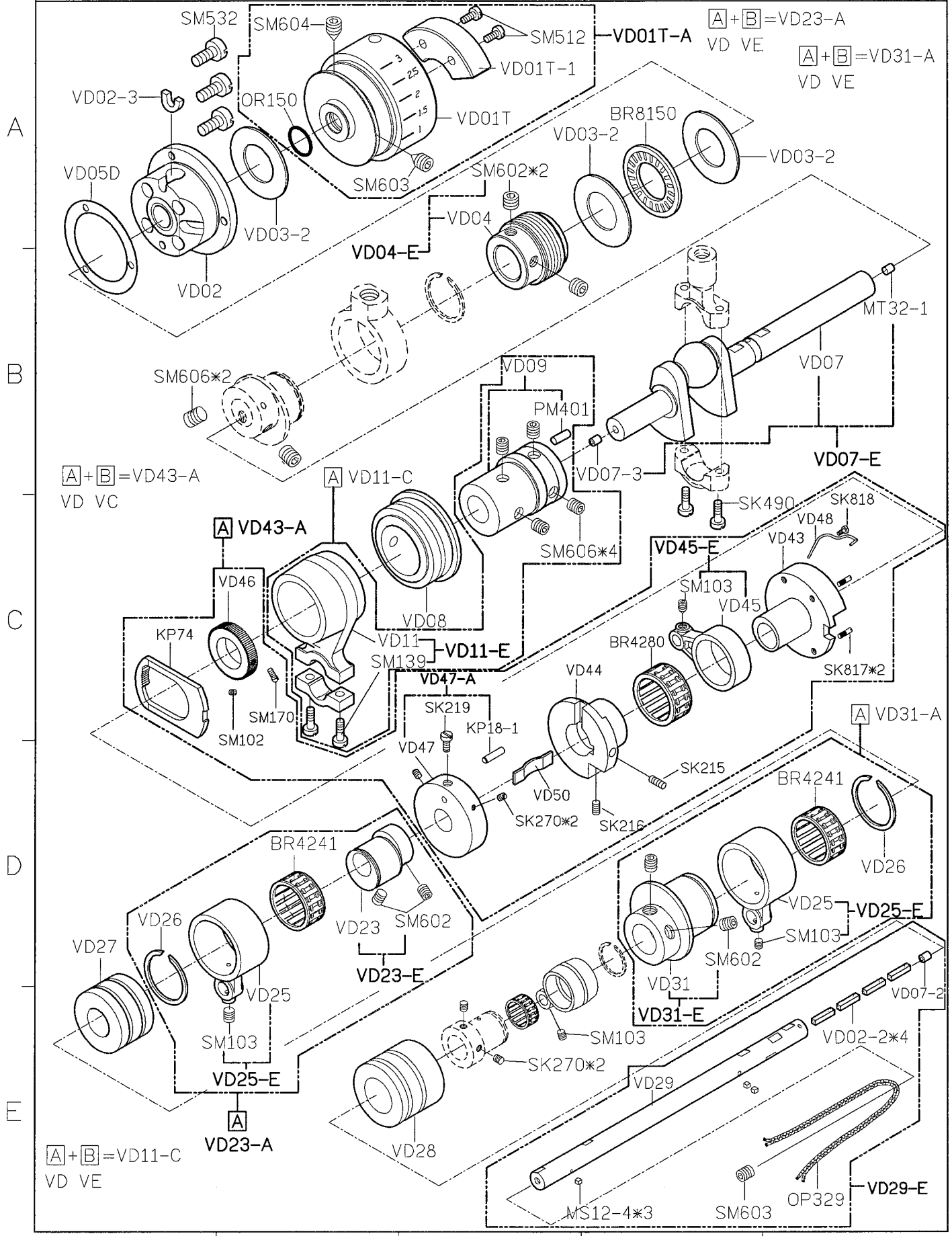

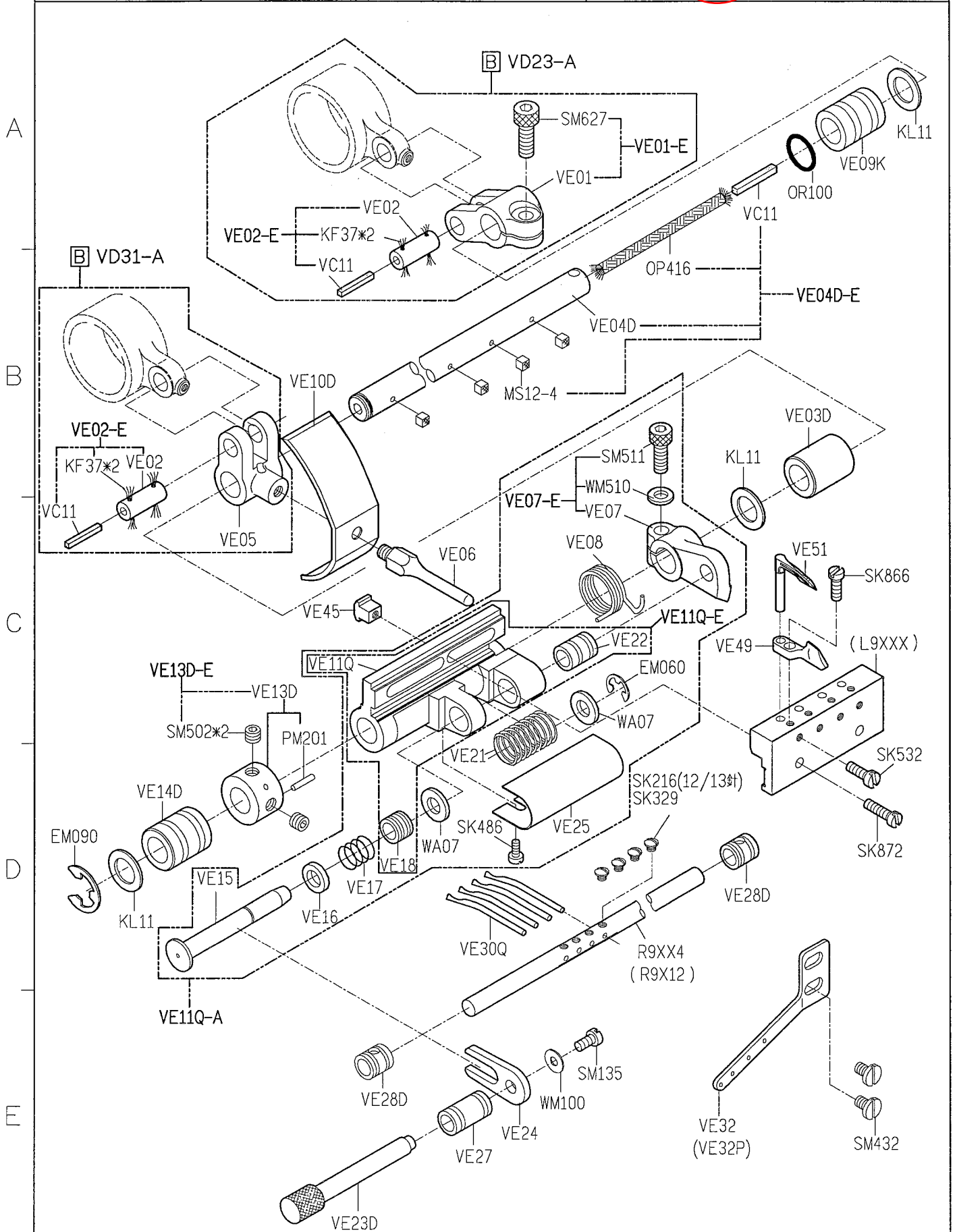

SIRUBA PARTS LIST	Series	Parts Group	Subclass / Remark	Page
	VC008	VE		2/4
				Date
				2012/09/23

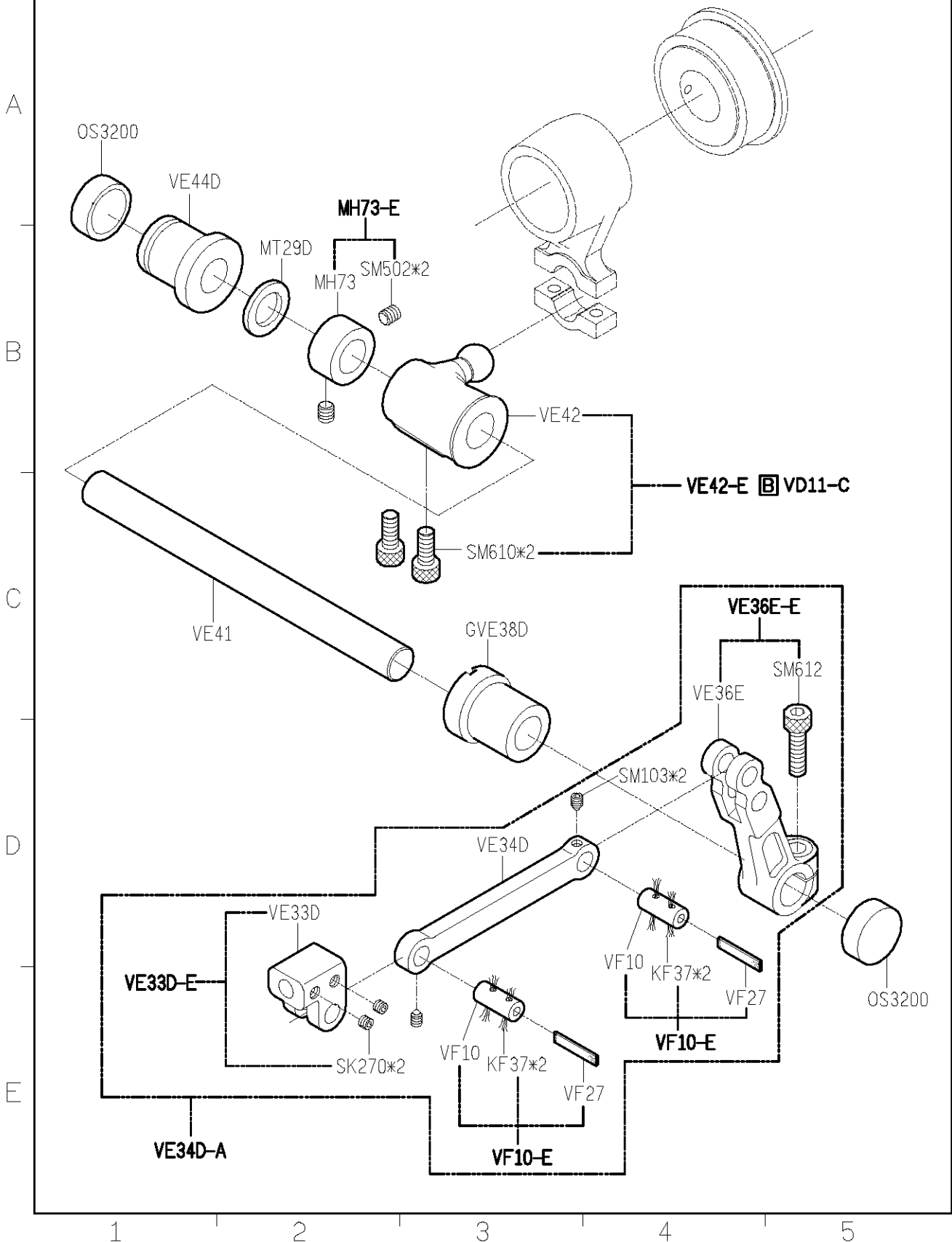

FOR 13~25 NEEDLE

A

B

C

D

E

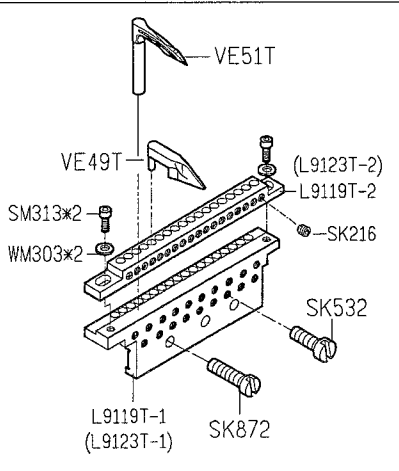
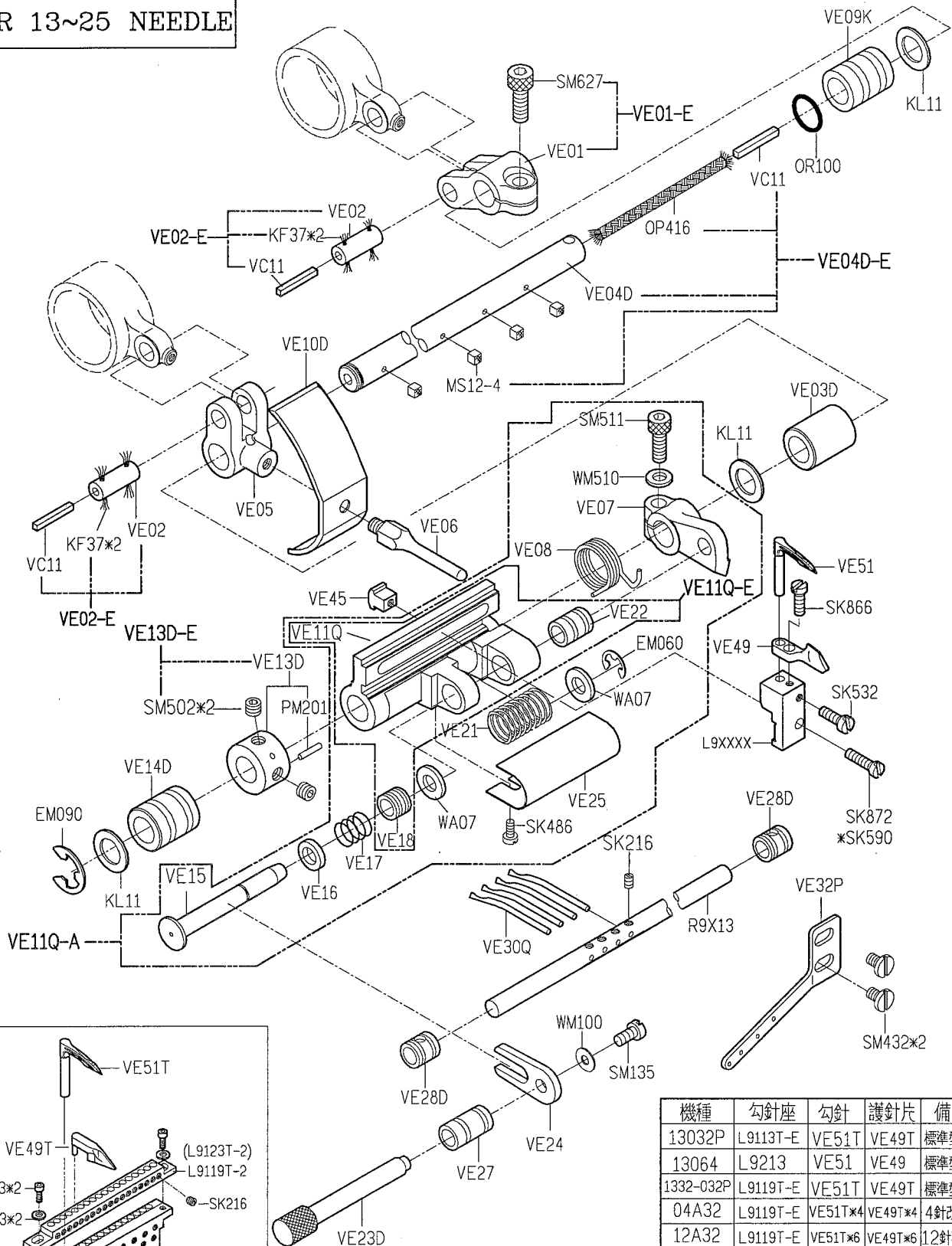

機種	勾針座	勾針	護針片	備註
13032P	L9113T-E	VE51T	VE49T	標準型13針
13064	L9213	VE51	VE49	標準型13針
1332-032P	L9119T-E	VE51T	VE49T	標準型13針
04A32	L9119T-E	VE51T*4	VE49T*4	4針改13針
12A32	L9119T-E	VE51T*6	VE49T*6	12針改13針
04A64	L9002*4	VE51*4	VE49*4	4針改13針
12A64	L9002*6	VE51*6	VE49*6	12針改13針
17032P	L9119T-E	VE51T	VE49T	標準型17針
21032P	L9123T-E	VE51T	VE49T	標準型21針
23032P	L9123T-E	VE51T	VE49T	標準型23針
25032P	L9125T-E	VE51T	VE49T	標準型25針

1 2 3 4 5

SIRUBA PARTS LIST	Series	Parts Group	Subclass / Remark	Page
	VC008	VE		4/4
				Date
				2012/08/23

FOR 13~25 NEEDLE

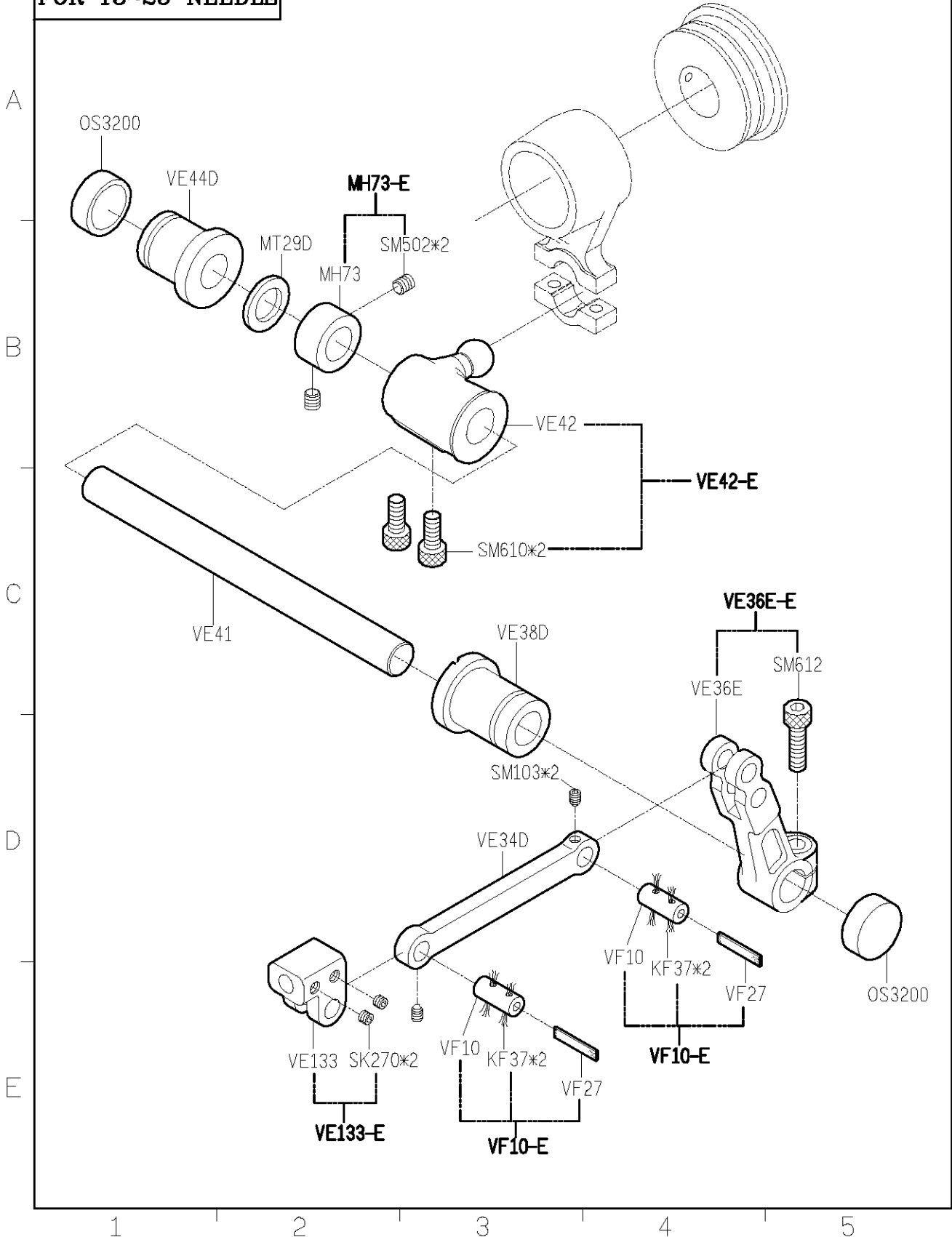

SIRUBA PARTS LIST	Series	Parts Group	Subclass / Remark	Page
	VC008	VF		1/1
				Date
				2013/12/16

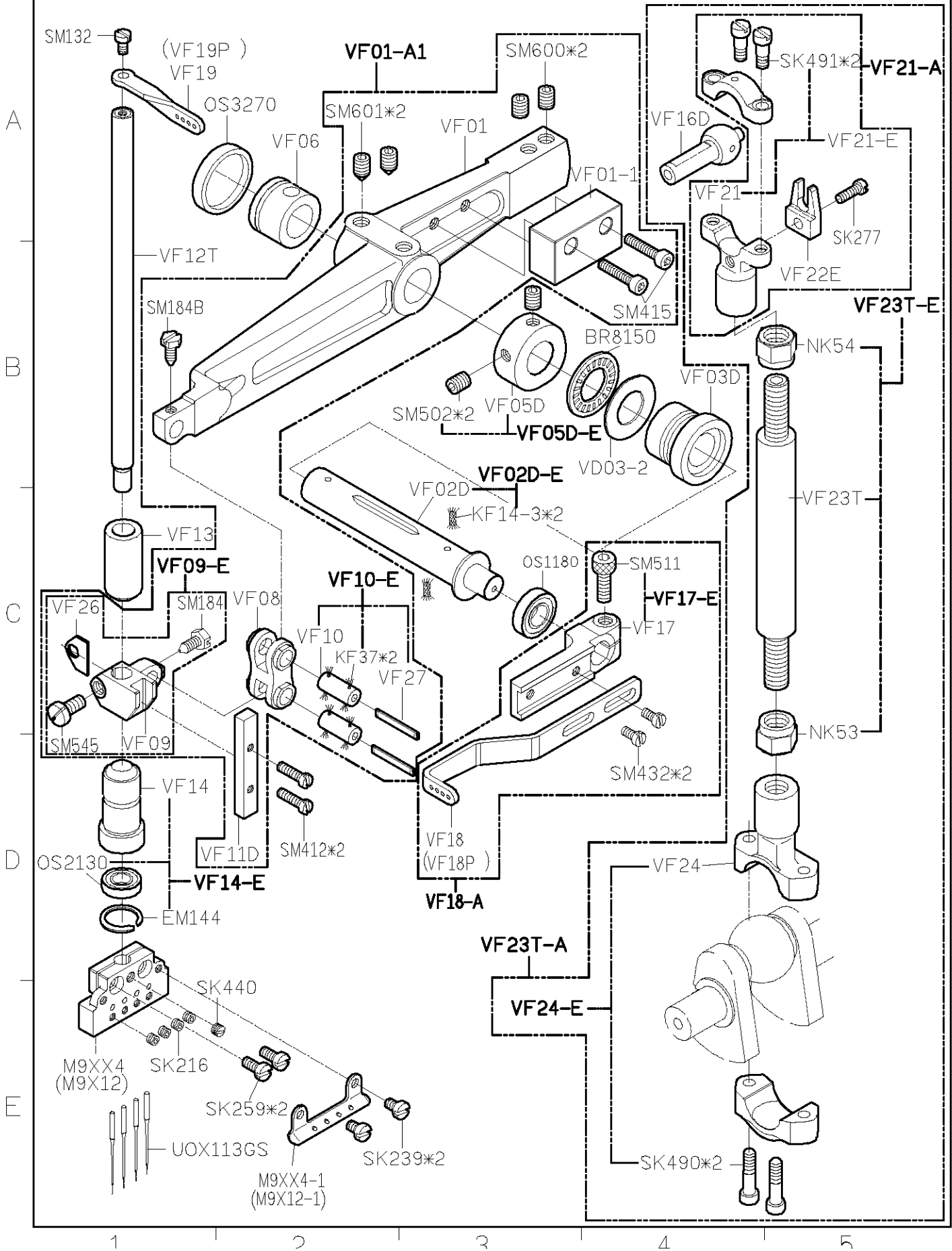

SIRUBA PARTS LIST	Series	Parts Group	Subclass / Remark	Page
	VC008	VJ	# Use for VUT	1/1
				Date
				2012/08/23

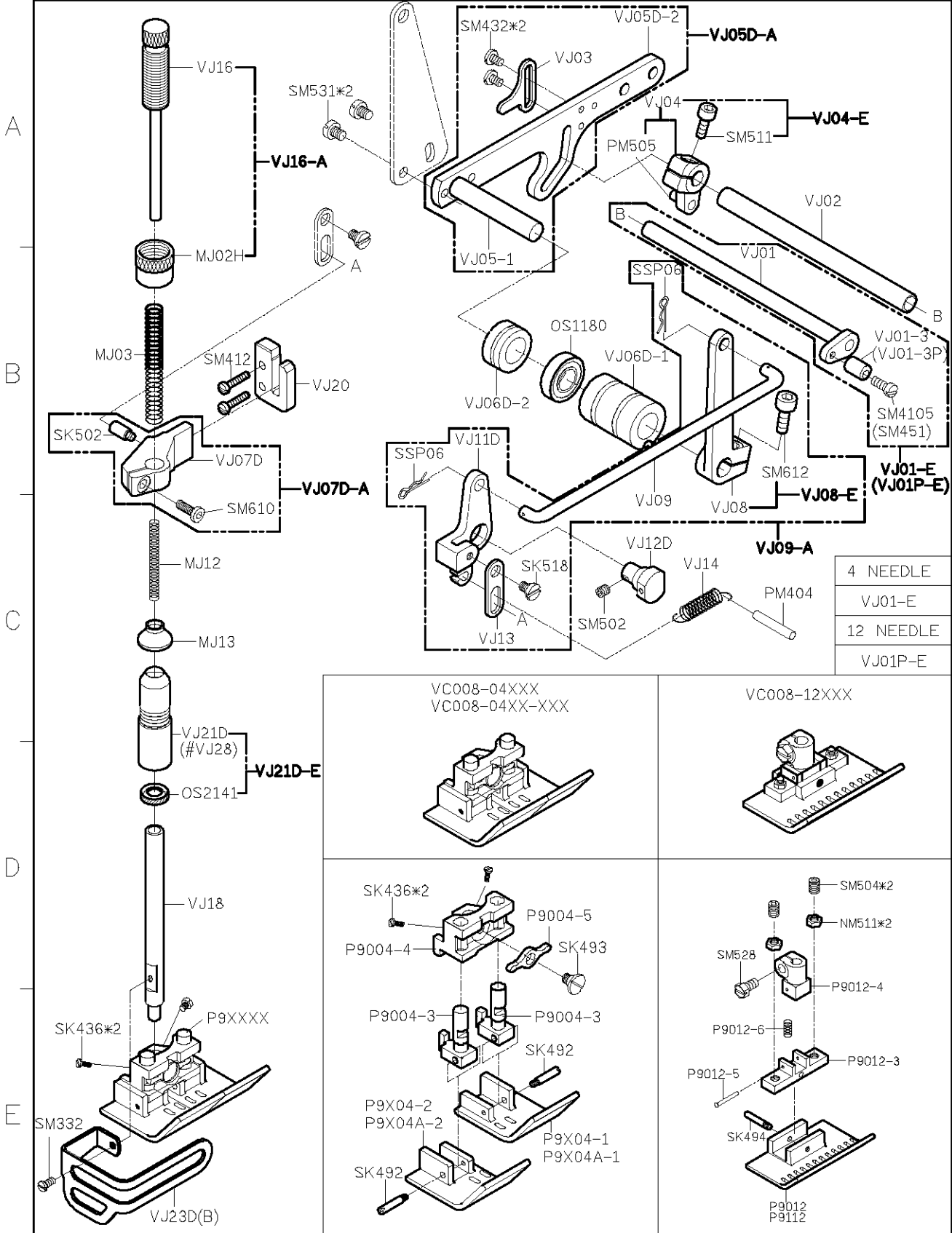

SIRUBA PARTS LIST	Series	Parts Group	Subclass / Remark	Page
	VC008	VK		1/2
				Date
				2015/08/05

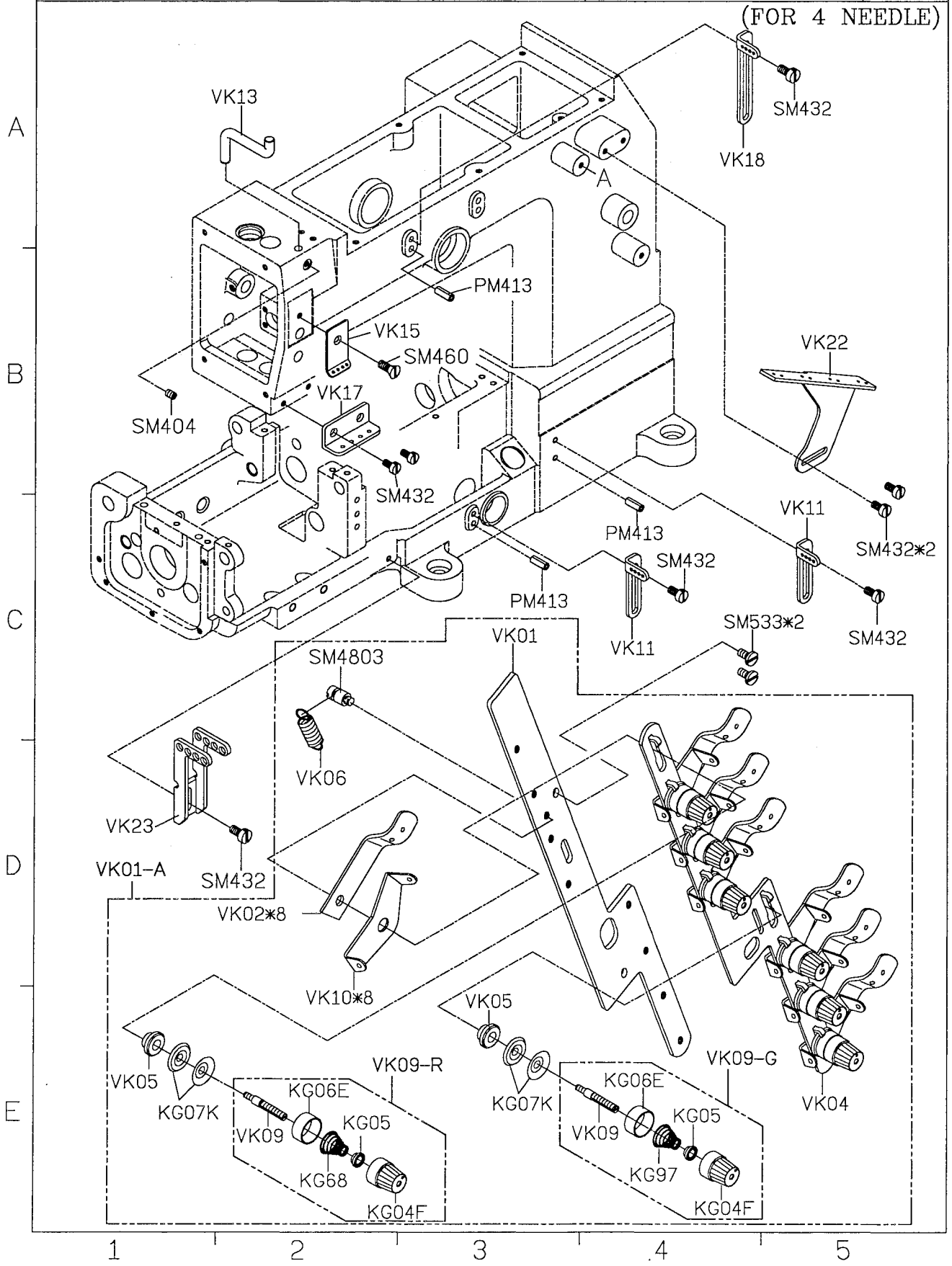

SIRUBA PARTS LIST	Series	Parts Group	Subclass / Remark	Page
	VC008	VK		2/2
				Date
				2015/08/05

(FOR 12 NEEDLE)

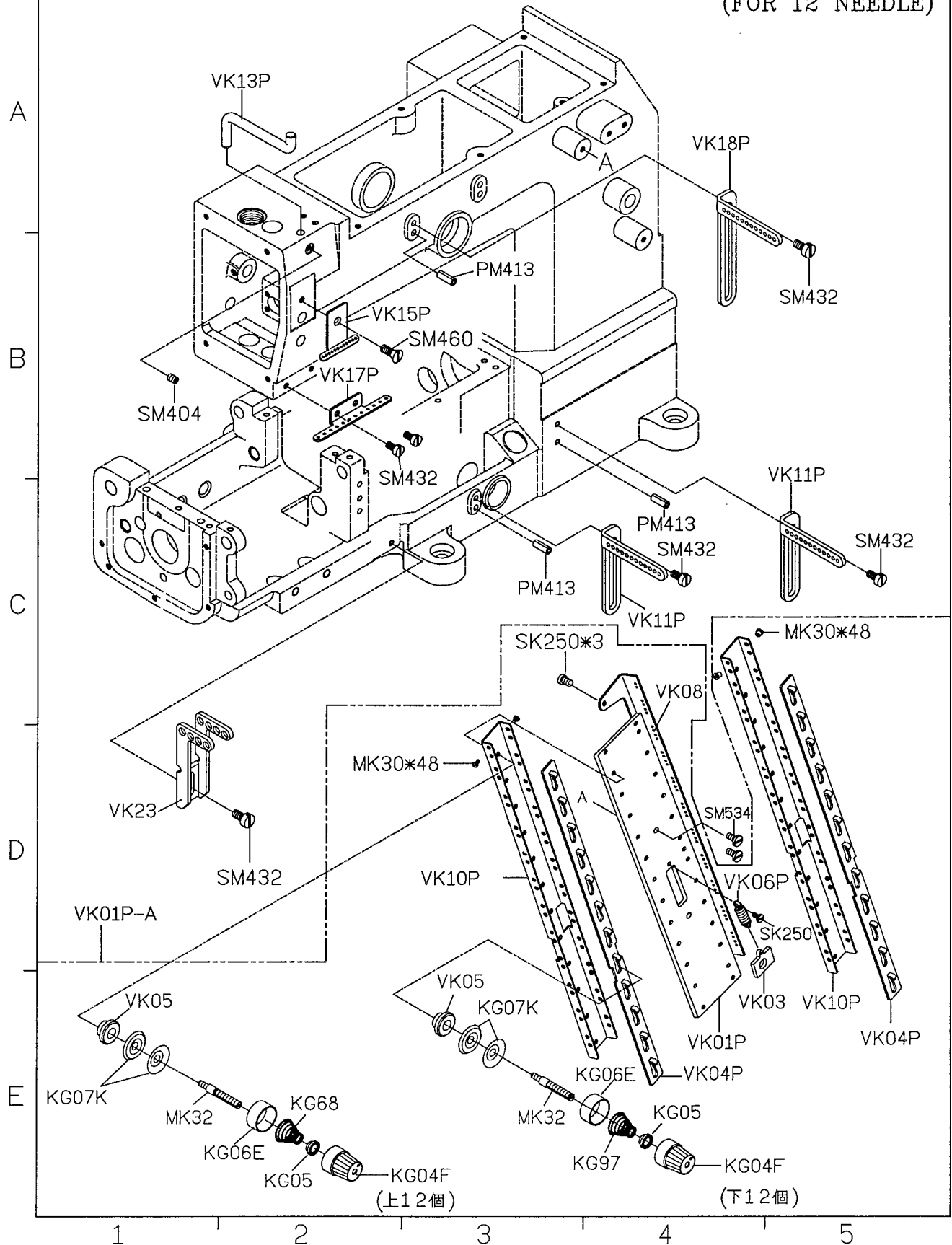

SIRUBA PARTS LIST	Series	Parts Group	Subclass Remark	Page
	VC008	VL		1/1
				Date
				2012/09/21

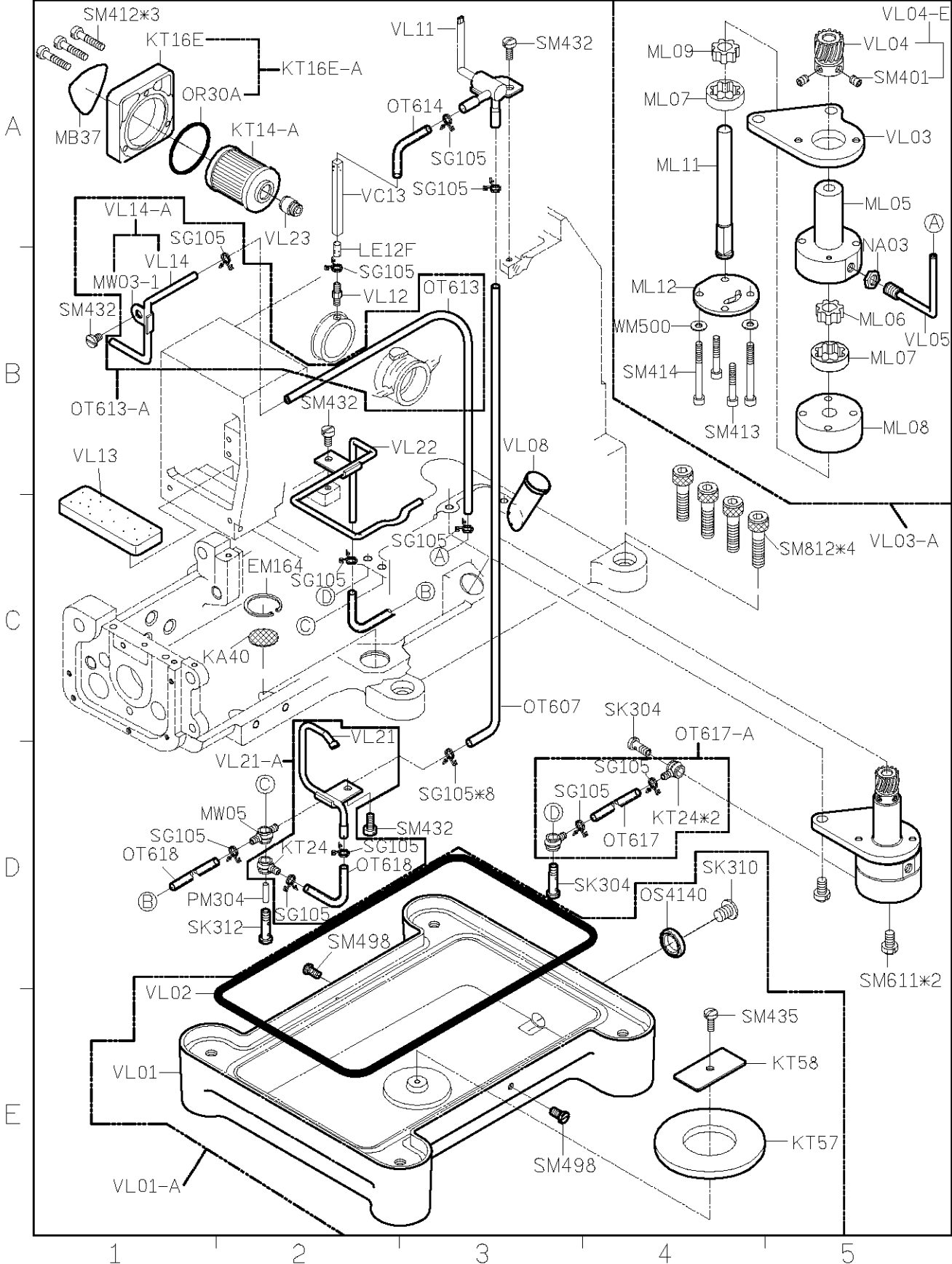

SIRUBA PARTS LIST	Series	Parts Group	Subclass / Remark	Page
	VC008	VN		1/3
				Date
				2014/03/13

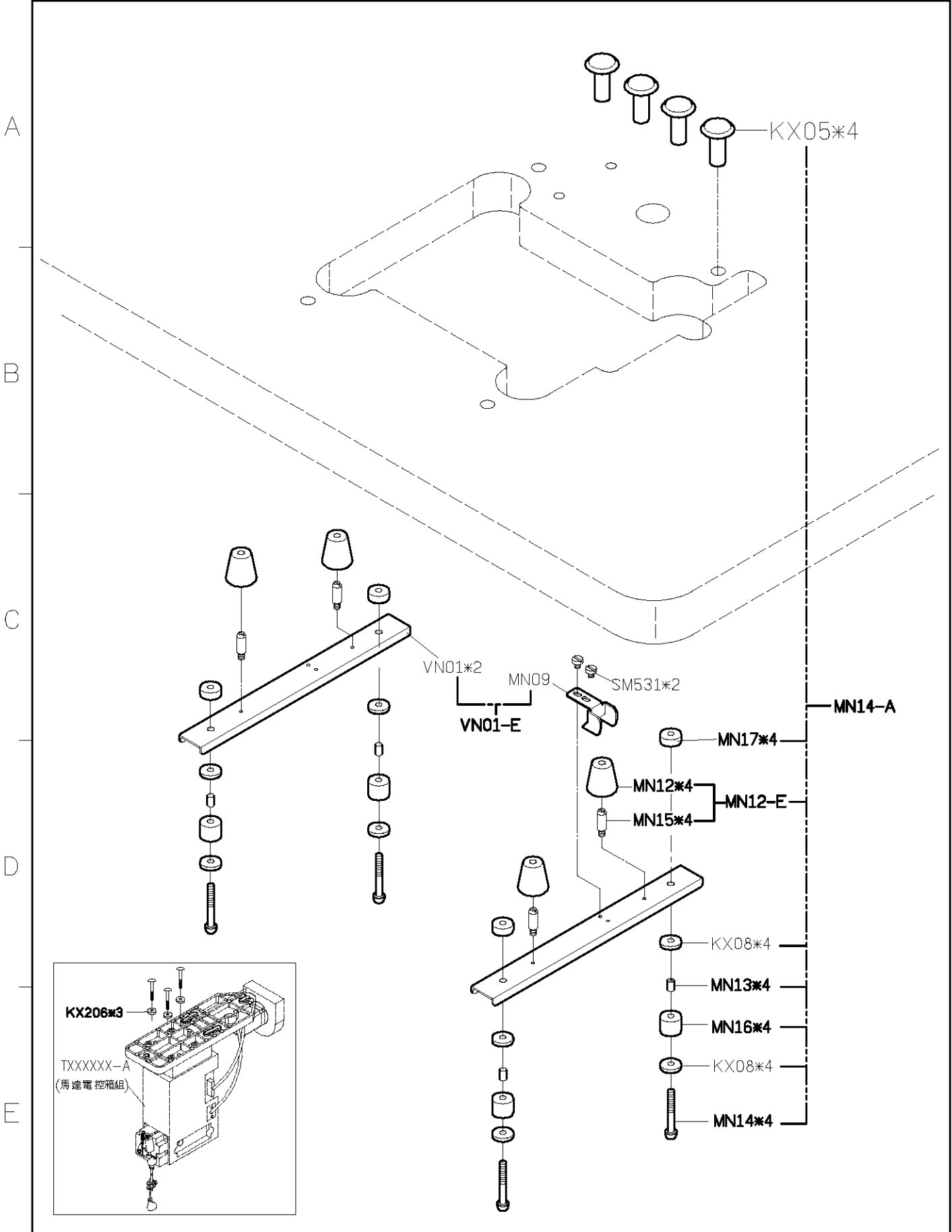

SIRUBA PARTS LIST	Series	Parts Group	Subclass / Remark	Page
	VC008	VN	Use for 上乘式桌板	2/3
				Date
				2014/03/19

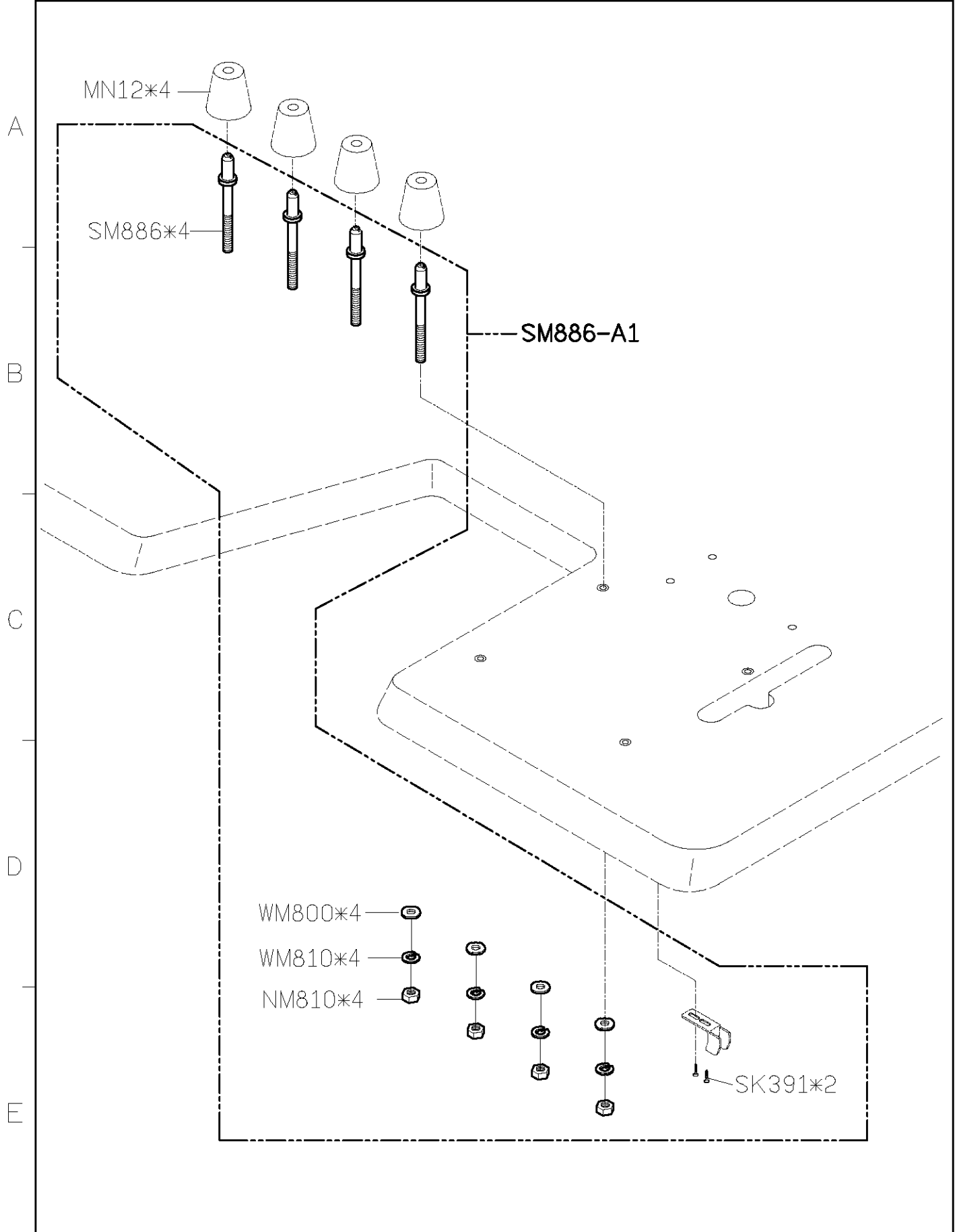

SIRUBA PARTS LIST	Series	Parts Group	Subclass / Remark	Page
	VC008	VN	Use for 全沉式桌板	3/3
				Date
				2014/03/13

A

B

C

D

E

1

2







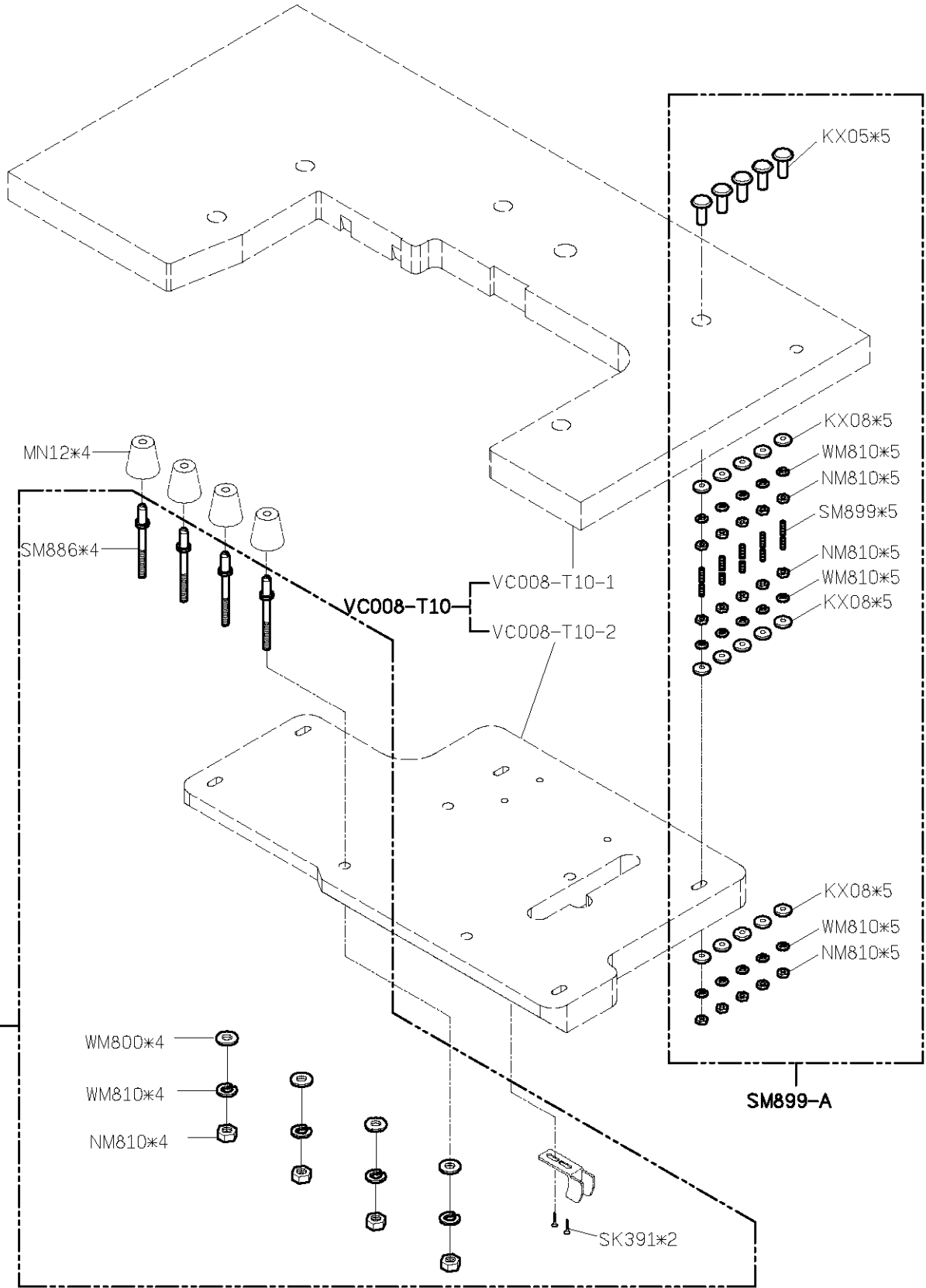



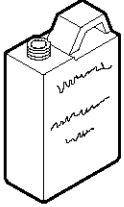





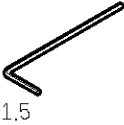

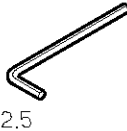
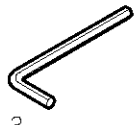
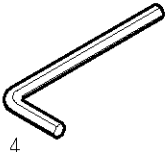
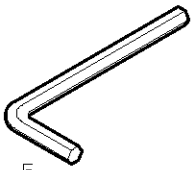
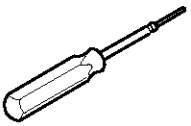
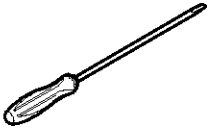
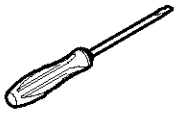
3

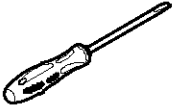
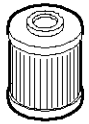
4

5

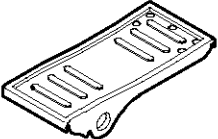

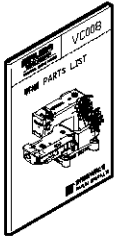
SIRUBA PARTS LIST	Series	Parts Group	Subclass / Remark	Page
	VC008	VY		1/2
				Date
				2012/09/23

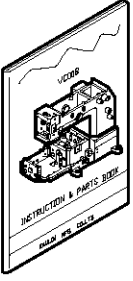
	MY01 防塵罩 	KY02F-A 油罐 	KY03 油壺 	KY04 漏斗 	KY07 開口扳手 	
A						
	KY08 開口扳手 	KY09 開口扳手 	MY09 六角扳手 	KY10 六角扳手 	MY10 六角扳手 	MY11 六角扳手 
B			1.5	2	2.5	3
	MY12 六角扳手 	KY11 六角扳手 	KY14 內六角螺絲起子 	KY16 一字起子 	KY17 一字起子 	
C						
	KY18 鑷子 	KY22 一字起子 (23針用) 	KT14-A 濾油器 	KY26F 工具袋 	KZ03 乾燥劑 	針*5 
D						
	KY20D-A 腳踏板 	KY21-1/MY21 鉤子/鍊條 	VY04 零件圖 	VY09 輔助件零件圖 	VY01/P 使用說明書 四針(十二針)車使用說明書 	
E						
	1	2	3	4	5	

SIRUBA PARTS LIST	Series	Parts Group	Subclass / Remark	Page
	VC008	VY		2/2
				Date
				2012/09/23

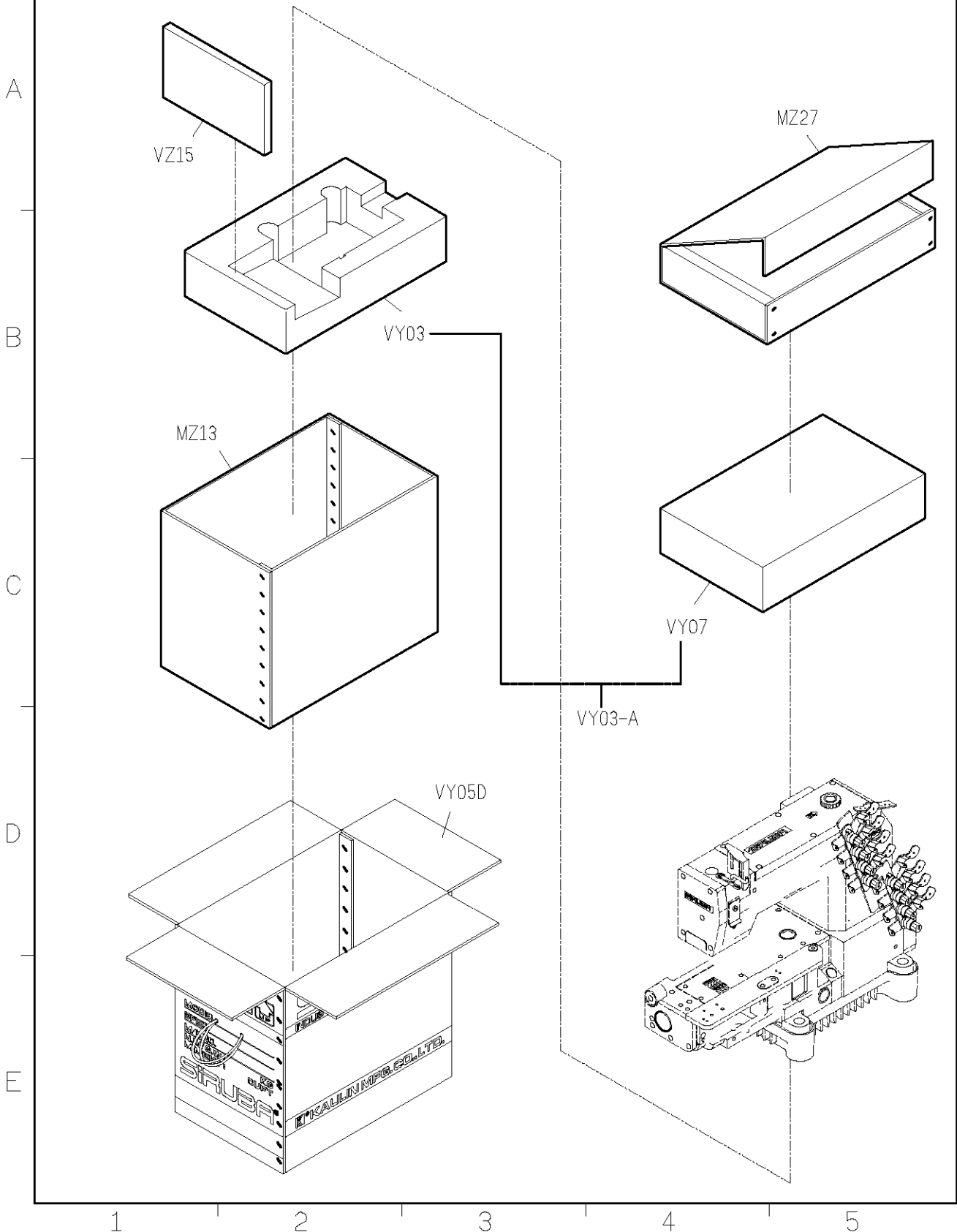

SIRUBA PARTS LIST	Series	Parts Group	Subclass / Remark	Page
	VC008	VZ		1/2
				Date
				2015/11/03

OPTION: VZ02-A
(4 NEEDLE USE)

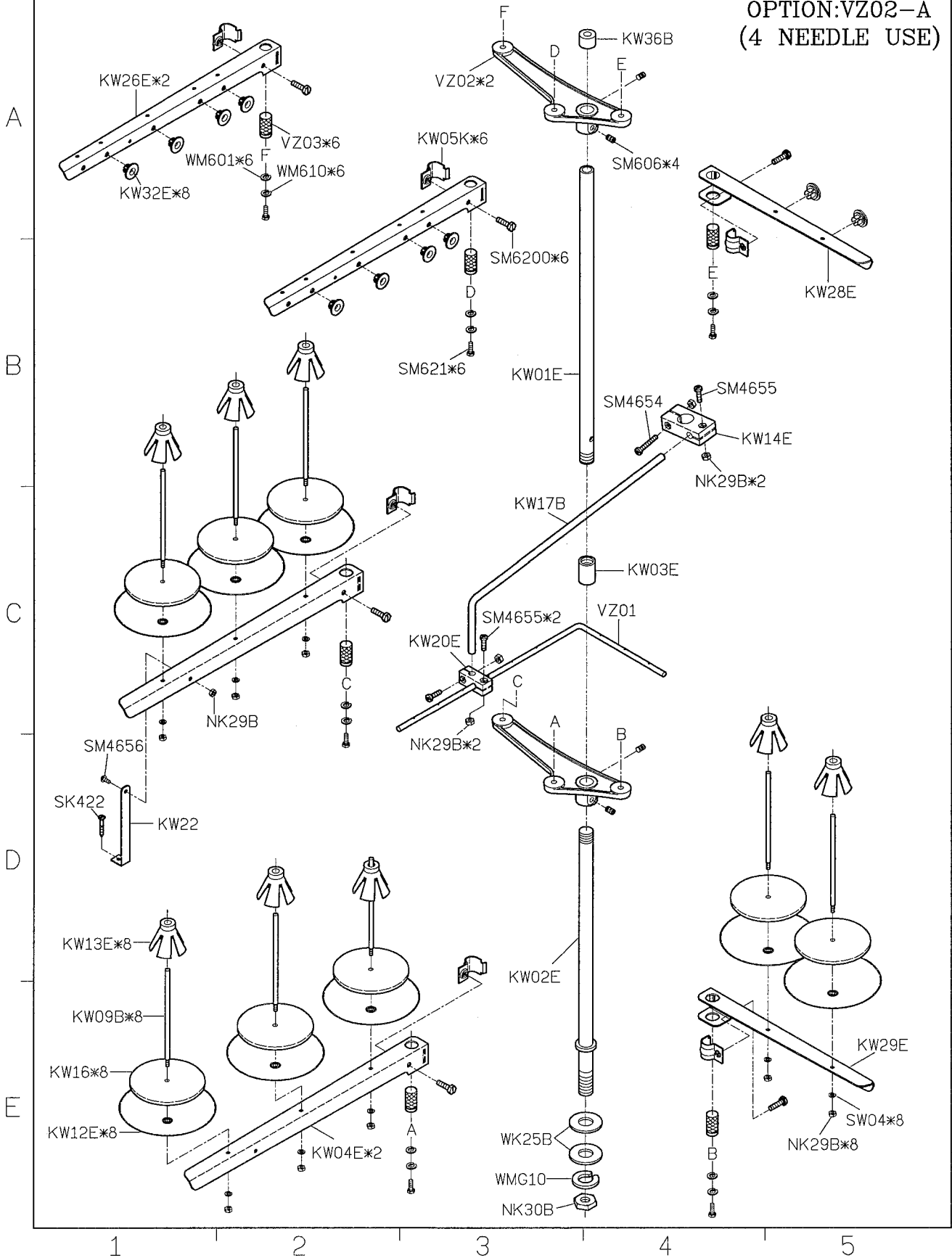

SIRUBA PARTS LIST	Series	Parts Group	Subclass / Remark	Page
	VC008	VZ		2/2
				Date
				2012/11/15

**OPTION:VZ09-A
(FOR 6~12 NEEDLE USE)**

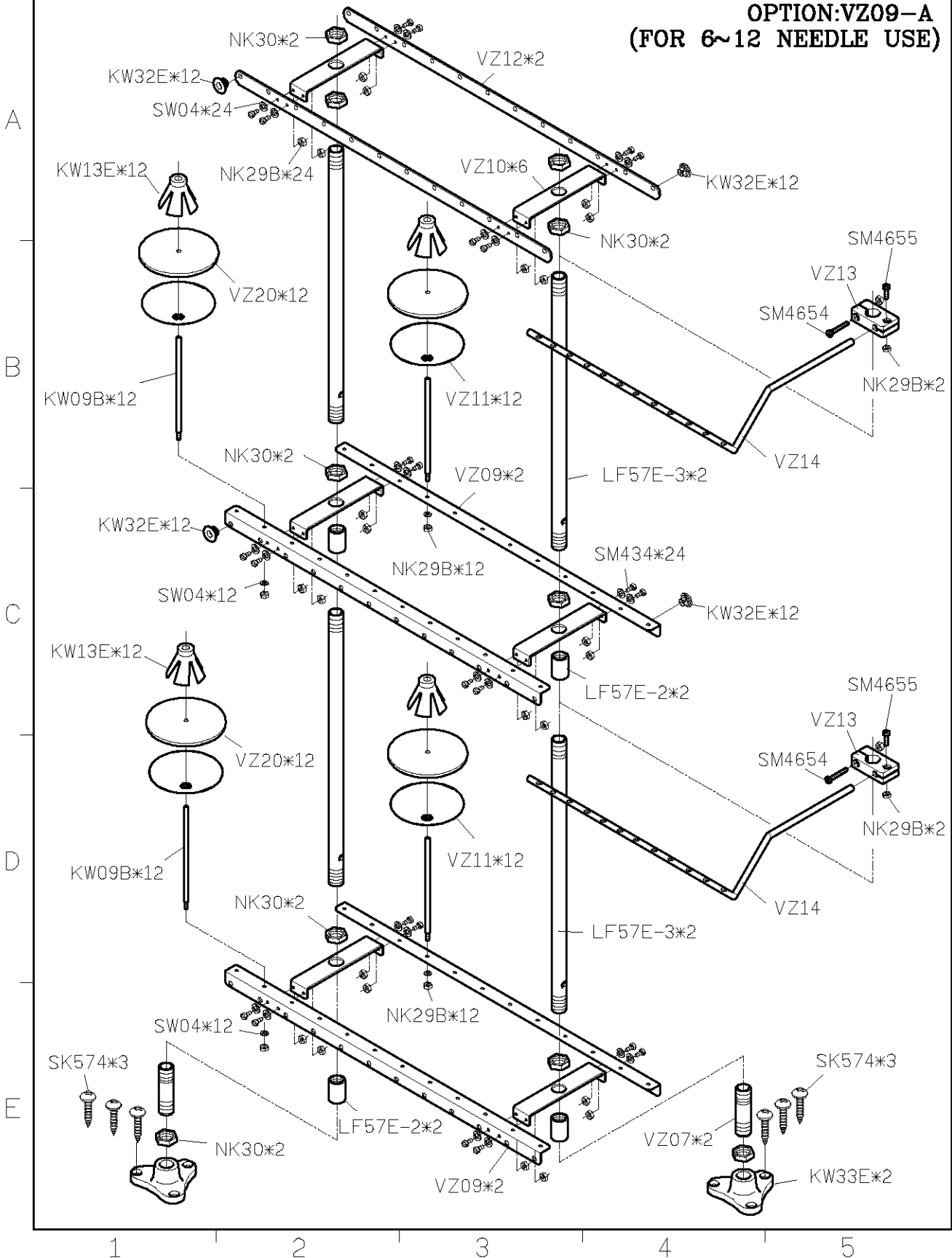

SIRUBA TABLE CUT - OUT	Series	Item Code	Subclass Remark	Mounting
	VC008	VC008-T1	For VC008-04 VC008-04P/VCE VC008-04P/VJT VC008-04P/VSF	Semi-submerged
				Date
				2012/11/08

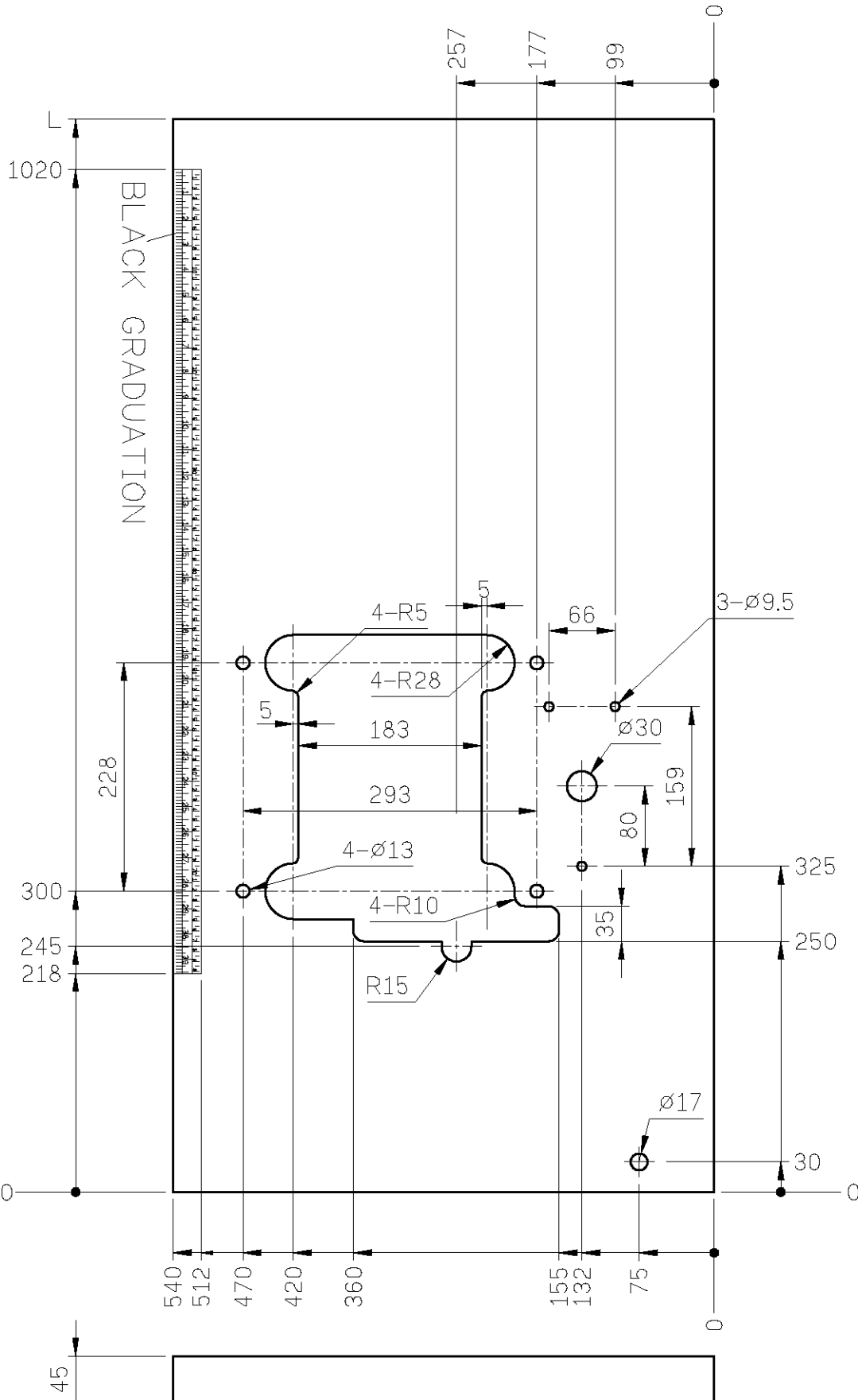

單位 / UNIT : mm
 所有尺寸公差 / TOLERANCE : ±2
 長度 (L) : 1070 / 重量 (W) : 11.6kg ±5%
 長度 (L) : 1200 / 重量 (W) : 12.6kg ±5%

SIRUBA TABLE CUT - OUT	Series	Item Code	Subclass Remark	Mounting
	VC008	VC008-T2	For VC008-04 VC008-04P/VCE VC008-04P/VJT VC008-04P/VSF	Non-submerged
				Date
				2012/11/08

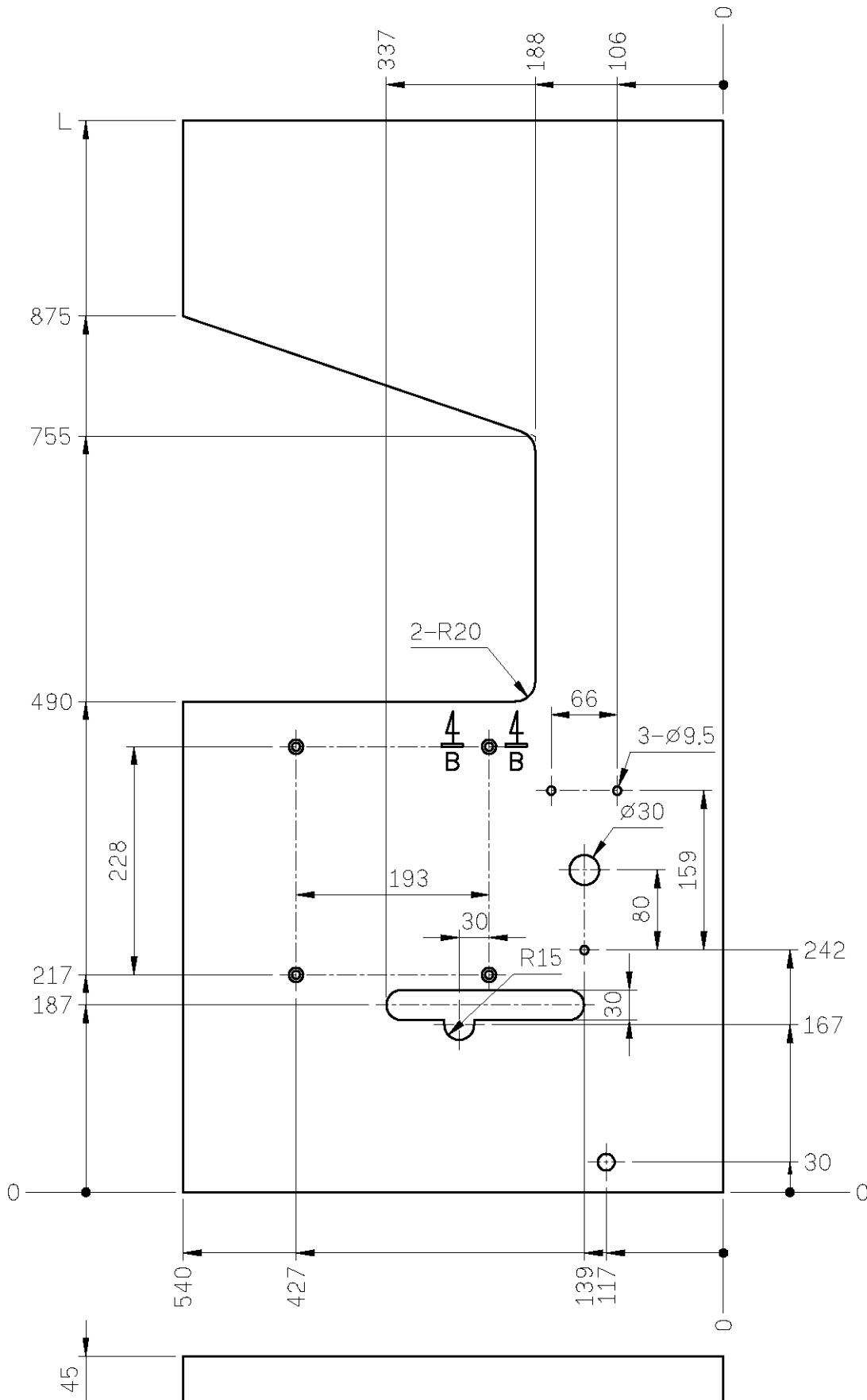

單位 / UNIT : mm
 所有尺寸公差 / TOLERANCE : ±2
 長度 (L) : 1070 / 重量 (W) : 11.4kg ±5%
 長度 (L) : 1200 / 重量 (W) : 12.4kg ±5%

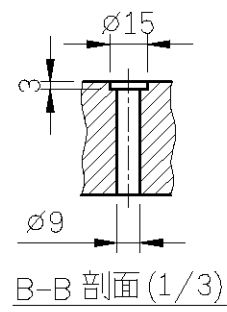

SIRUBA TABLE CUT - OUT	Series	Item Code	Subclass Remark	Mounting
	VC008	VC008-T3	For VC008-12、VC008-13 VC008-06/VPL VC008-12/VPQ VC008-12/VPT VC008-12/VUT	Semi-submerged
				Date
				2012/11/08

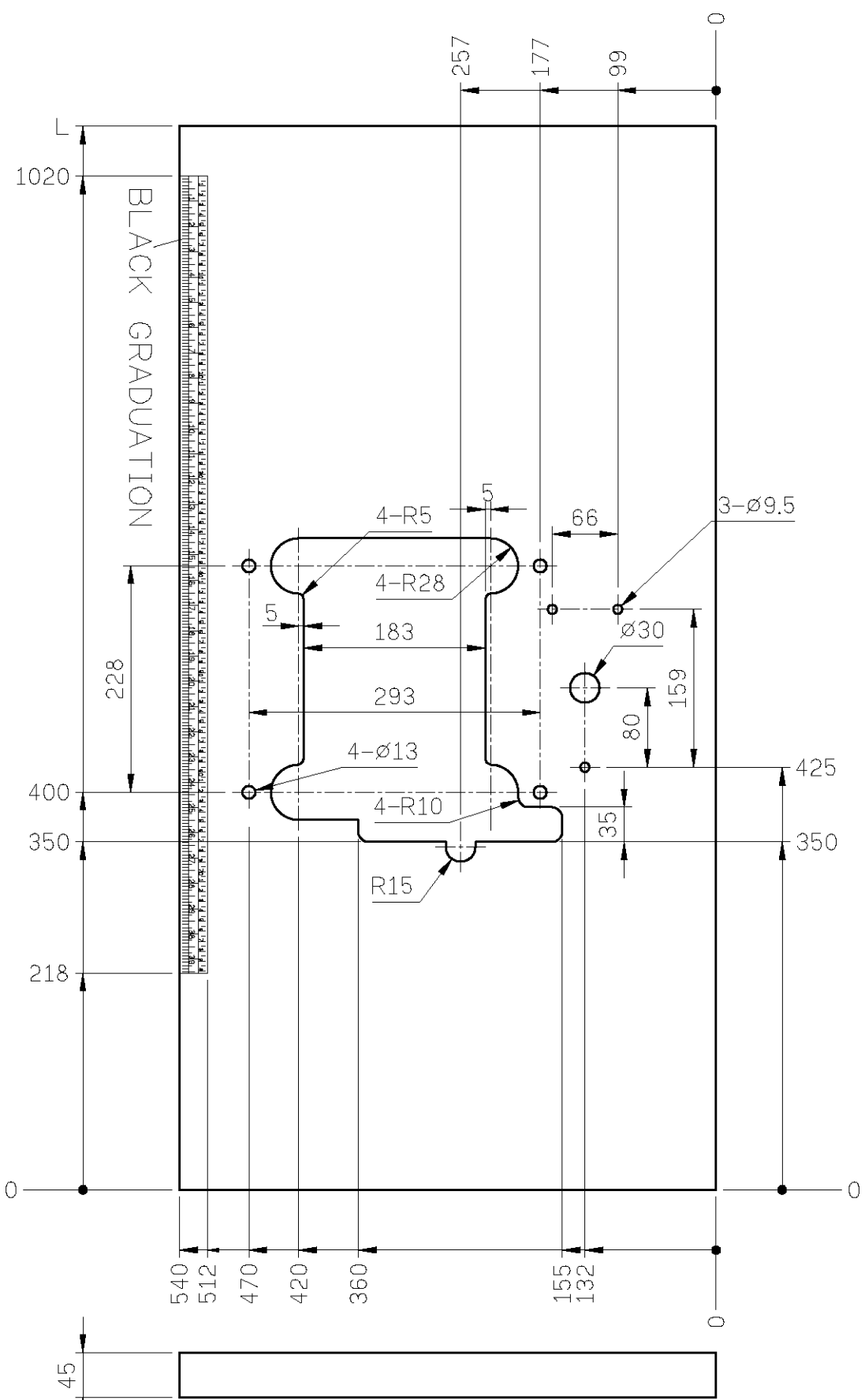

單位 / UNIT : mm
 所有尺寸公差 / TOLERANCE : ±2
 長度 (L) : 1070 / 重量 (W) : 11.6kg ±5%
 長度 (L) : 1200 / 重量 (W) : 12.6kg ±5%

SIRUBA TABLE CUT - OUT	Series	Item Code	Subclass Remark	Mounting
	VC008	VC008-T4	For VC008-12、VC008-13 VC008-06/VPL VC008-12/VPQ VC008-12/VPT VC008-12/VUT	Non-submerged
				Date
				2012/11/08

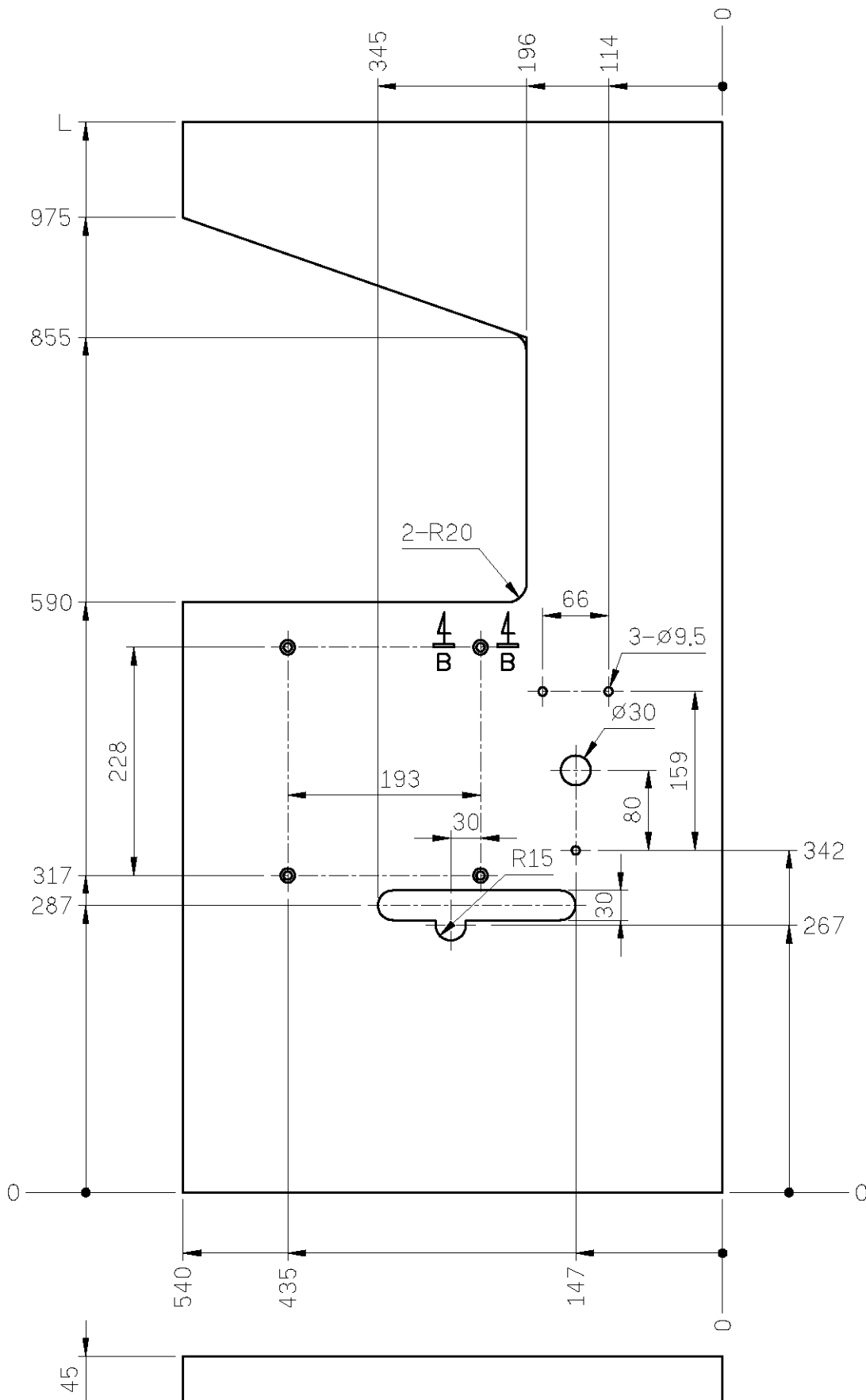

單位 / UNIT : mm
 所有尺寸公差 / TOLERANCE : ±2
 長度 (L) : 1070 / 重量 (W) : 11.4kg ±5%
 長度 (L) : 1200 / 重量 (W) : 12.4kg ±5%

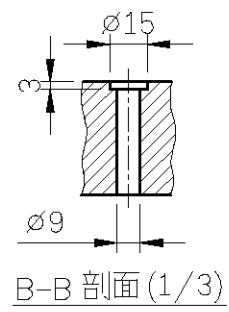

SIRUBA TABLE CUT - OUT	Series	Item Code	Subclass Remark	Mounting
	VC008	VC008-T5	For VC008-04/VWL VC008-04/VWLB VC008-04/VWLC	Semi-submerged
				Date
				2012/11/08

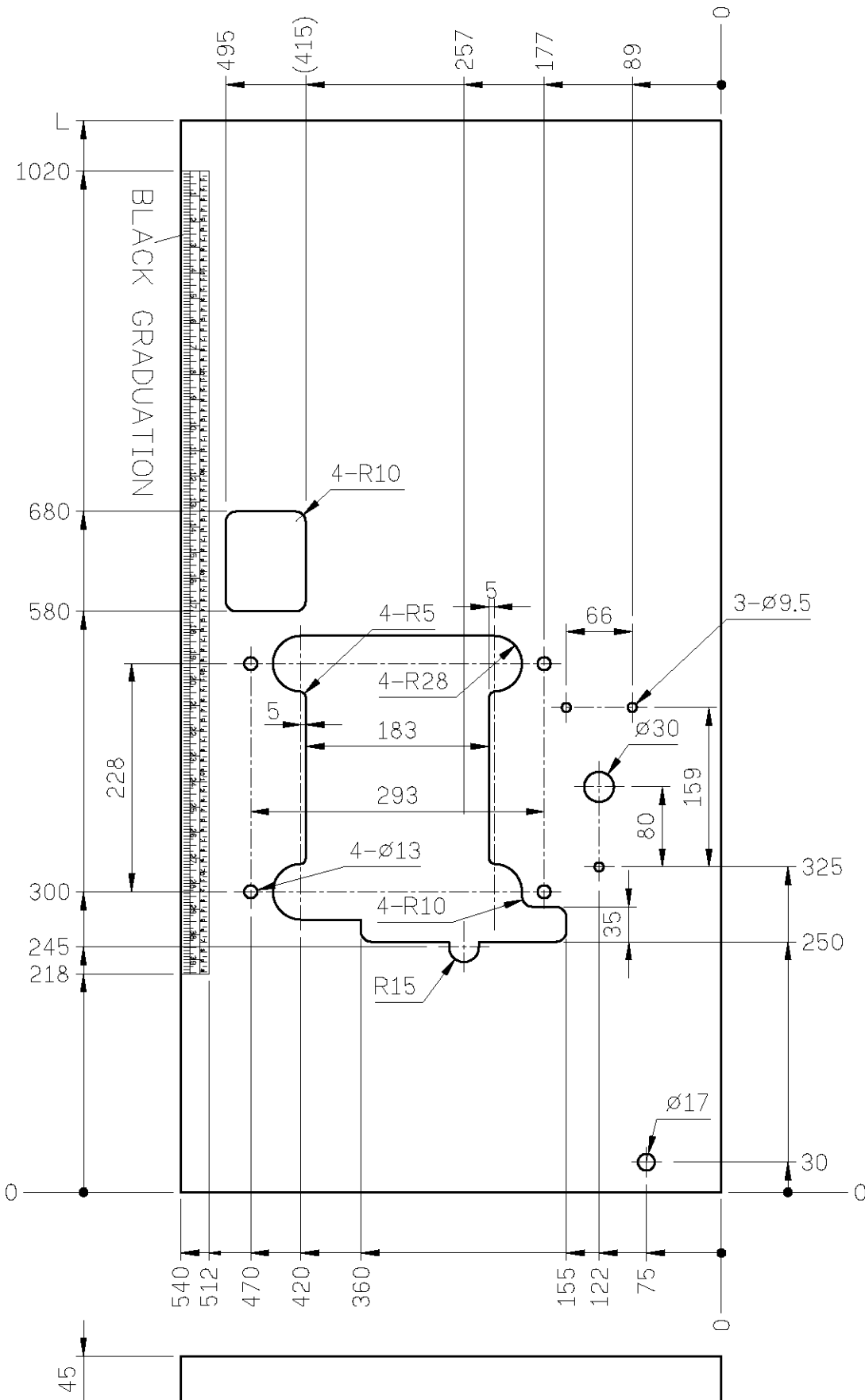

單位 / UNIT : mm
 所有尺寸公差 / TOLERANCE : ± 2
 長度 (L) : 1070 / 重量 (W) : 11.5kg $\pm 5\%$
 長度 (L) : 1200 / 重量 (W) : 12.5kg $\pm 5\%$

SIRUBA TABLE CUT - OUT	Series	Item Code	Subclass Remark	Mounting
	VC008	VC008-T6	For VC008-12/VPQK VC008-12/VWL VC008-12/VSSM	Semi-submerged
				Date
				2015/12/16

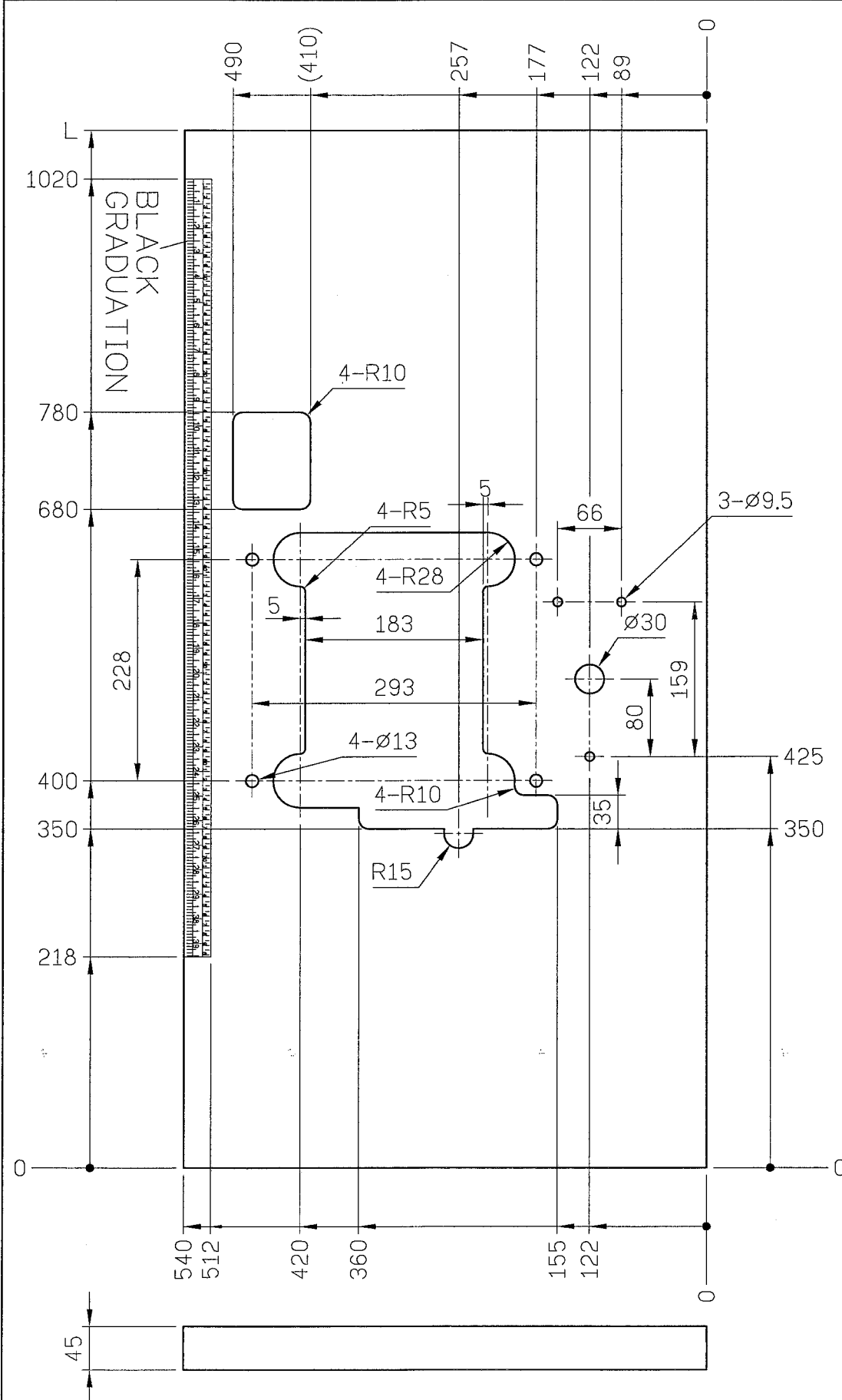

單位/UNIT:mm
所有尺寸公差/TOLERANCE:±2
長度(L):1070/重量(W):11.5kg±5%
長度(L):1200/重量(W):12.5kg±5%

SIRUBA TABLE CUT - OUT	Series	Item Code	Subclass Remark	Mounting
	VC008	VC008-T7	For VC008-02/VMR	Semi-submerged
				Date
				2012/11/08

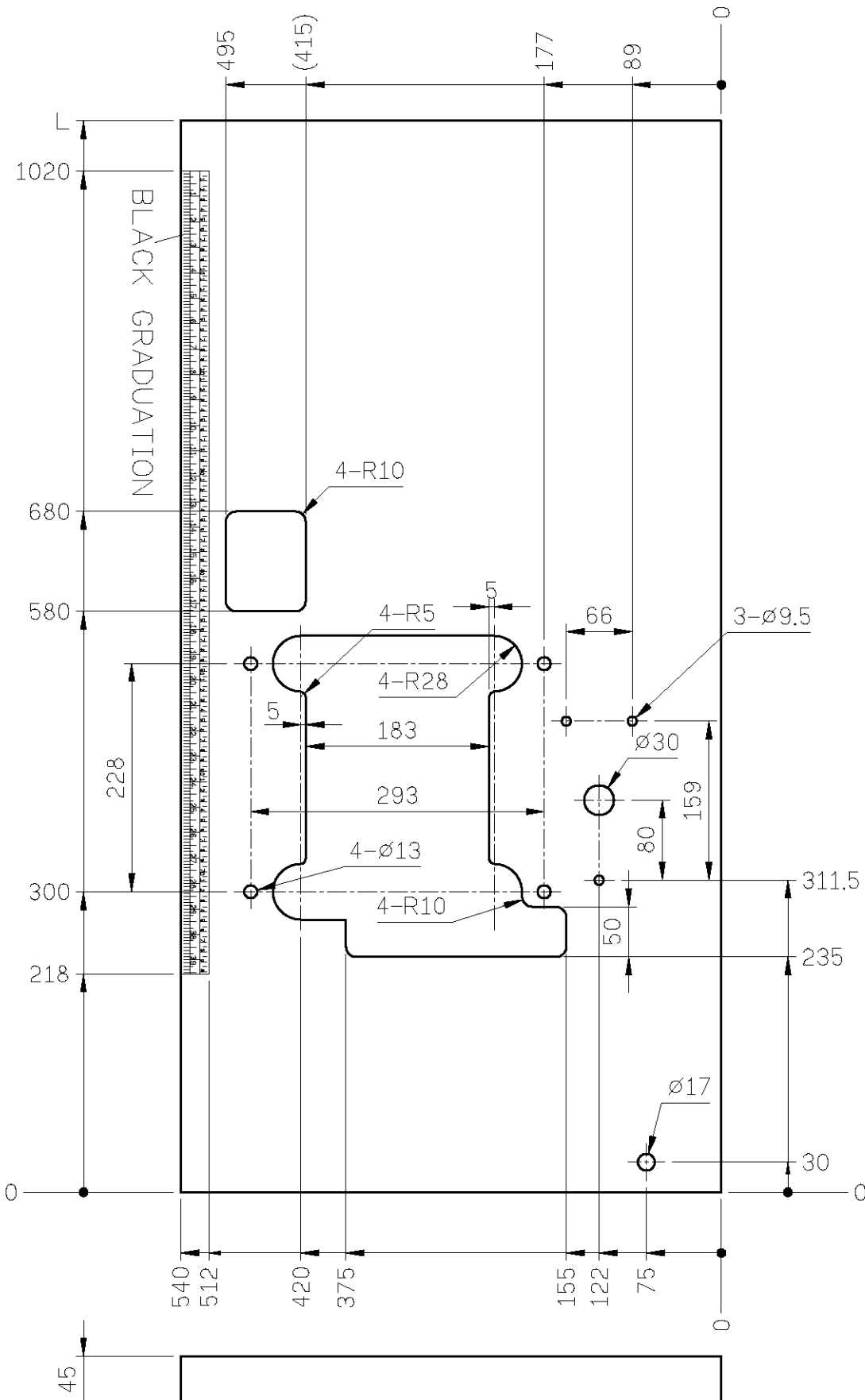

單位 / UNIT : mm
 所有尺寸公差 / TOLERANCE : ±2
 長度 (L) : 1070 / 重量 (W) : 11.6kg ±5%
 長度 (L) : 1200 / 重量 (W) : 12.6kg ±5%

SIRUBA TABLE CUT - OUT	Series	Item Code	Subclass Remark	Mounting
	VC008	VC008-T8	For VC008-12/VSM VC008-12/VSQ	Semi-submerged
				Date
				2012/11/08

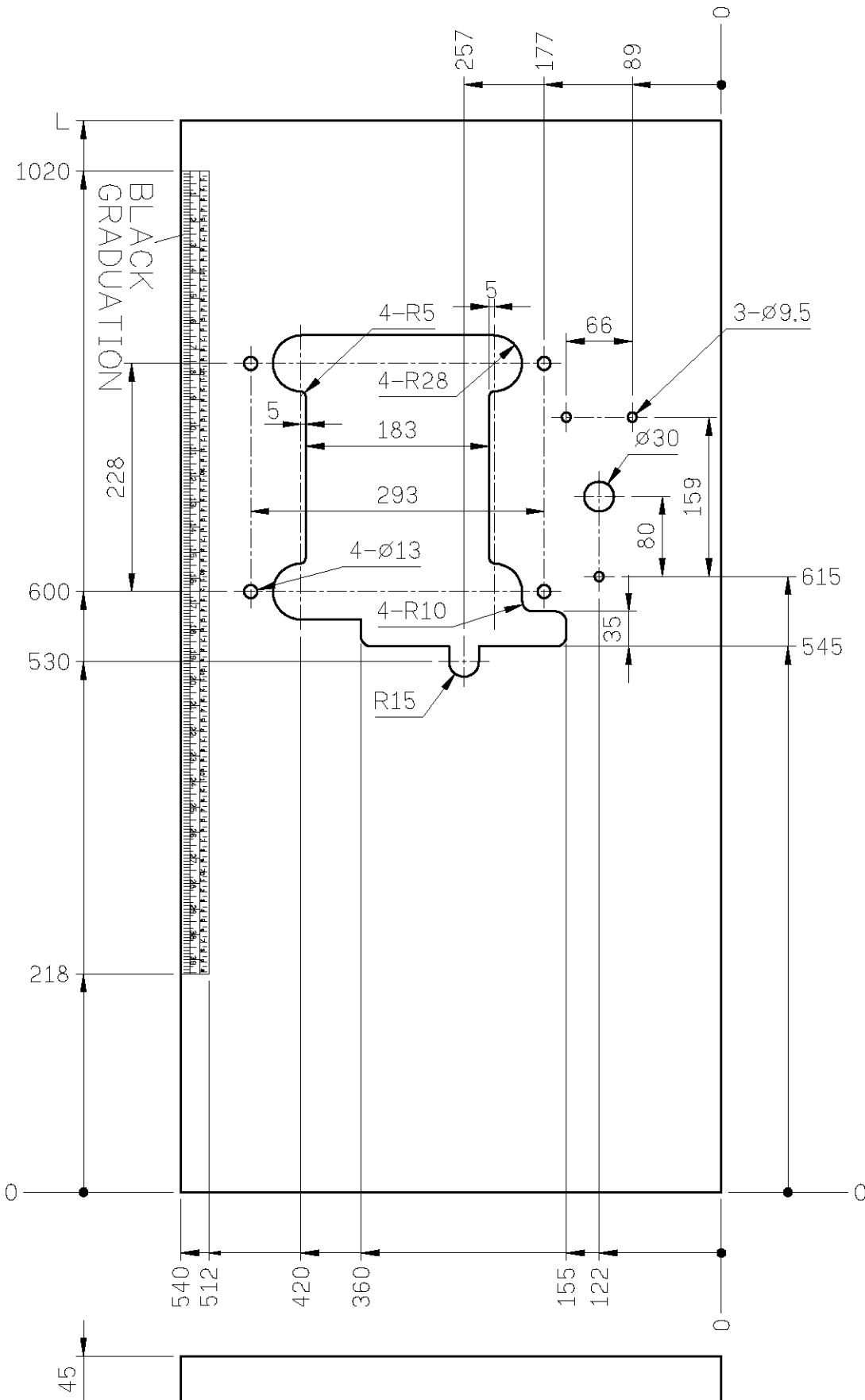

單位 / UNIT : mm
 所有尺寸公差 / TOLERANCE : ±2
 長度 (L) : 1070 / 重量 (W) : 11.6kg ±5%
 長度 (L) : 1200 / 重量 (W) : 12.6kg ±5%

SIRUBA TABLE CUT - OUT	Series	Item Code	Subclass Remark	Mounting
	VC008	VC008-T9	For VC008-12/VSC	Semi-submerged
				Date
				2015/12/16

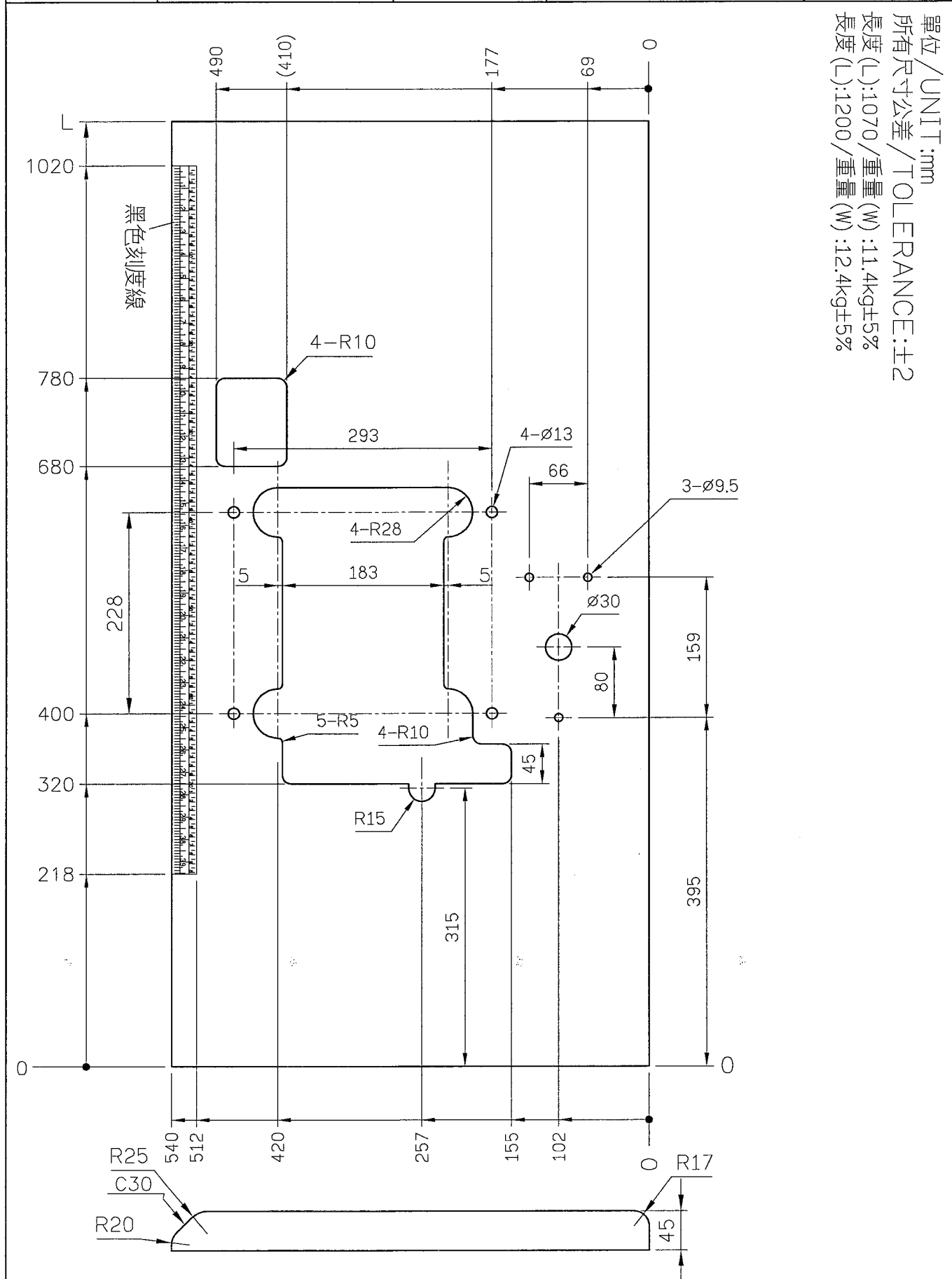

SIRUBA TABLE CUT - OUT	Series	Item Code	Subclass Remark	Mounting
	VC008	VC008-T10-1	For VC008-04、VC008-12	Fully-submerged
				Date
				2015/11/19

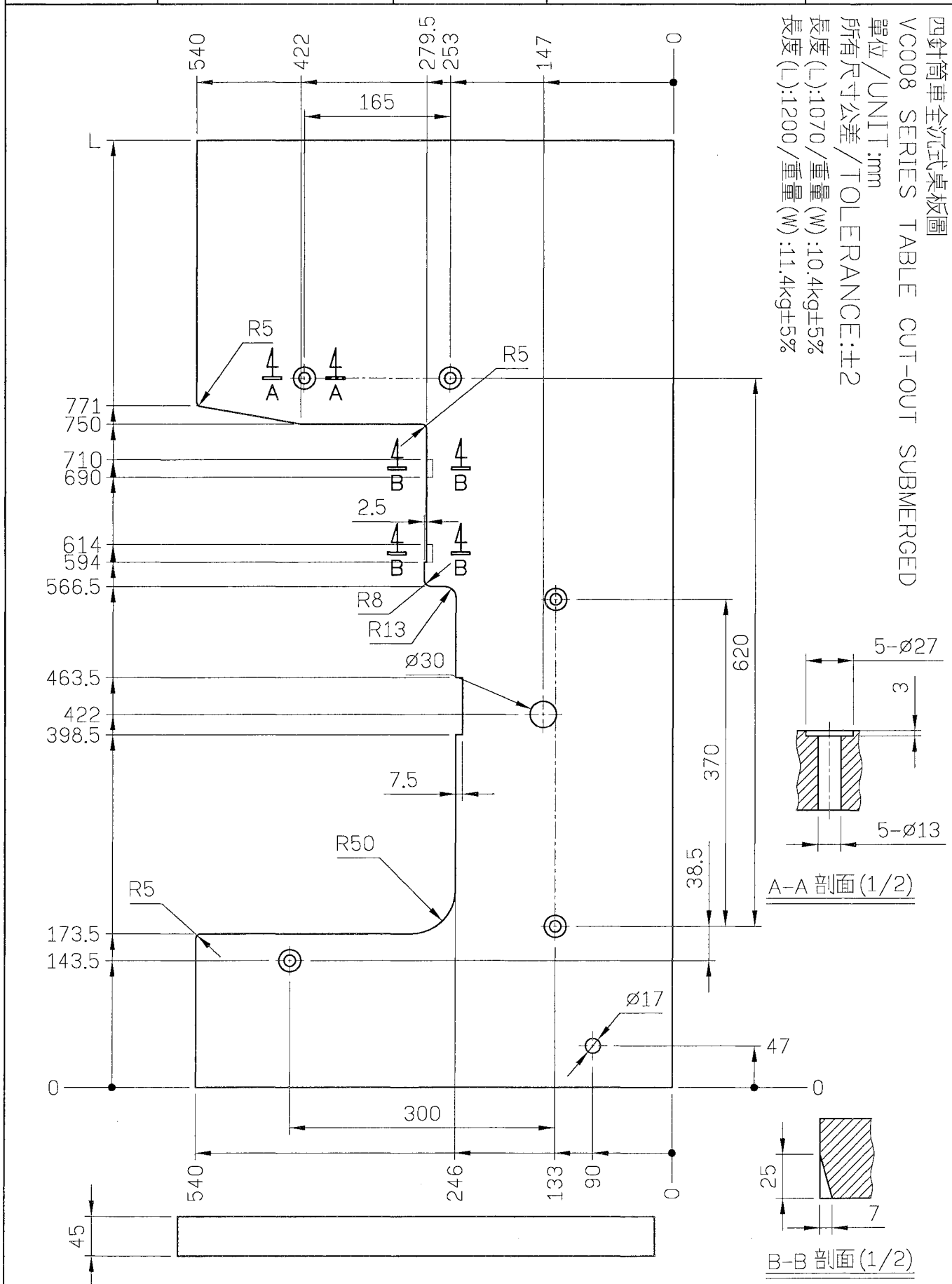

SIRUBA TABLE CUT - OUT	Series	Item Code	Subclass Remark	Mounting
	VC008	VC008-T10-2	For VC008-04、VC008-12	Fully-submerged
				Date
				2015/11/19

四針筒車全沉式桌板圖
 VC008 SERIES TABLE CUT-OUT SUBMERGED
 單位/UNIT:mm
 所有尺寸公差/TOLERANCE:±2
 重量(W):6.1kg±5%

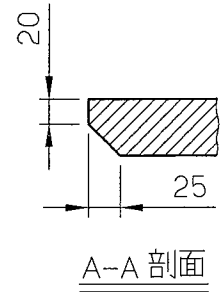
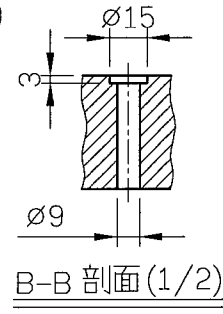
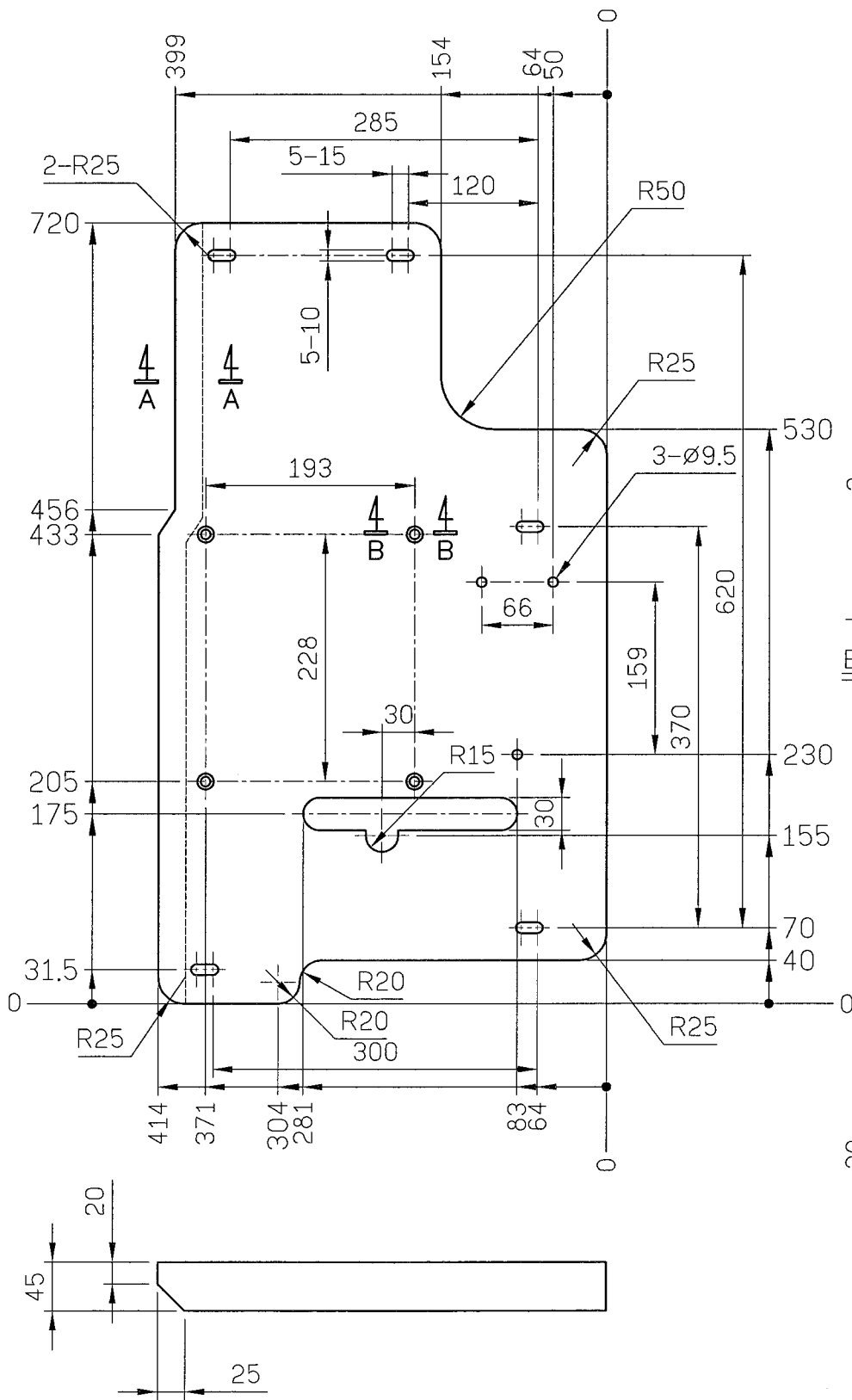

SIRUBA TABLE CUT - OUT	Series	Item Code	Subclass Remark	Mounting
	VC008	VC008-T21	For VC008:P/PQS/PTV	Semi-submerged
				Date
				2012/12/08

三十五針(以上)簡單—ODM桌板圖
單位/UNIT:mm
所有尺寸公差/DIFFERENCE:±2
VC008-T21長度(L):1200/重量:22.5kg±5% 板厚:45mm
全封邊灰格紋光塑面台板

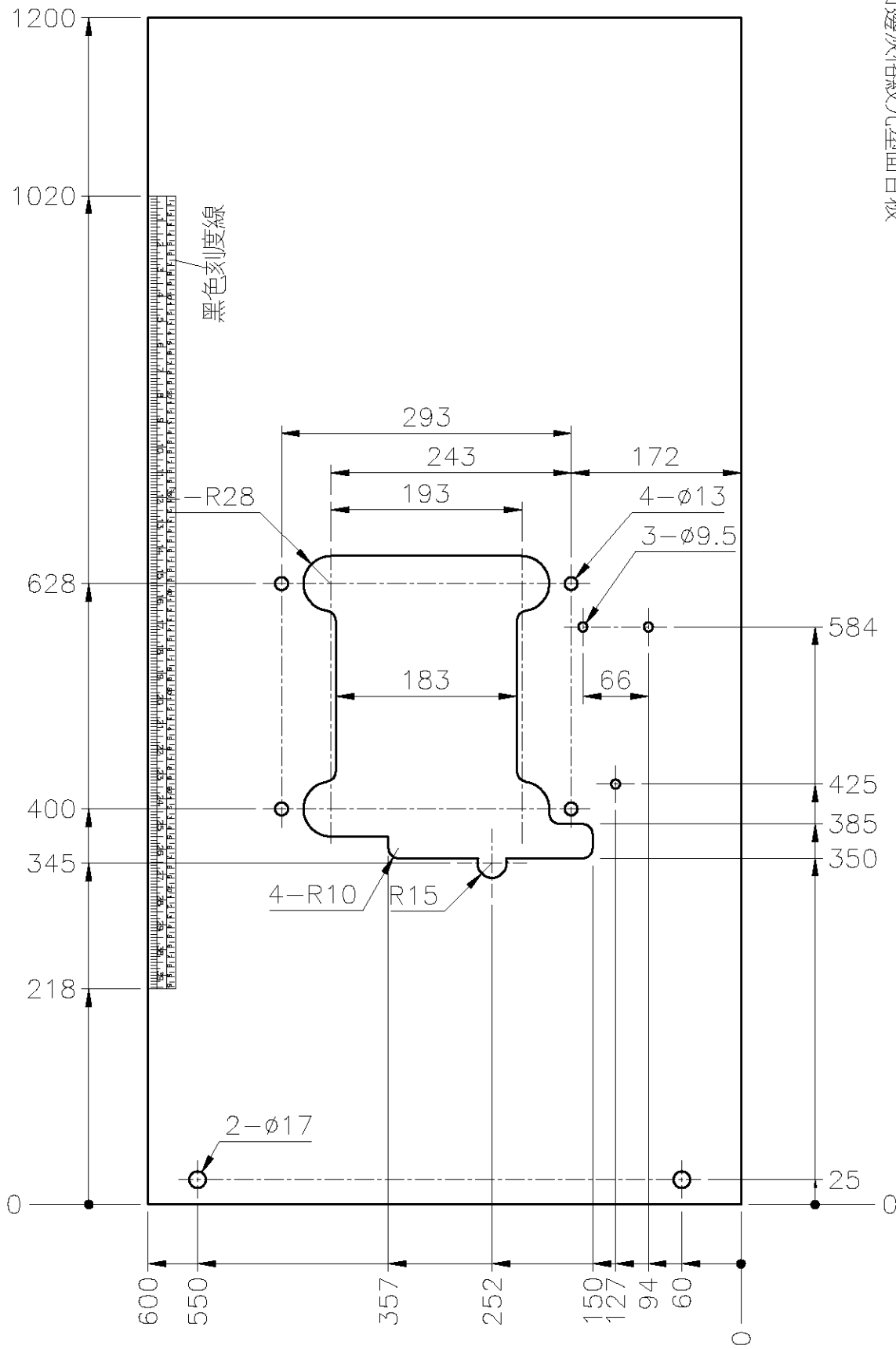

SIRUBA TABLE CUT - OUT	Series	Item Code	Subclass Remark	Mounting
	VC008	VC008-T22	For VC008/PQ2/PQ3/PQV	Semi-submerged
				Date
				2012/12/08

三十五針(以上)簡單—ODM桌板圖
單位/UNIT:mm
所有尺寸公差/DIFFERENCE:±2
VC008-T22長度(L):1200/重量:22.5kg±5% 板厚:45mm
全封邊灰格紋光塑面台板

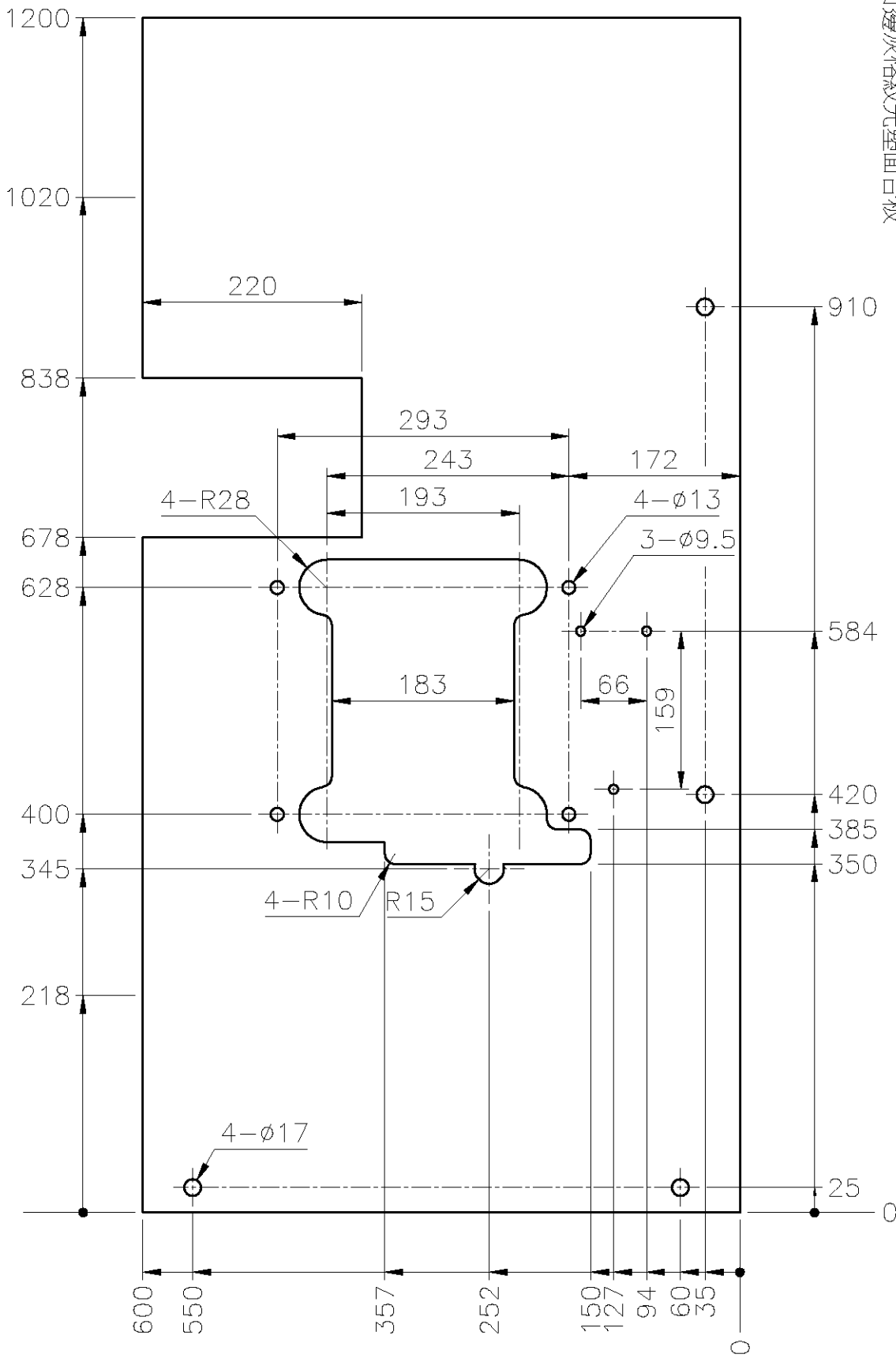

SIRUBA TABLE CUT - OUT	Series	Item Code	Subclass Remark	Mounting
	VC008	VC008-T23	For VC008/PSM/PQSM/PQ2R	Semi-submerged
				Date
				2012/12/08

三十五針(以上)簡單一ODM桌板圖
單位/UNIT:mm
所有尺寸公差/DIFFERENCE:±2
VC008-T23長度(L):1200/重量:22.5kg±5% 板厚:45mm
全封邊灰格紋光塑面台板

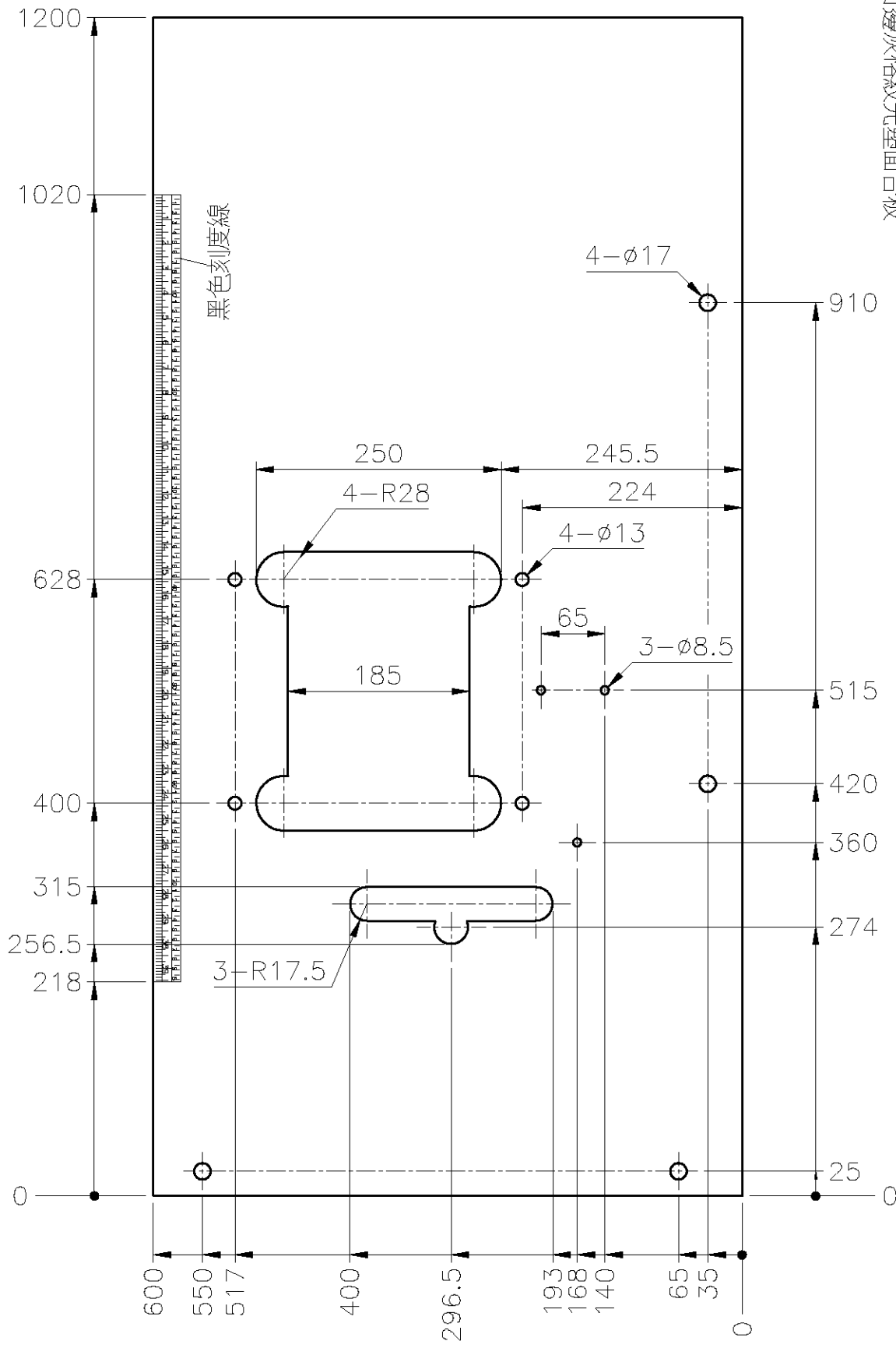

SIRUBA TABLE CUT - OUT	Series	Item Code	Subclass Remark	Mounting
	VC008	VC008-T24	For VC008/PSSM/PQ3M/PQTM	Semi-submerged
				Date
				2012/12/08

三十五針(以上)簡單—ODM桌板圖
單位/UNIT:mm
所有尺寸公差/DIFFERENCE:±2
VC008-T24長度(L):1200/重量:22.5kg±5% 板厚:45mm
全封邊加格紋光塑面台板

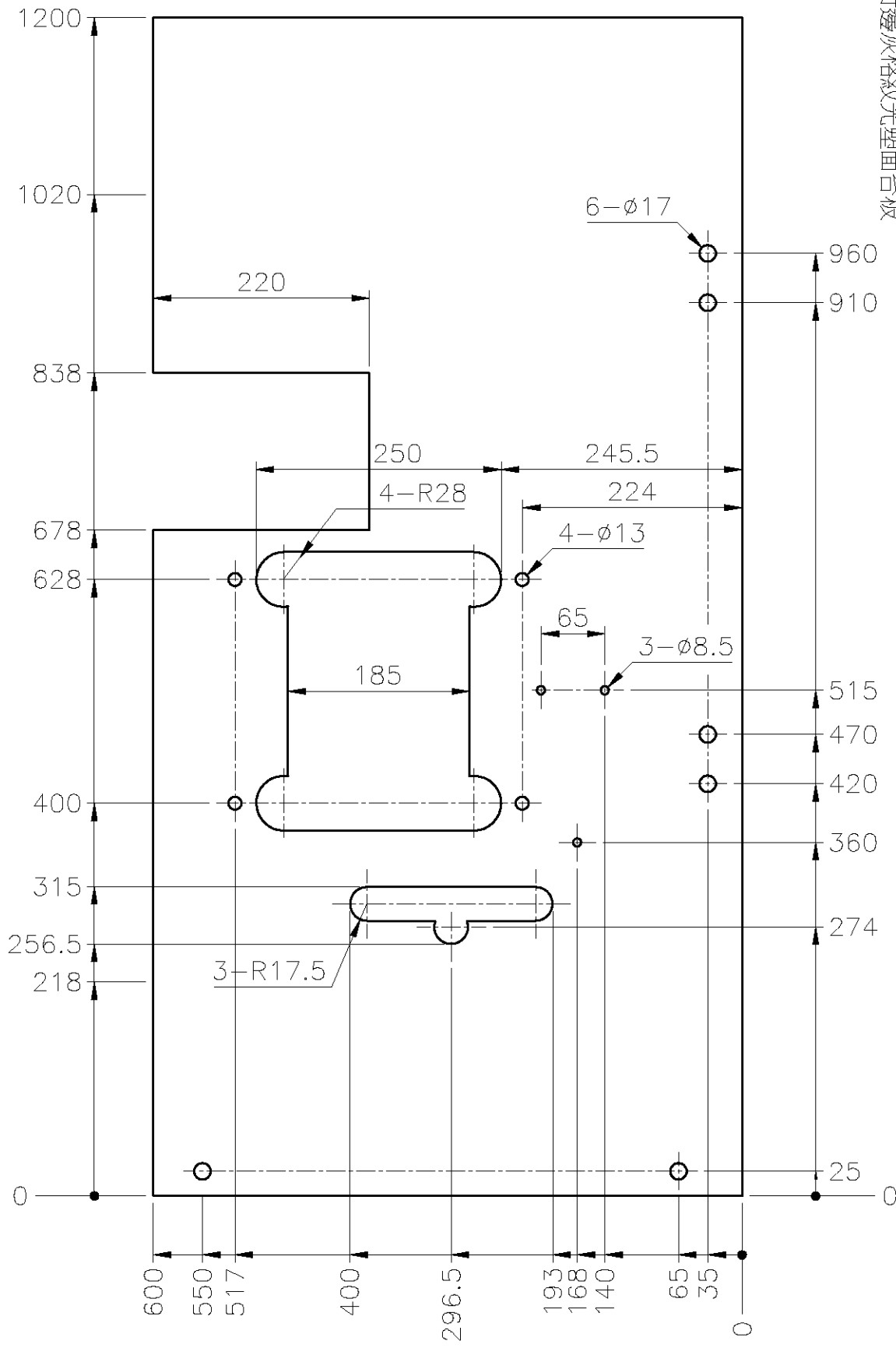

SIRUBA TABLE CUT - OUT	Series	Item Code	Subclass Remark	Mounting
	VC008	VC008-T25	For SLA特規要求	Non-submerged
				Date
				2014/08/21

