

# SIRUBA®

銀箭牌工業用縫紉機  
INDUSTRIAL SEWING MACHINE

## R718 WITH TRIMMER

## R728 WITH TRIMMER









### 零件圖 PARTS LIST

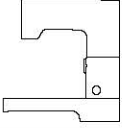

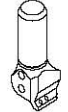
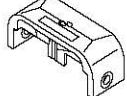
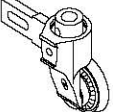

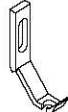



CE



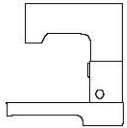

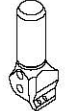
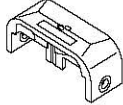
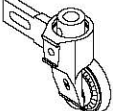
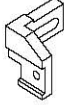
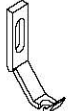

高林股份有限公司  
KAULIN MFG. CO., LTD.

From the library of: Superior Sewing Machine & Supply LLC

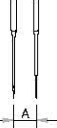

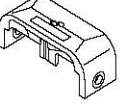
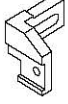
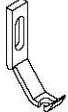

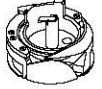
													
MODEL	NEEDLE GAUGE SIZE	OPERATING PANEL	NEEDLE CLAMP	NEEDLE PLATE	PRESSER FOOT ASM		ROLLER HOLDER BRACKET	NEEDLE GUARD	NEEDLE	HOOK ASM	BOBBIN CAP	BOBBIN	
機 型	針 幅	操作盒	針 座	針 板	輪錢組		滾輪支座	頂針片	針 號	梭 頭	梭 帽	梭 子	
R718-01-00	—	—	—	E700Q	中	RE23P-A	中	RE36					
R718-01-02													
R718-01-04													
R718-01-05													
R718-01-10		C300M-A1											
R718-01-12													
R718-01A-00	—	—	—	E700Q	小	RE23-A	小	RE27	—	DP*5#16	G155	G403	G305
R718-01A-02													
R718-01A-04													
R718-01A-05													
R718-01A-10		C300M-A1											
R718-01A-12													
R718-01B-00	—	—	—	E700Q	大	RE23Q-A	大	RE29					
R718-01B-02													
R718-01B-04													
R718-01B-05													
R718-01B-10		C300M-A1											
R718-01B-12													



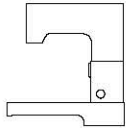
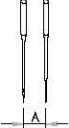
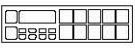
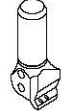
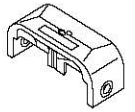
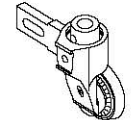
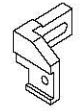
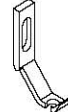

# 規格件表 CONVERSION CHART-2

													
MODEL	NEEDLE GAUGE SIZE	OPERATING PANEL	NEEDLE CLAMP	NEEDLE PLATE	PRESSER FOOT ASM	ROLLER HOLDER BRACKET	NEEDLE GUARD	NEEDLE	HOOK ASM	BOBBIN CAP	BOBBIN		
機 型	針 幅	操作盒	針 座	針 板	輪錢組	滾輪支座	頂針片	針 號	梭 頭	梭 帽	梭 子		
R718-02-00	—	—	—	E710Q	中	RE23P-A	—	—	—	—	—		
R718-02-02													
R718-02-02E													
R718-02-04													
R718-02-05													
R718-02-05E													
R718-02-10													
R718-02-12	C300M-A1	—	—	E710Q	小	RE23-A	小	RE27	—	DP*5#16	G155	G403	G305
R718-02-12E													
R718-02A-00	—	—	—	E710Q	大	RE23Q-A	—	—	—	—	—		
R718-02A-02													
R718-02A-02E													
R718-02A-04													
R718-02A-05													
R718-02A-05E													
R718-02A-10												C300M-A1	—
R718-02A-12													
R718-02A-12E													
R718-02B-00	—	—	—	E710Q	大	RE23Q-A	—	—	—	—	—		
R718-02B-02													
R718-02B-02E													
R718-02B-04													
R718-02B-05													
R718-02B-05E													
R718-02B-10												C300M-A1	—
R718-02B-12													
R718-02B-12E													



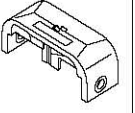



													
MODEL	NEEDLE GAUGE SIZE	OPERATING PANEL	NEEDLE CLAMP	NEEDLE PLATE	PRESSER FOOT ASM	ROLLER HOLDER BRACKET	NEEDLE GUARD	NEEDLE	HOOK ASM	BOBBIN CAP	BOBBIN		
機 型	針 幅	操作盒	針 座	針 板	輪錢組	滾輪支座	頂針片	針 號	梭 頭	梭 帽	梭 子		
R728-16-00 R728-16-02 R728-16-02E R728-16-04 R728-16-05 R728-16-05E	1.6	—	M728	E716Q	中	RE23P-A	中	RE36					
R728-16-10 R728-16-12 R728-16-12E		C300M-A1											
R728-16A-00 R728-16A-02 R728-16A-02E R728-16A-04 R728-16A-05 R728-16A-05E	1.6	—	M728	E716Q	小	RE23-A	小	RE27	RF31S	DP*5#16	G155	G403	G305
R728-16A-10 R728-16A-12 R728-16A-12E		C300M-A1											
R728-16B-00 R728-16B-02 R728-16B-02E R728-16B-04 R728-16B-05 R728-16B-05E	1.6	—	M728	E716Q	大	RE23Q-A	大	RE29					
R728-16B-10 R728-16B-12 R728-16B-12E		C300M-A1											

# 規格件表 CONVERSION CHART-4

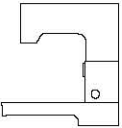
													
MODEL	NEEDLE GAUGE SIZE	OPERATING PANEL	NEEDLE CLAMP	NEEDLE PLATE	PRESSER FOOT ASM	ROLLER HOLDER BRACKET	NEEDLE GUARD	NEEDLE	HOOK ASM	BOBBIN CAP	BOBBIN		
機 型	針 幅	操作盒	針 座	針 板	輪錢組	滾輪支座	頂針片	針 號	梭 頭	梭 帽	梭 子		
R728-20-00 R728-20-02 R728-20-02E R728-20-04 R728-20-05 R728-20-05E	2.0	—	M728	E720Q	中	RE23P-A	中	RE36					
R728-20-10 R728-20-12 R728-20-12E		C300M-A1											
R728-20A-00 R728-20A-02 R728-20A-02E R728-20A-04 R728-20A-05 R728-20A-05E	2.0	—	M728	E720Q	小	RE23-A	小	RE27	RF31Q	DP*5#16	G155	G403	G305
R728-20A-10 R728-20A-12 R728-20A-12E		C300M-A1											
R728-20B-00 R728-20B-02 R728-20B-02E R728-20B-04 R728-20B-05 R728-20B-05E	2.0	—	M728	E720Q	大	RE23Q-A	大	RE29					
R728-20B-10 R728-20B-12 R728-20B-12E		C300M-A1											

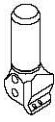
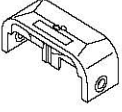
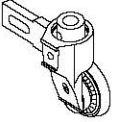
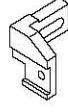
													
MODEL	NEEDLE GAUGE SIZE	OPERATING PANEL	NEEDLE CLAMP	NEEDLE PLATE	PRESSER FOOT ASM	ROLLER HOLDER BRACKET	NEEDLE GUARD	NEEDLE	HOOK ASM	BOBBIN CAP	BOBBIN		
機型	針幅	操作盒	針座	針板	輪錢組	滾輪支座	頂針片	針號	梭頭	梭帽	梭子		
R728-24-00 R728-24-02 R728-24-02E R728-24-04 R728-24-05 R728-24-05E	2.4	—	M728	E724Q	中	RE23P-A	中	RE36					
R728-24-10 R728-24-12 R728-24-12E		C300M-A1											
R728-24A-00 R728-24A-02 R728-24A-02E R728-24A-04 R728-24A-05 R728-24A-05E	2.4	—	M728	E724Q	小	RE23-A	小	RE27	RF31T	DP*5#16	G155	G403	G305
R728-24A-10 R728-24A-12 R728-24A-12E		C300M-A1											
R728-24B-00 R728-24B-02 R728-24B-02E R728-24B-04 R728-24B-05 R728-24B-05E	2.4	—	M728	E724Q	大	RE23Q-A	大	RE29					
R728-24B-10 R728-24B-12 R728-24B-12E		C300M-A1											

# 規格件表 CONVERSION CHART-6

																				
MODEL	NEEDLE GAUGE SIZE	OPERATING PANEL	NEEDLE CLAMP	NEEDLE PLATE	PRESSER FOOT ASM		ROLLER HOLDER BRACKET		NEEDLE	HOOK ASM	BOBBIN CAP	BOBBIN								
機 型	針 幅	操作盒	針 座	針 板	輪錢組		滾輪支座		針 號	梭 頭	梭 帽	梭 子								
R728-224-00 R728-224-02 R728-224-02E R728-224-04 R728-224-05 R728-224-05E	2.4	—	M728	E724T	中	RE23P-A	中	RE36	DP*5#16	G155	G403	G305								
R728-224-10 R728-224-12 R728-224-12E		C300M-A1																		
R728-224A-00 R728-224A-02 R728-224A-02E R728-224A-04 R728-224A-05 R728-224A-05E	2.4	—	M728	E724T	小	RE23-A	小	RE27					DP*5#16	G155	G403	G305				
R728-224A-10 R728-224A-12 R728-224A-12E		C300M-A1																		
R728-224B-00 R728-224B-02 R728-224B-02E R728-224B-04 R728-224B-05 R728-224B-05E	2.4	—	M728	E724T	大	RE23Q-A	大	RE29									DP*5#16	G155	G403	G305
R728-224B-10 R728-224B-12 R728-224B-12E		C300M-A1																		





# PARTS LIST FOR RB GROUP

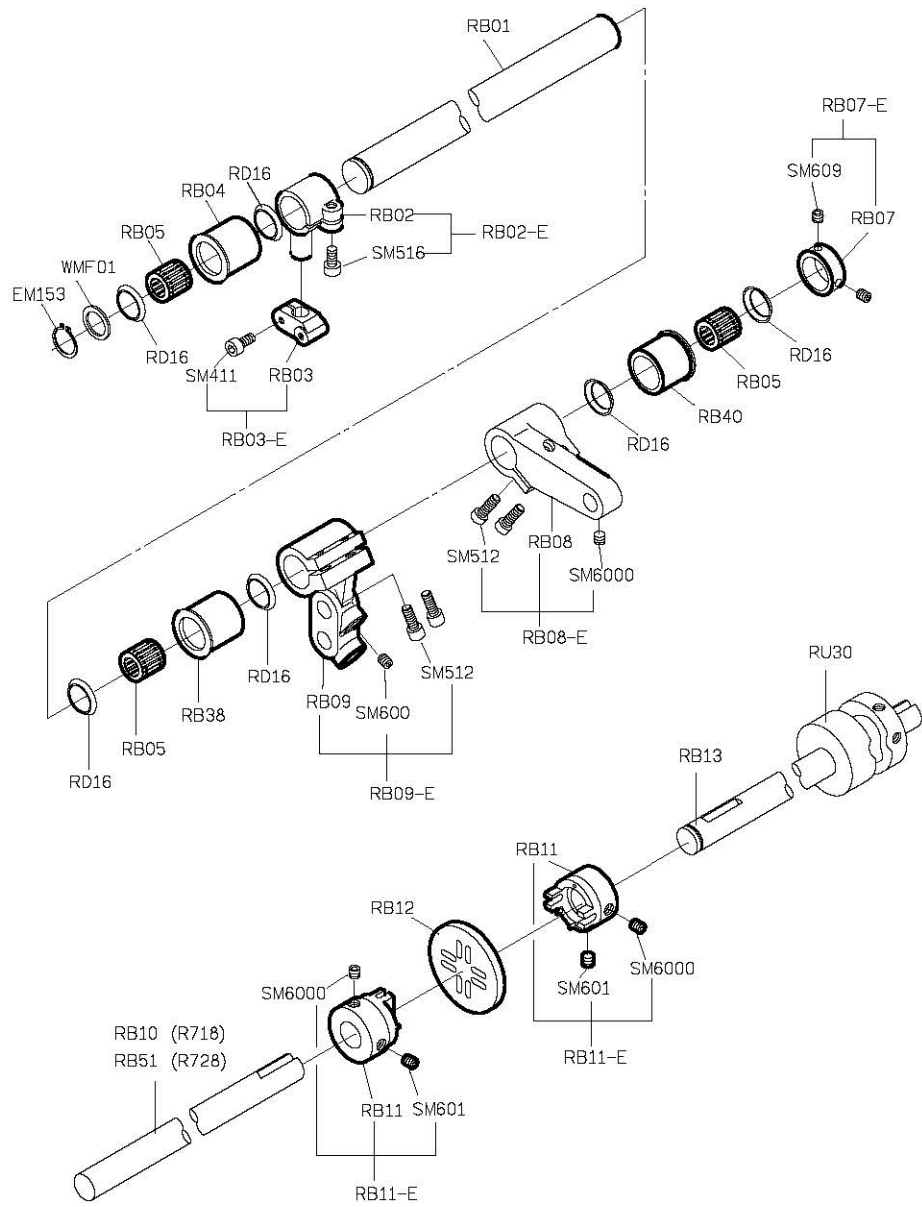

# PARTS LIST FOR RB GROUP

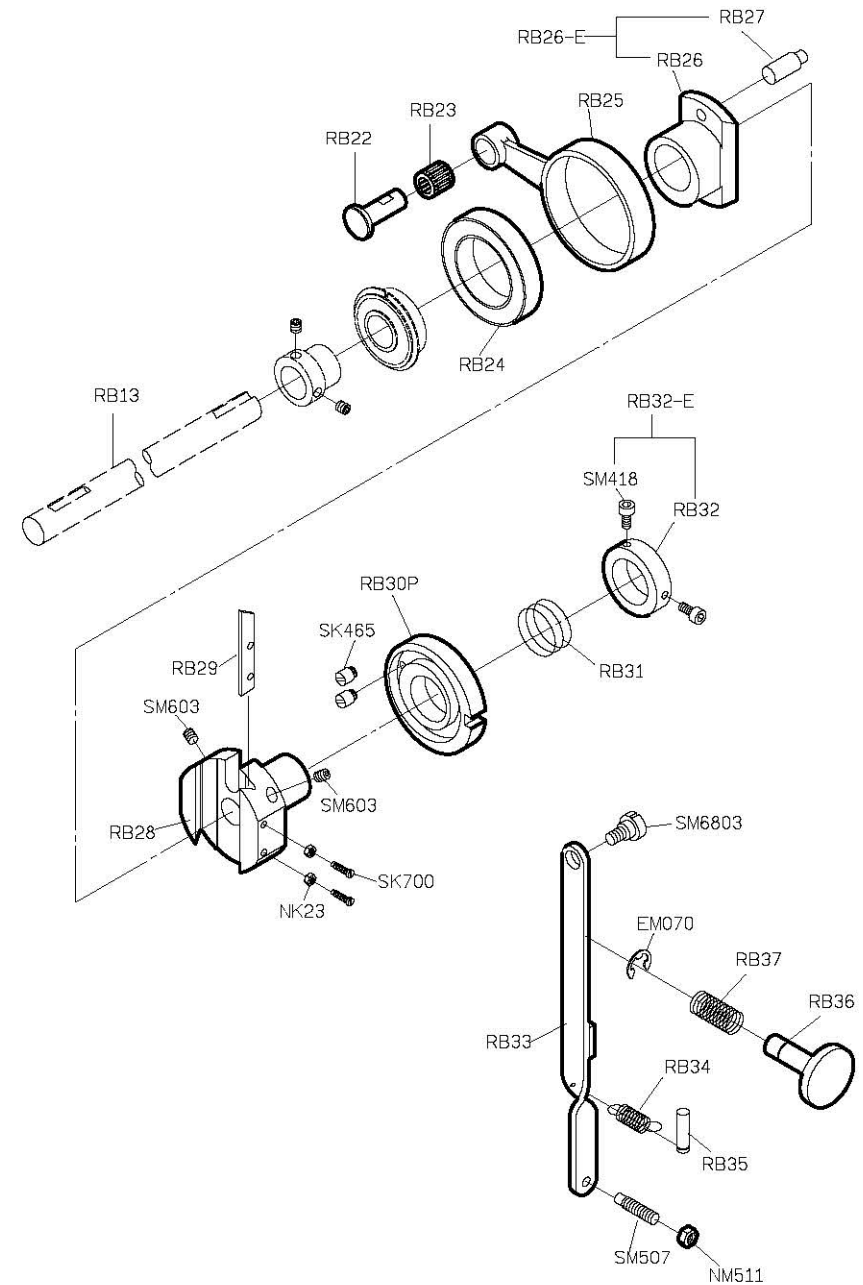





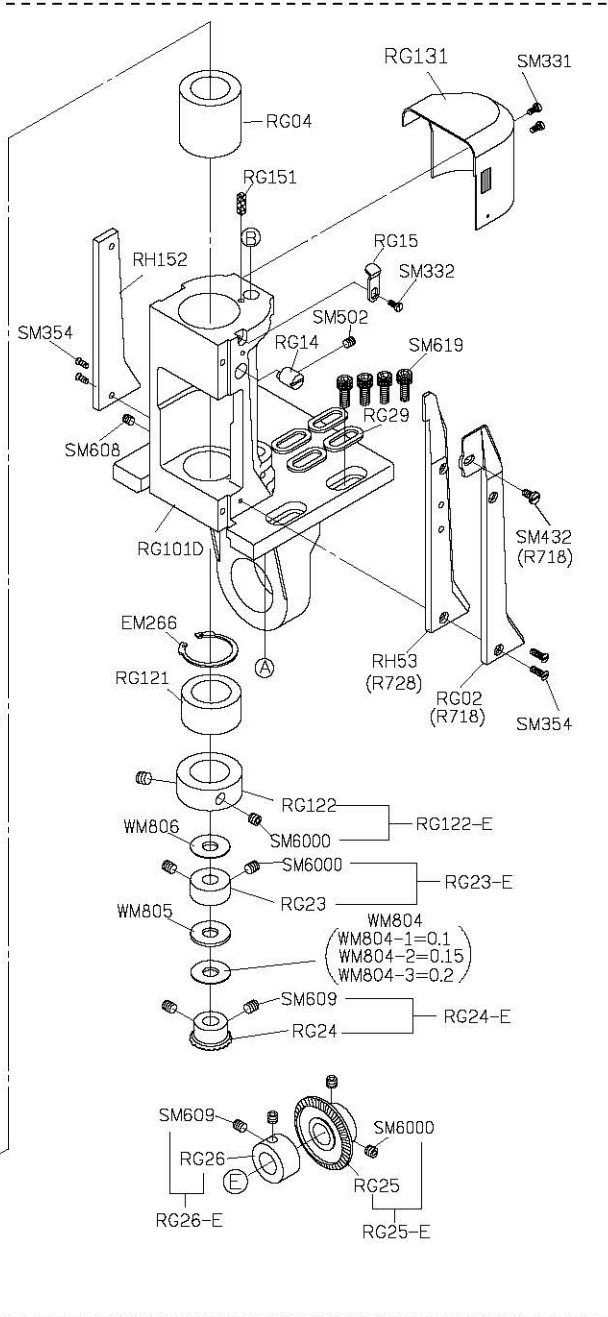
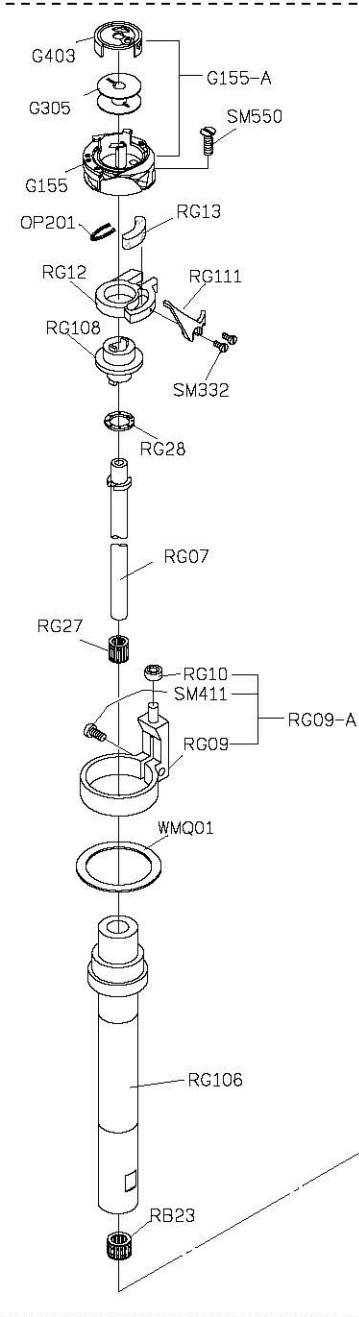
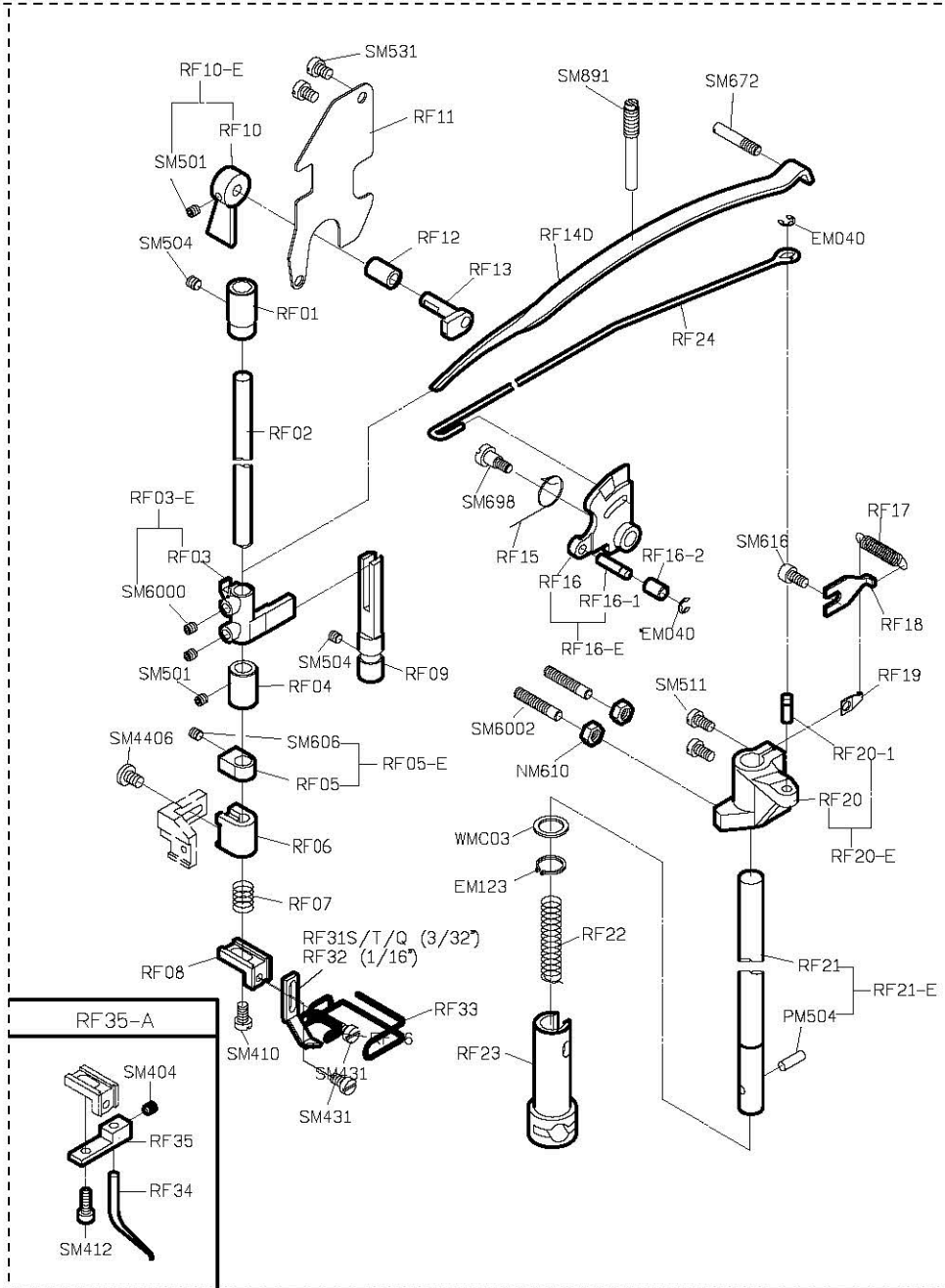

# PARTS LIST FOR RH GROUP

# PARTS LIST FOR RH GROUP

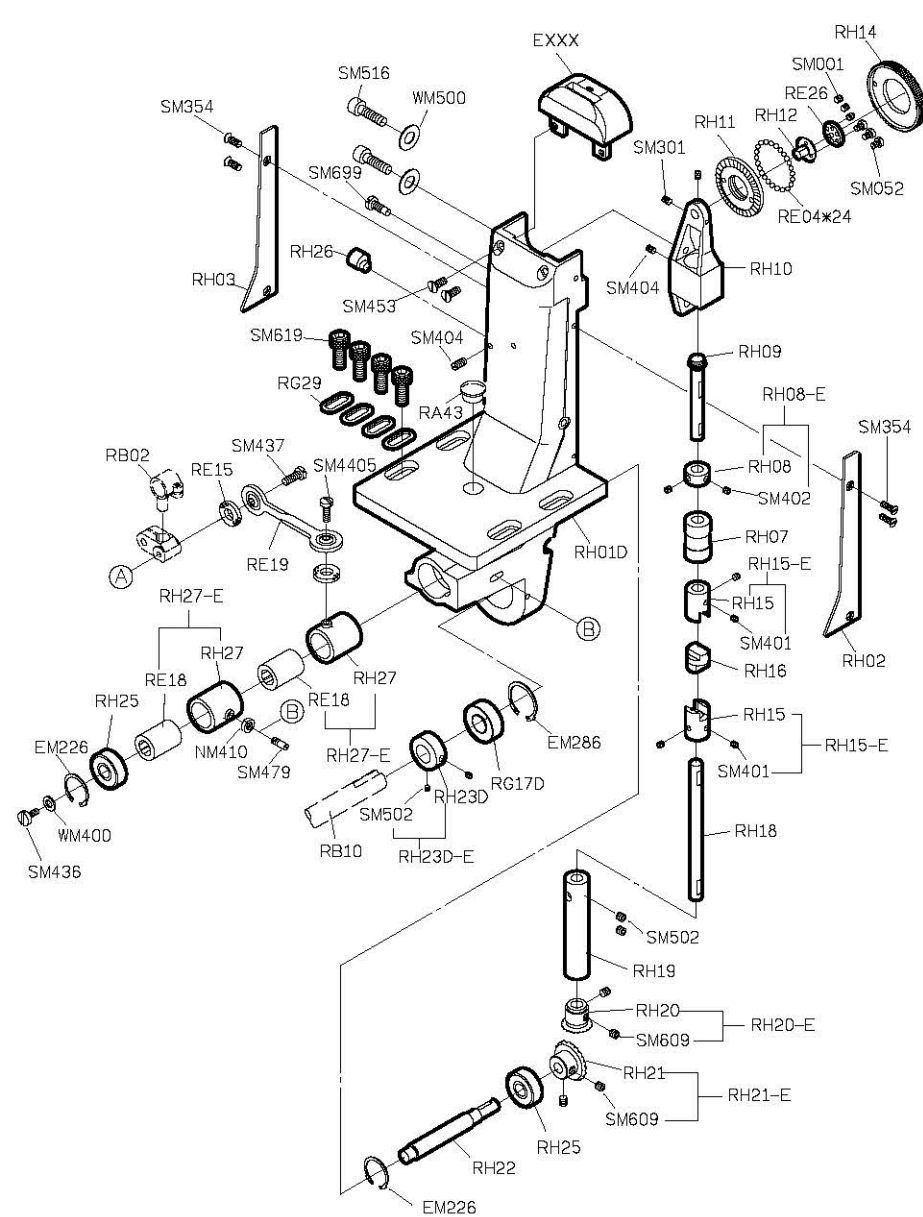
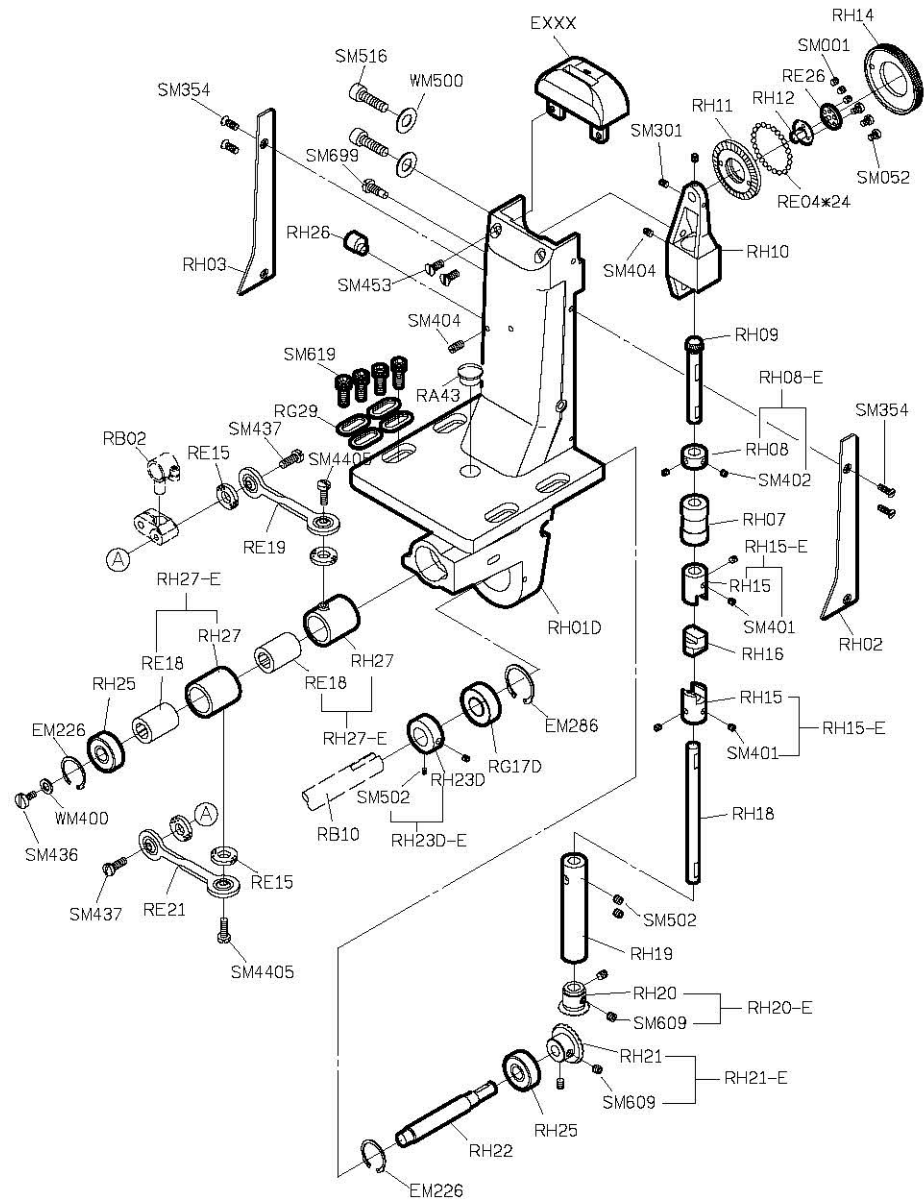





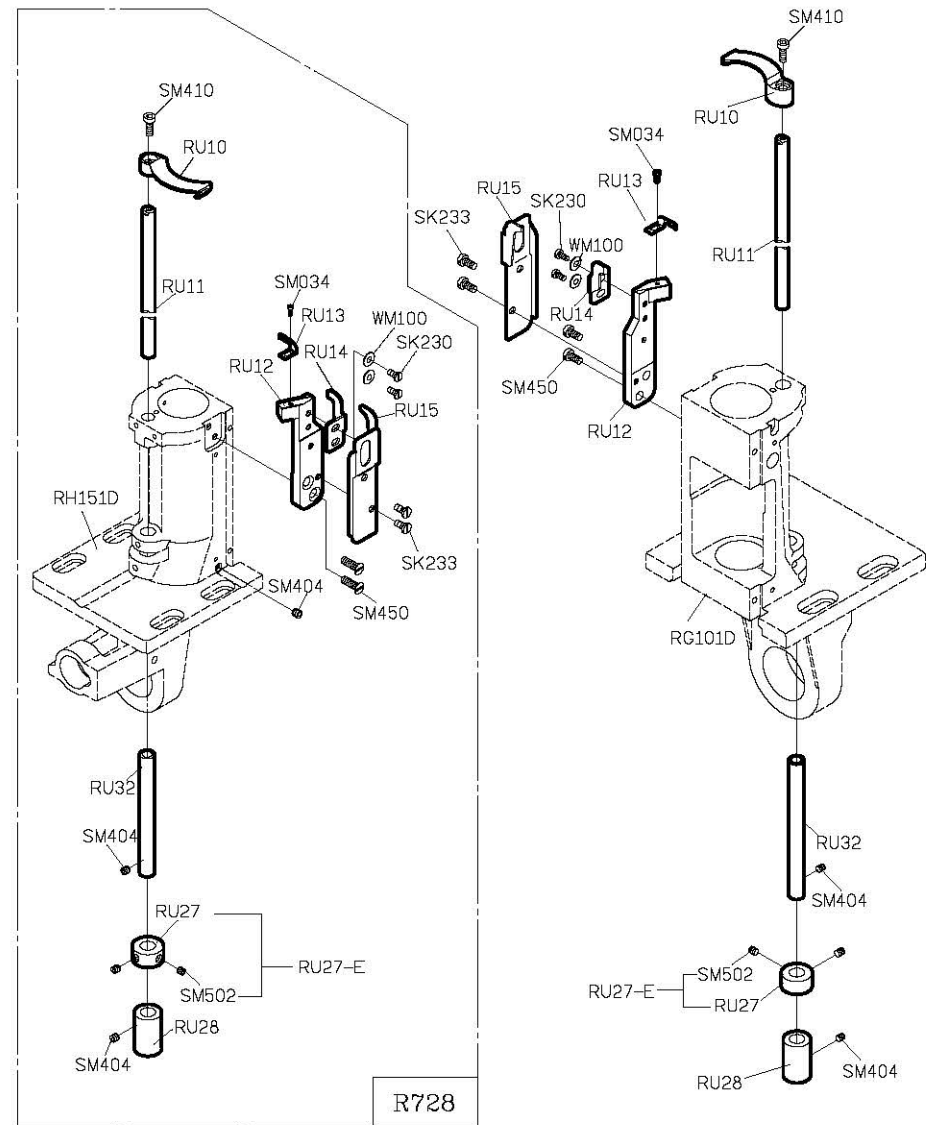
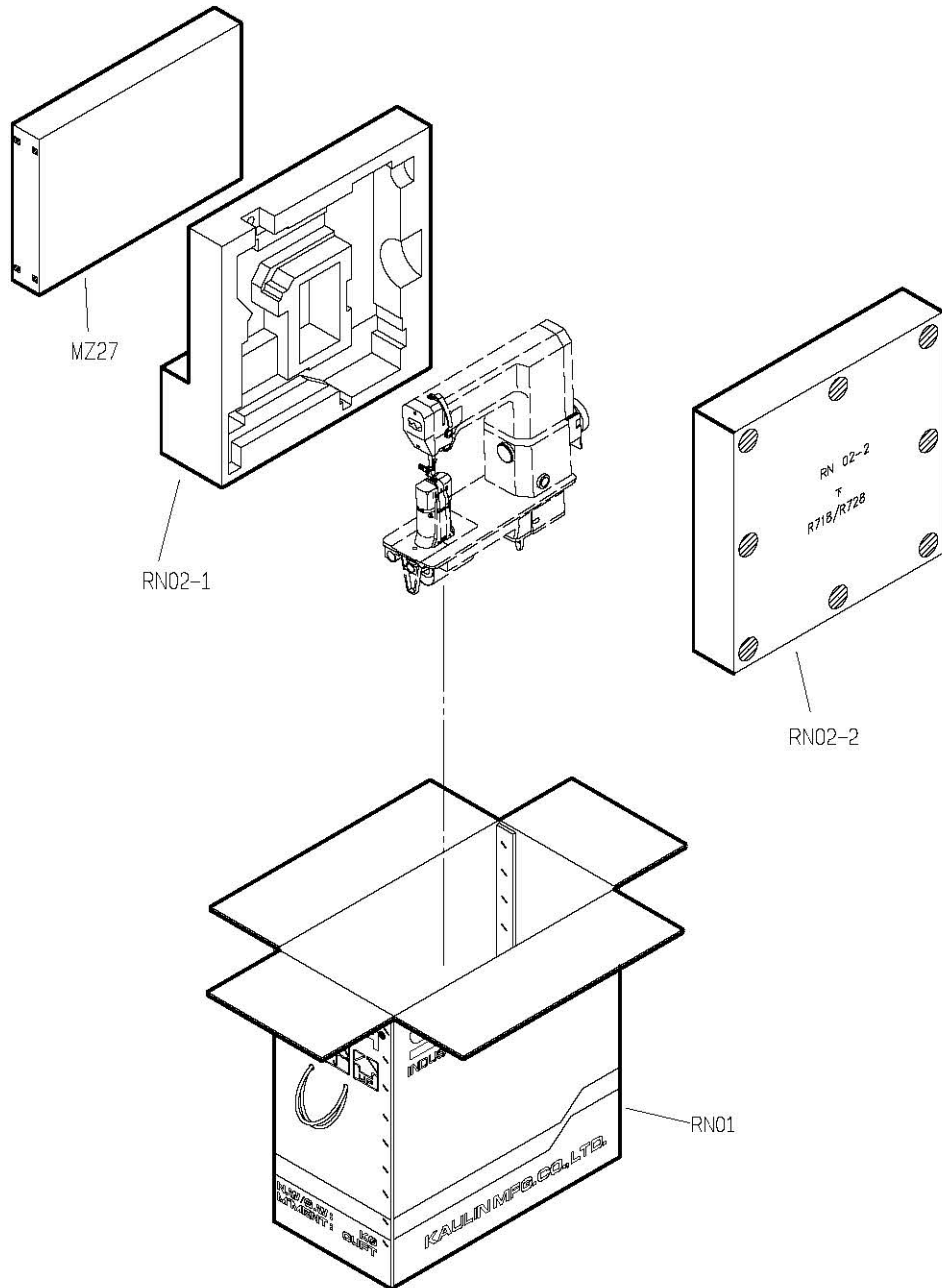



# PARTS LIST FOR RU GROUP

# PARTS LIST FOR THREAD STAND GROUP

PY11-3

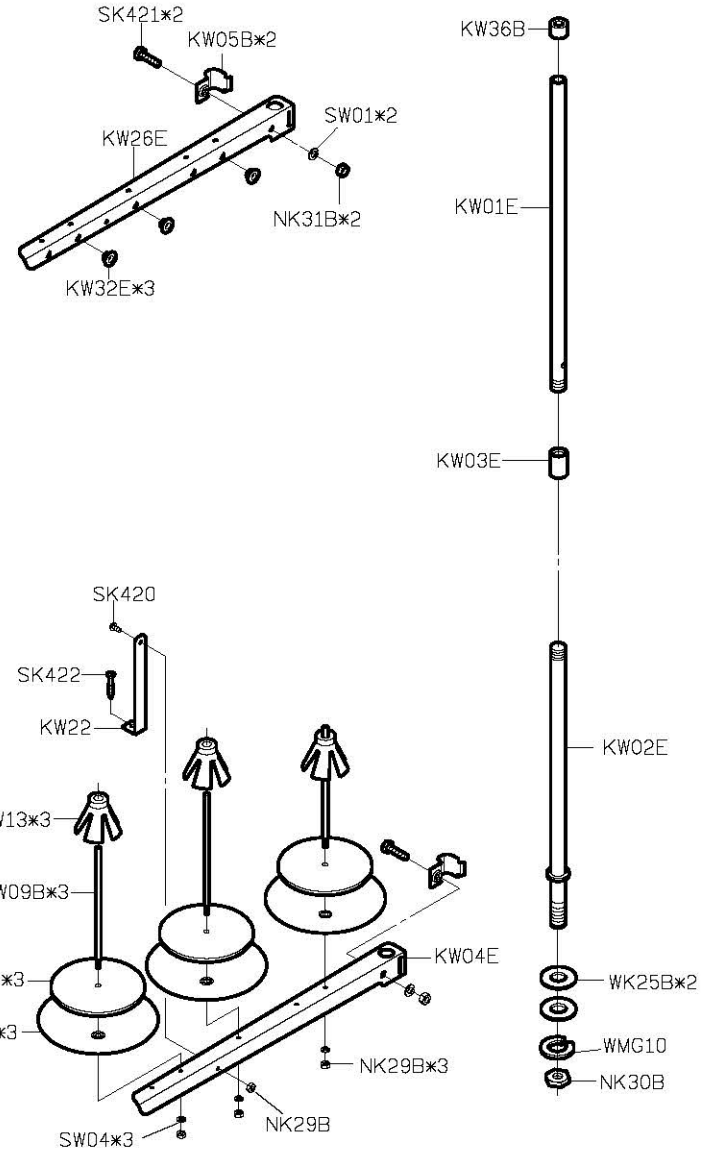
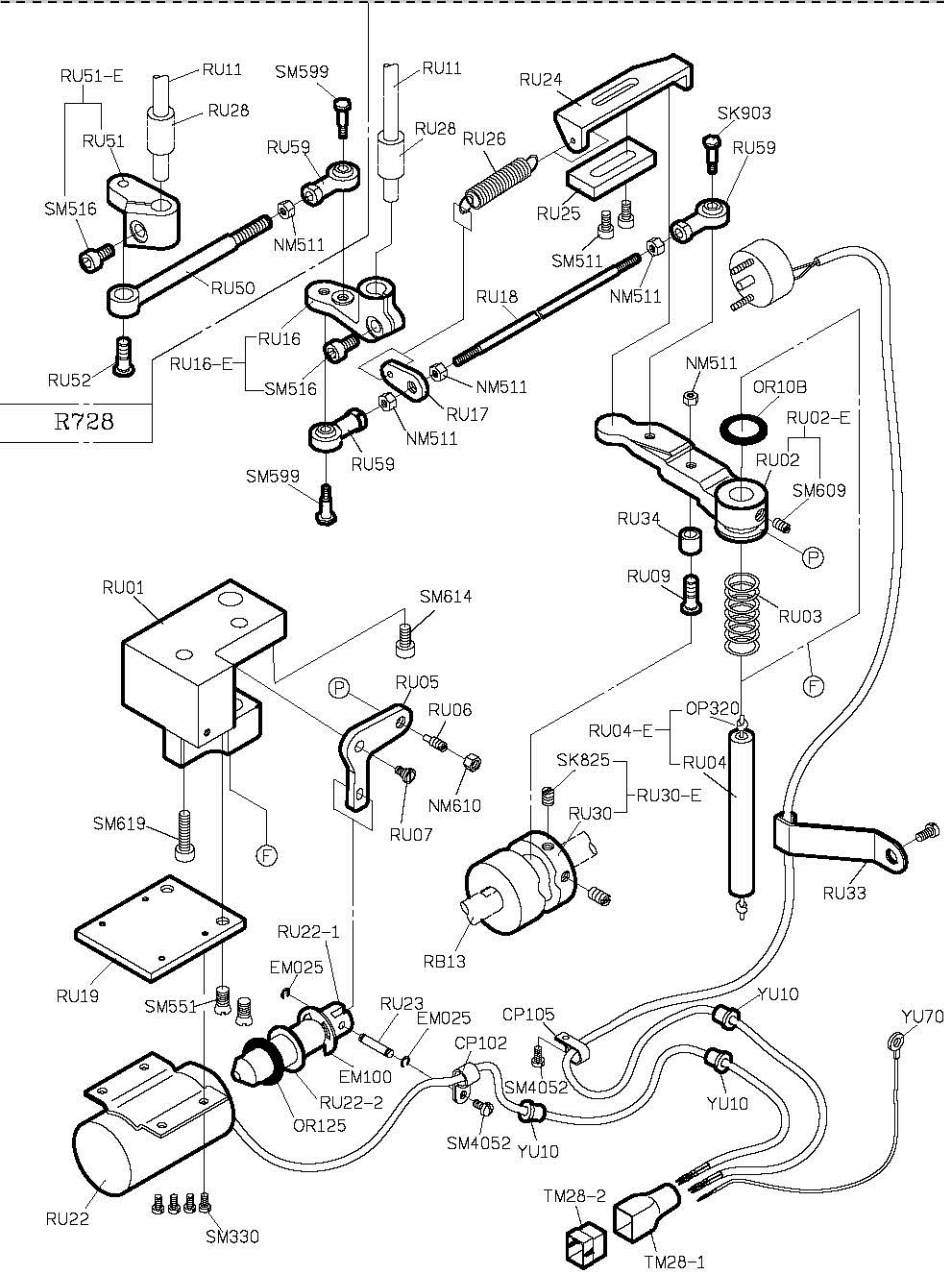



**R718** WITH  
TRIMMER

**R728** WITH  
TRIMMER

高林股份有限公司 KAULIN MFG. CO., LTD.