

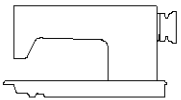
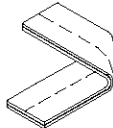
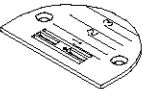
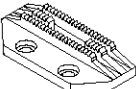
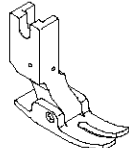
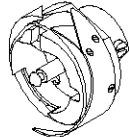
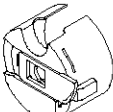

<b>SIRUBA</b> GAGE PARTS LIST	Series	Remark	Page	Date
	<b>L819</b>	<b>-X1 / -X2</b>	1 / 1	2012/11/01

L819規格件表 CONVERSION CHART

								
MODEL	SUB-CLASS	NEEDLE PLATE	FEED DOG	PRESSER FOOT	HOOK ASM	BOBBIN CASE ASM	BOBBIN	NEEDLE
機 型	規 格	針 板	送 具	押 具	梭 頭	梭 殼	梭 子	針 號
L819-X1	厚布料 至 特厚布料	E702	D702	P711/P712	G112	G201	G301	DBX1#21
L819-X2		E702	D702	P711/P712	G131	G204	G304	DBX1#21

<b>SIRUBA</b> MODEL COMPARE LIST	<b>Series</b>	<b>Remark</b>	<b>Page</b>	<b>Date</b>
	<b>L819/L819U</b>	<b>-X1/-X2</b>	<b>1/2</b>	<b>2012/11/01</b>

### L819/L819U 型別件表

										
MODEL	SUB-CLASS	BAD	THRAD TAKE UP LEVER COVER	THREAD PLATE	THREAD PLATE	THREAD PLATE	THREAD PLATE	MOVABLE KINFE BRACKET	FIXED KINFE	FIXED KINFE
機 型	規 格	機體下座	天秤蓋	導線片	導線片	導線片	導線片	活動刀轉座	固定刀	固定刀
L819 /X1	厚布料	LA101	LA11F	LA34	—	LA125	—	—	—	—
L819 /X2		LA501	LA511	—	YA24	—	YA25	—	—	—
L819-TRIMMER /X1		LA101P	LA11F	LA34	—	LA125	—	LU100D	LU711	—
L819-TRIMMER /X2		LA501P	LA511	—	YA24	—	YA25	LU500	—	LU503

<b>SIRUBA</b> MODEL COMPARE LIST	<b>Series</b>	<b>Remark</b>	<b>Page</b>	<b>Date</b>
	L819/L819U	-X1/-X2	2/2	2012/11/01

## L819/L819U 型別件表

								
MODEL	SUB-CLASS	FIXED KINFE FIXED BRACKET	FIXED KINFE FIXED BRACKET	THRAD TAKE UP LEVER	NEEDLE PLATE	BELT PLATE SPRING	MOVABLE KINFE	
機 型	規 格	固定刀固定座	固定刀固定座	天秤	針線導片	板狀彈簧	活動刀	
L819 /X1	厚布料	—	—	LG113	—	LM08	—	
L819 /X2		—	—	LG513	—	LM26	—	
L819-TRIMMER /X1		LU118D	—	LG113	LU102	—	LU100D	
L819-TRIMMER /X2		—	—	A LU118 B SK718 C LU119	LG513	LU502	—	LU500





SIRUBA PARTS LIST	Series	Parts Group	Subclass / Remark	Page
	L819-X1/X2	LC		1/1
				Date
				2012/11/01

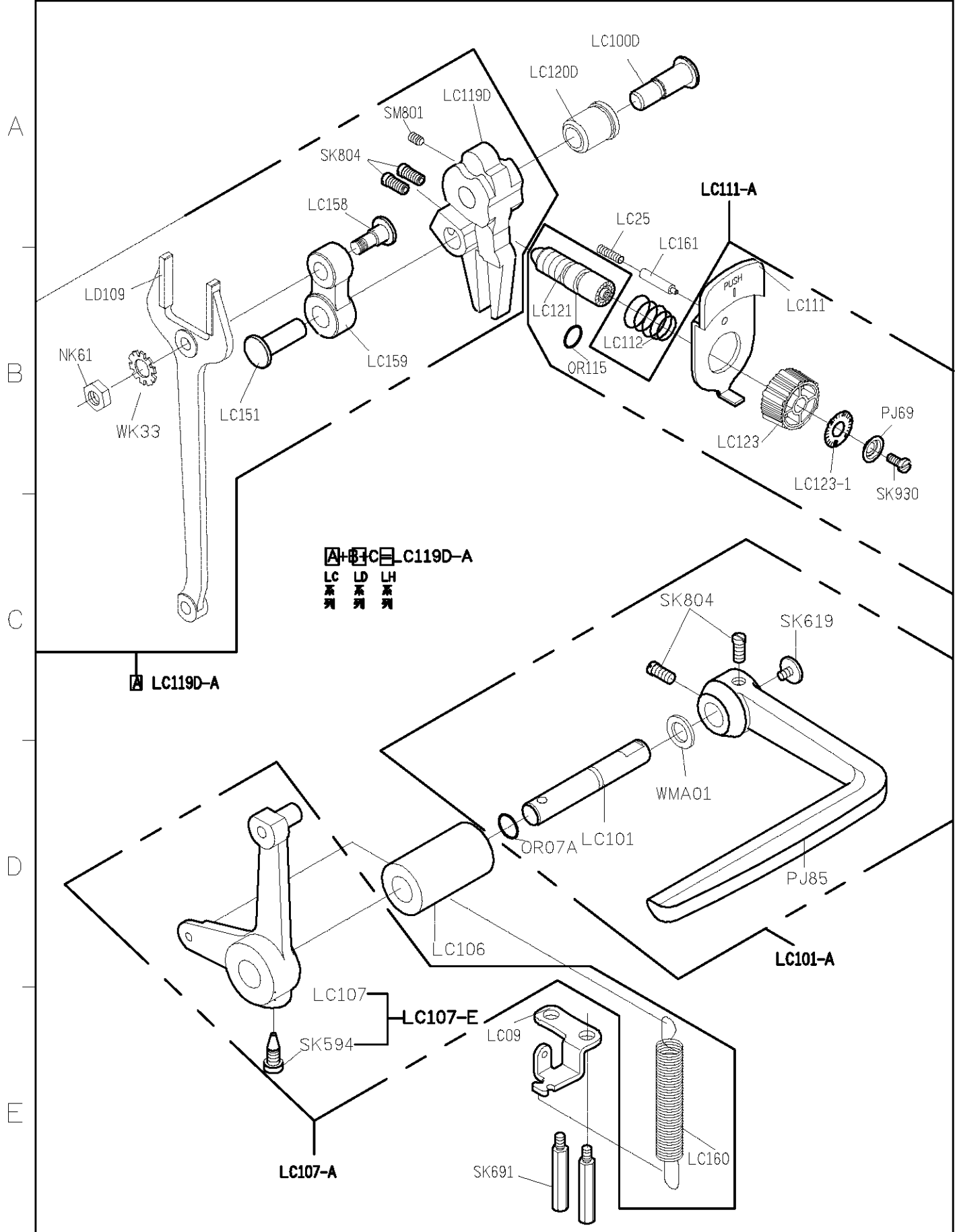



SIRUBA PARTS LIST	Series	Parts Group	Subclass / Remark	Page
	L819-X1/X2	LE		1/1
				Date
				2012/11/01

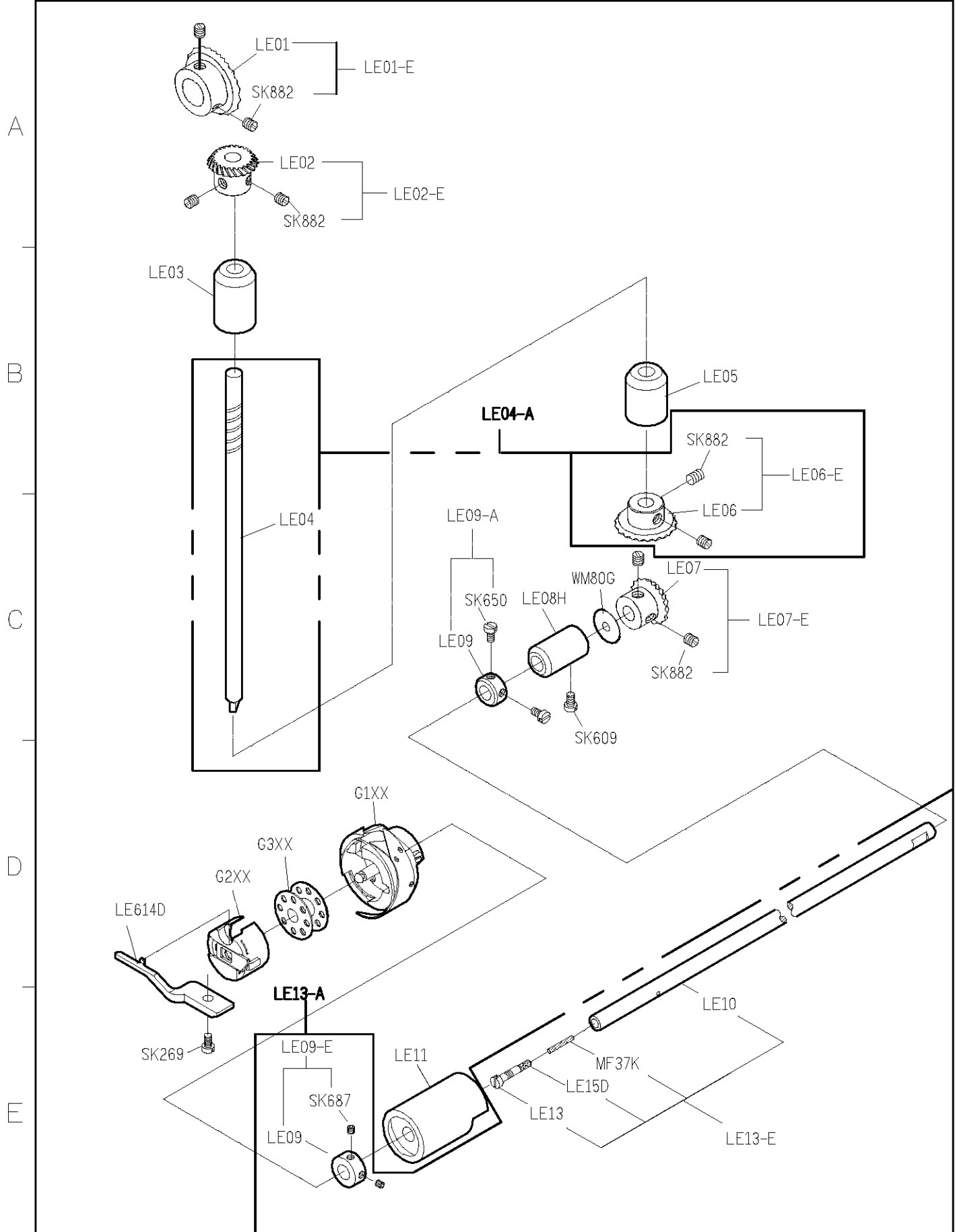



<b>SIRUBA</b> <b>PARTS LIST</b>	<b>Series</b>	<b>Parts Group</b>	<b>Subclass / Remark</b>	<b>Page</b>
	L819-X1/X2	<b>LG</b>	#:Use for X2	1/1
				<b>Date</b>
				2012/11/01

A  
B  
C  
D  
E

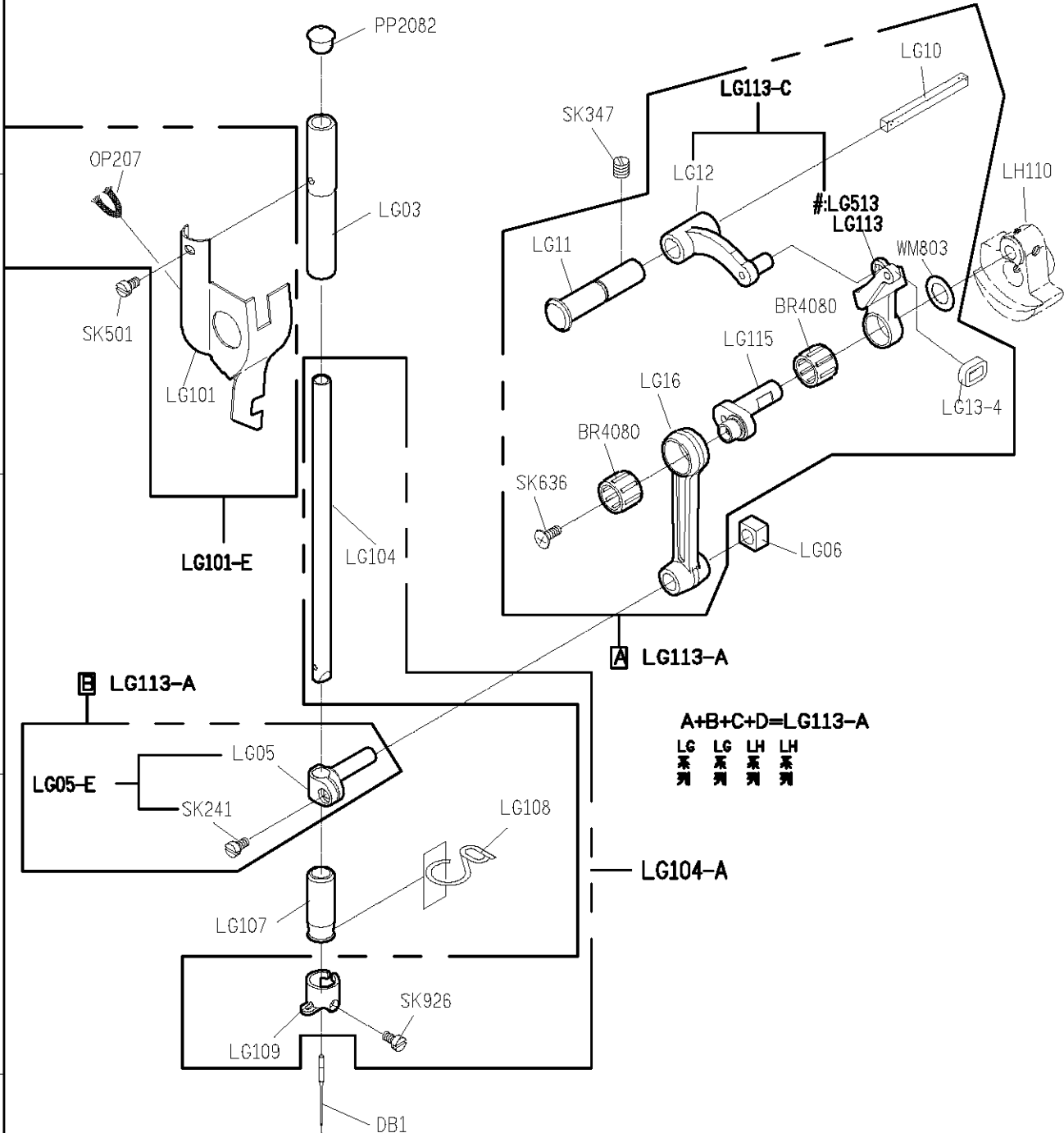

SIRUBA PARTS LIST	Series	Parts Group	Subclass / Remark	Page
	L819-X1/X2	LH		1/1
				Date
				2012/11/01

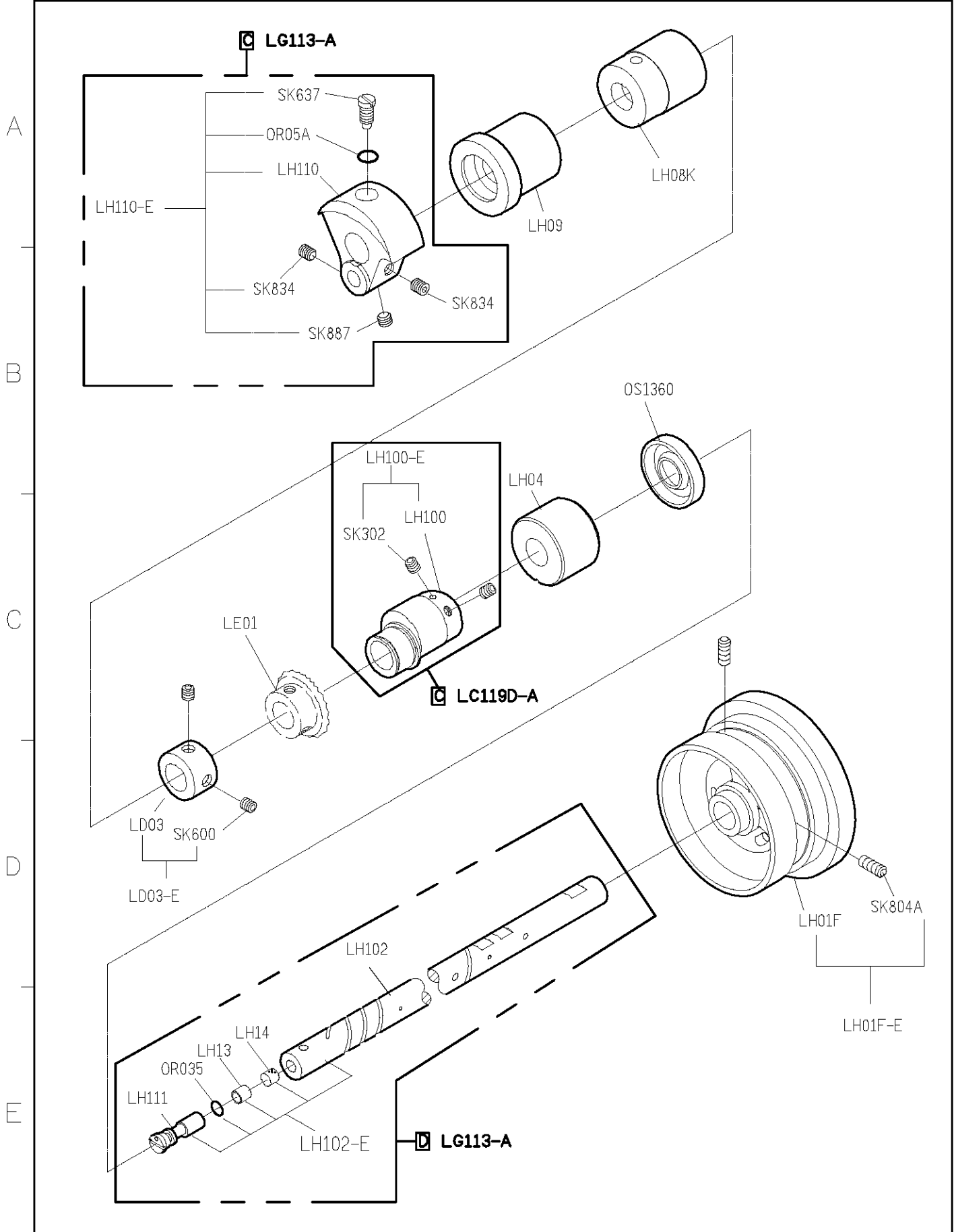





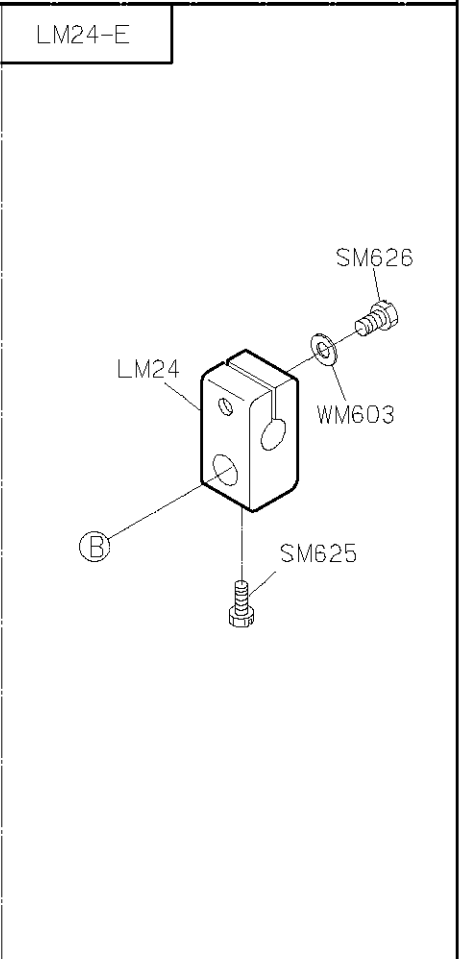
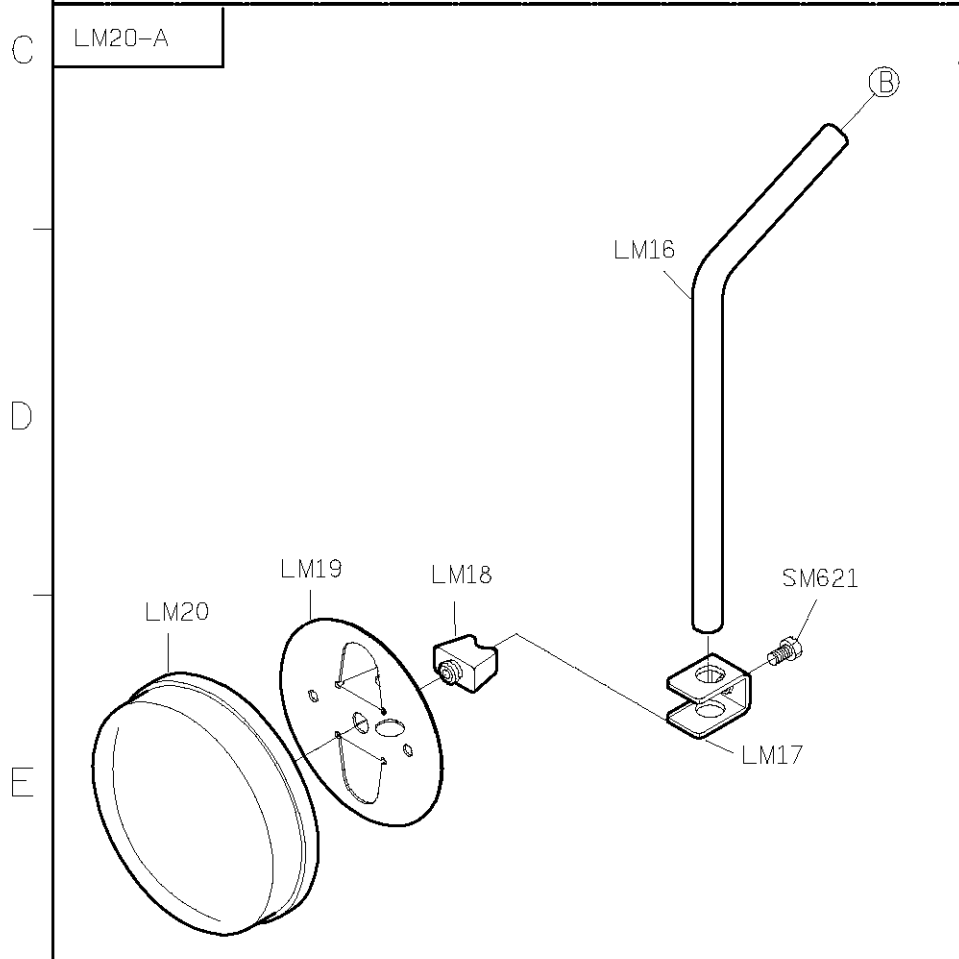
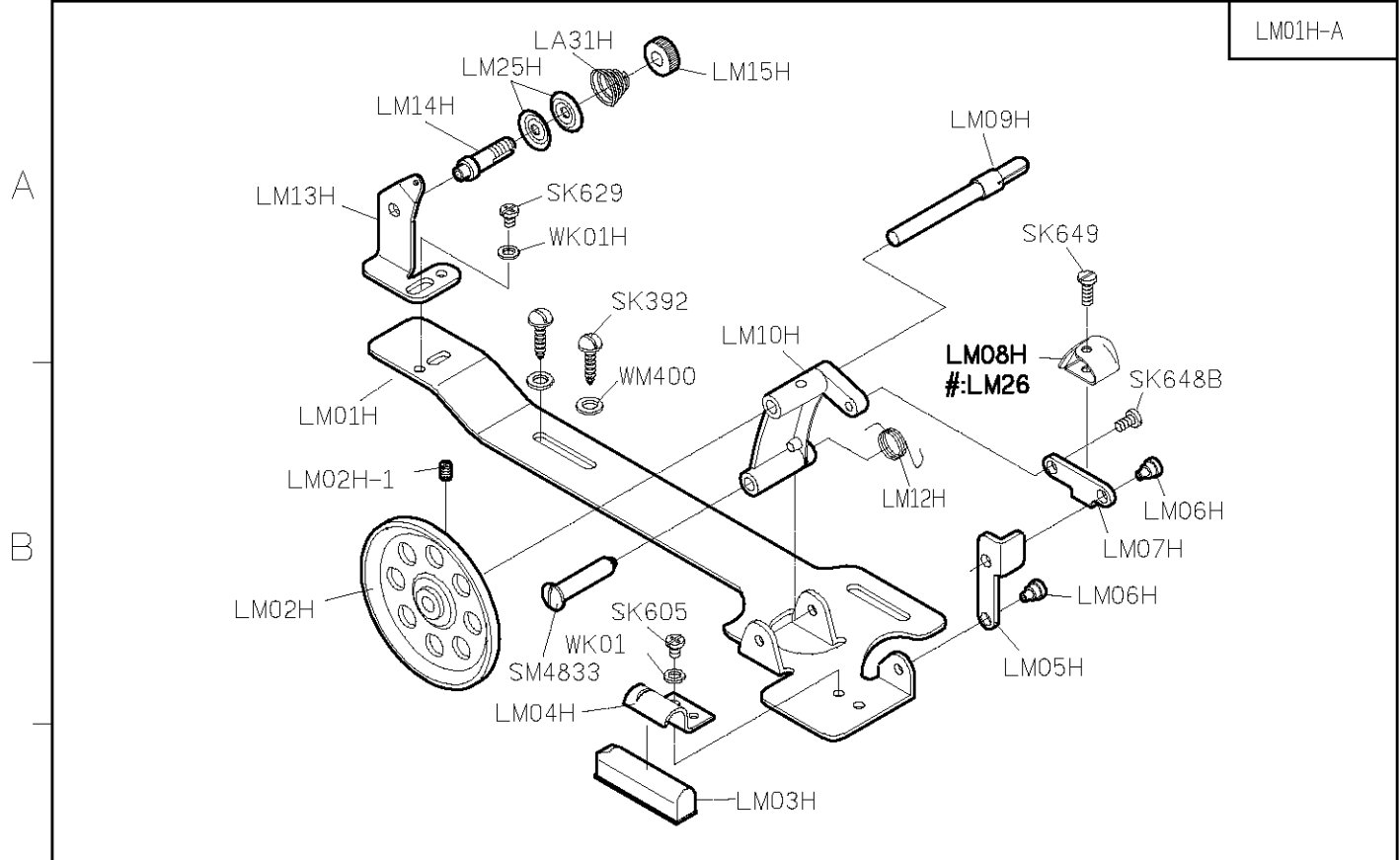



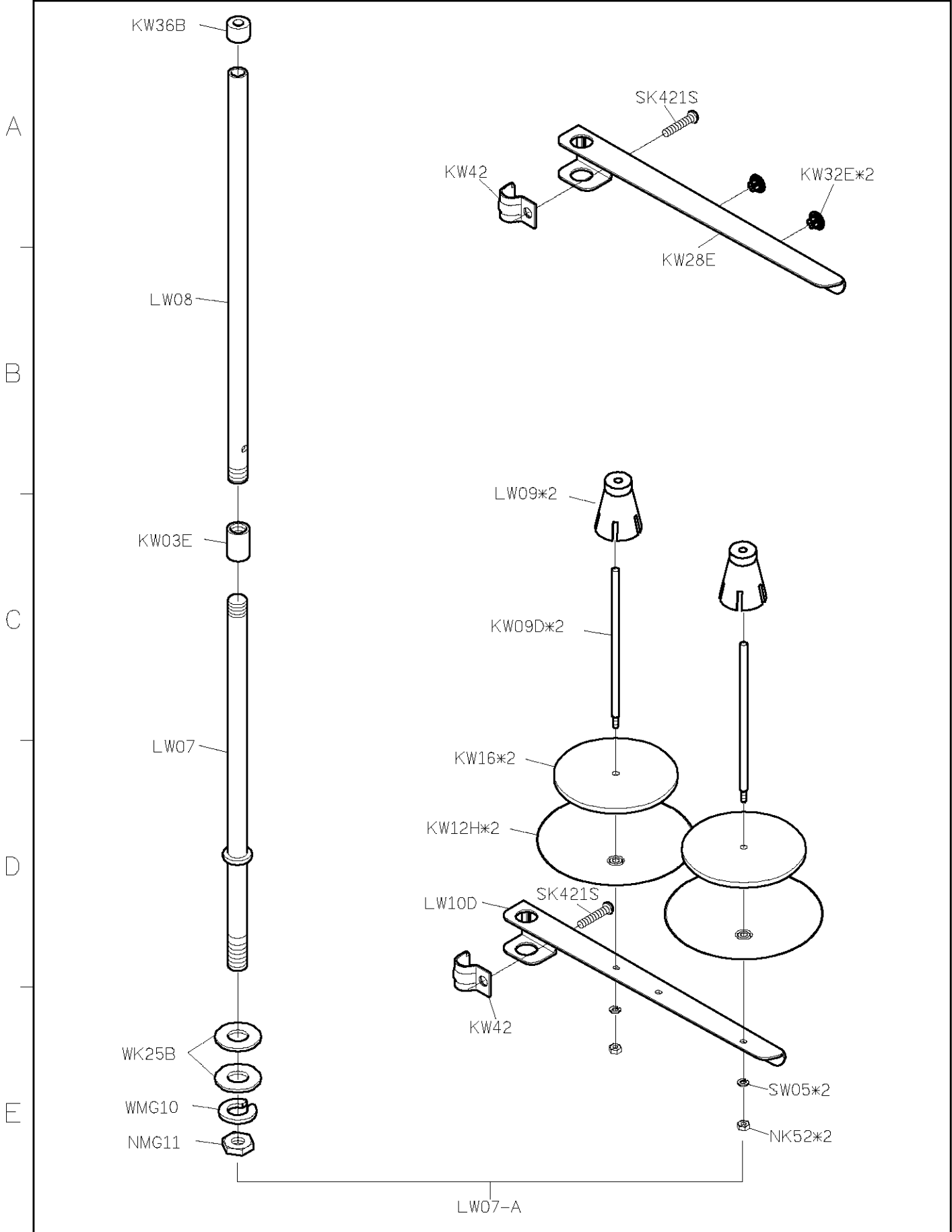

SIRUBA PARTS LIST	Series	Parts Group	Subclass / Remark	Page
	L819-X1/X2	LM	#:Use for X2	1/1
				Date
				2012/11/01

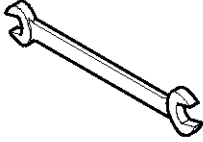
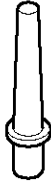
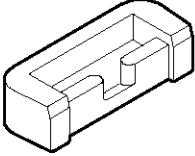
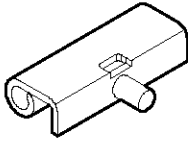
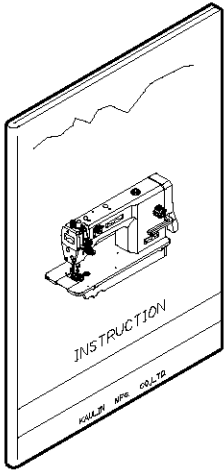
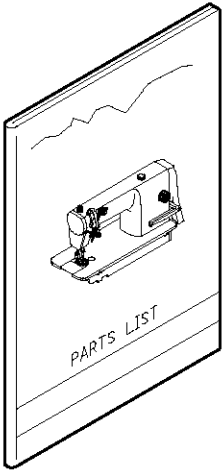
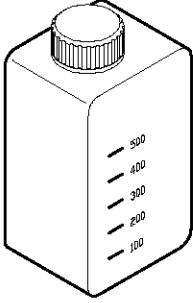

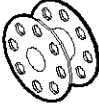
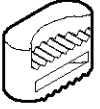
SIRUBA PARTS LIST	Series	Parts Group	Subclass / Remark	Page
	L819/L819U	LW		1/1
				Date
				2013/04/10

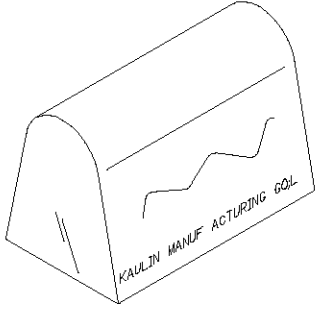
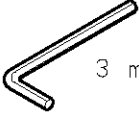

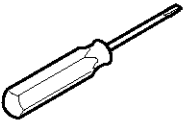
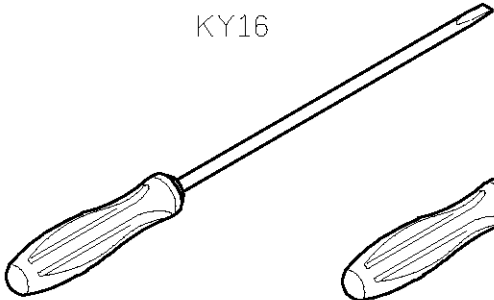
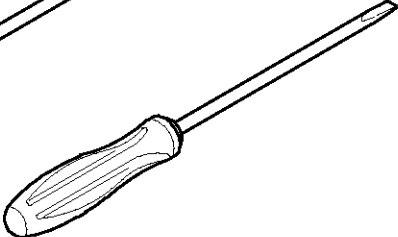
SIRUBA PARTS LIST	Series	Parts Group	Subclass / Remark	Page
	L819-X1/X2	LY		1/1
				Date
				2012/11/01

A	LY01 	LY02 	YM04*2 	LY05*2 
B	LY10 	LY13 	LY37-A 	YM102*2 
C			G3XX*2 	YM103*2 
D	針*2 	MY01 	MY11 	KZ03*1 
E	MY13 	KY16 	KY17 	KY26F 
	1	2	3	4

SIRUBA PARTS LIST	Series	Parts Group	Subclass / Remark	Page
	L819-X1/X2	LZ		1/1
				Date
				2012/11/01

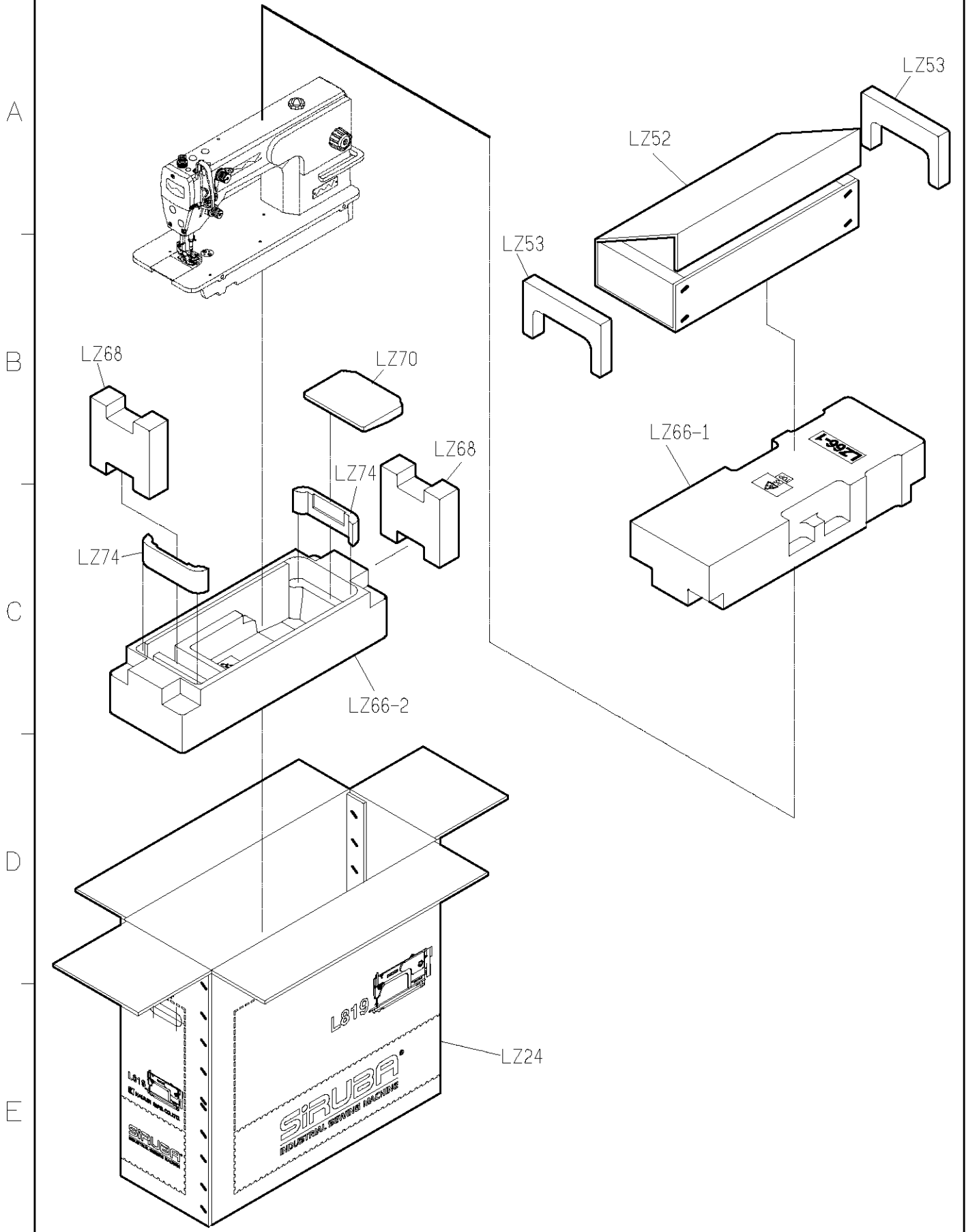

SIRUBA TABLE CUT - OUT	Series	Item Code	Subclass / Remark	Mounting
	L818D/L917	L918-T1		Fully-submerged
	L918/L918U			Date
	L819/L819U			2013/01/01

