

SIRUBA®

銀箭牌工業用縫紉機

INDUSTRIAL SEWING MACHINE

L818F

WITH TRIMMER

零件圖 PARTS LIST







CE





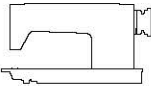
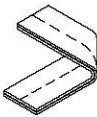

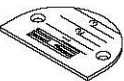
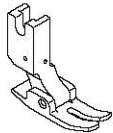
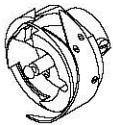
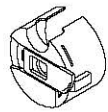
 高林股份有限公司
KAULIN MFG. CO., LTD.

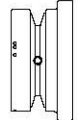
From the library of: Superior Sewing Machine & Supply LLC



										
MODEL	SUB-CLASS	OPERATING PANEL	NEEDLE PLATE	FEED DOG	PRESSER FOOT	HOOK ASM	BOBBIN CASE ASM	BOBBIN	NEEDLE	HAND WHEEL
機 型	規 格	操作盒	針 板	送 具	押 具	梭 頭	梭 殼	梭 子	針 號	皮 帶 輪
L818F-L1-00 ~ L818F-L1-03	薄布料	LA55F-A	E701	D701	P721	G121	G202	G303	DA*1#9	LH01-A
L818F-L1-00A ~ L818F-L1-03A		LA55F-A	E701	D701	P721	G121	G202	G303	DA*1#9	LH01Q-E
L818F-L1-10 ~ L818F-L1-13		LA53G-A	E701	D701	P721	G121	G202	G303	DA*1#9	LH01-A
L818F-L1-K10~ L818F-L1-K13		L600A	E701	D701	P721	G121	G202	G303	DA*1#9	LH01P-A
L818F-M1-00 (L818F-M1B-00) L818F-M1-03 (L818F-M1B-03)	薄中布 至 厚布料	LA55F-A	E704	D701	P701	G121	G202	G303	DB*1#11	LH01-A
L818F-M1-00A (L818F-M1B-00A) L818F-M1-03A (L818F-M1B-03A)		LA55F-A	E704D	D701	P701	G121	G202	G303	DB*1#11	LH01Q-E
L818F-M1A-00 (L818F-M1C-00) L818F-M1A-03 (L818F-M1C-03)		LA55F-A	E704D	D702	P701	G121	G202	G303	DB*1#11	LH01-A
L818F-M1A-00A (L818F-M1C-00A) L818F-M1A-03A (L818F-M1C-03A)		LA55F-A	E704D	D702	P701	G121	G202	G303	DB*1#11	LH01Q-E
L818F-M1-10 (L818F-M1B-10) L818F-M1-13 (L818F-M1B-13)		LA53G-A	E704	D701	P701	G121	G202	G303	DB*1#11	LH01-A
L818F-M1-K10(L818F-M1B-K10) L818F-M1-K13(L818F-M1B-K13)		L600A	E704	D701	P701	G121	G202	G303	DB*1#11	LH01P-A
L818F-M1A-10 (L818F-M1C-10) L818F-M1A-13 (L818F-M1C-13)		LA53G-A	E704D	D702	P701	G121	G202	G303	DB*1#11	LH01-A
L818F-M1A-K10 (L818F-M1C-K10) L818F-M1A-K13 (L818F-M1C-K13)		L600A	E704D	D702	P701	G121	G202	G303	DB*1#11	LH01P-A

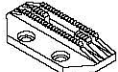
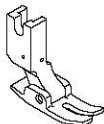
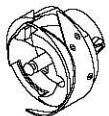
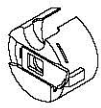

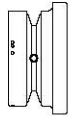



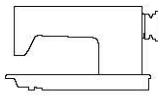
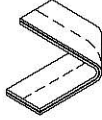
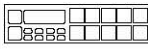
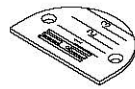
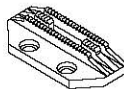
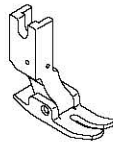
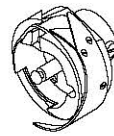
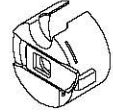
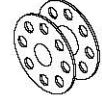

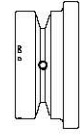







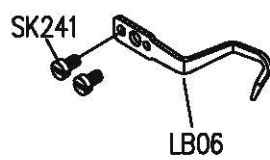

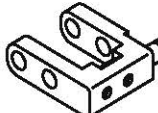
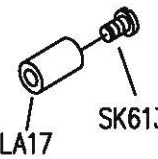





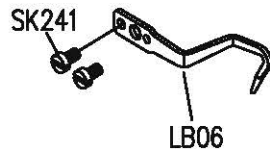

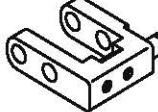
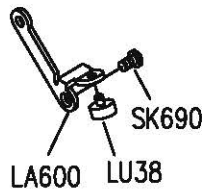





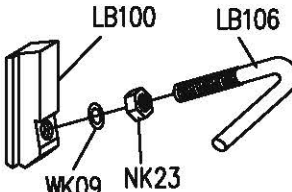

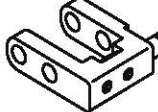



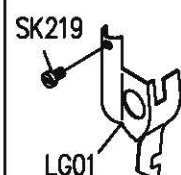
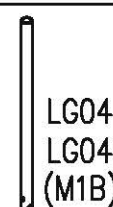
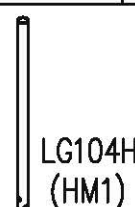















規格件表 CONVERSION CHART-2

										
MODEL	SUB-CLASS	OPERATING PANEL	NEEDLE PLATE	FEED DOG	PRESSER FOOT	HOOK ASM	BOBBIN CASE ASM	BOBBIN	NEEDLE	HAND WHEEL
機 型	規 格	操作盒	針 板	送 具	押 具	梭 頭	梭 殼	梭 子	針 號	皮帶輪
L818F-HM1-00 L818F-HM1-03	薄中布 至 厚布料	LA55F-A	E704	D701	P701	G121	G202	G303	DB*1#11	LH01-A
L818F-HM1A-00 L818F-HM1A-03		LA55F-A	E704D	D702	P701	G121	G202	G303	DB*1#11	LH01-A
L818F-HM1-10 L818F-HM1-13		LA53G-A	E704	D701	P701	G121	G202	G303	DB*1#11	LH01-A
L818F-HM1-K10 L818F-HM1-K13		L600A	E704	D701	P701	G121	G202	G303	DB*1#11	LH01P-A
L818F-HM1A-10 L818F-HM1A-13		LA53G-A	E704D	D702	P701	G121	G202	G303	DB*1#11	LH01-A
L818F-HM1A-K10 L818F-HM1A-K13		L600A	E704D	D702	P701	G121	G202	G303	DB*1#11	LH01P-A

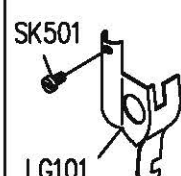
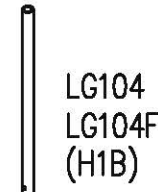













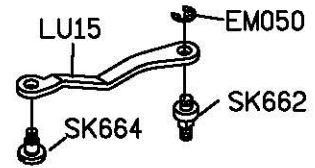

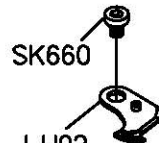



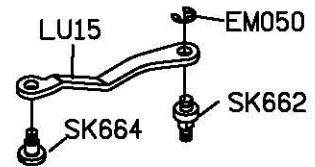

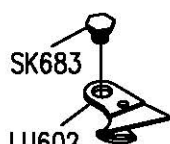

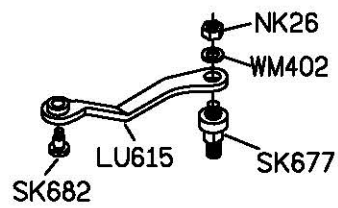
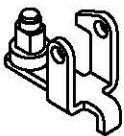

										
MODEL	SUB-CLASS	OPERATING PANEL	NEEDLE PLATE	FEED DOG	PRESSER FOOT	HOOK ASM	BOBBIN CASE ASM	BOBBIN	NEEDLE	HAND WHEEL
機 型	規 格	操作盒	針 板	送 具	押 具	梭 頭	梭 殼	梭 子	針 號	皮 帶 輪
L818F-H1-00 (L818F-H1B-00) L818F-H1-03 (L818F-H1B-03)	中厚布 至 厚布料	LA55F-A	E711	D711	P711	G122J	G202	G303	DB*1#21	LH01-A
L818F-H1-00A (L818F-H1B-00A) L818F-H1-03A (L818F-H1B-03A)		LA55F-A	E711D	D711D	P711D	G122J	G202	G303	DB*1#21	LH01Q-E
L818F-H1A-00 (L818F-H1C-00) L818F-H1A-03 (L818F-H1C-03)		LA55F-A	E711D	D711D	P711D	G122J	G202	G303	DB*1#21	LH01-A
L818F-H1A-00A (L818F-H1C-00A) L818F-H1A-03A (L818F-H1C-03A)		LA55F-A	E711D	D711D	P711D	G122J	G202	G303	DB*1#21	LH01Q-E
L818F-H1-10 (L818F-H1B-10) L818F-H1-13 (L818F-H1B-13)		LA53G-A	E711	D711	P711	G122J	G202	G303	DB*1#21	LH01-A
L818F-H1-K10 (L818F-H1B-K10) L818F-H1-K13 (L818F-H1B-K13)		L600A	E711	D711	P711	G122J	G202	G303	DB*1#21	LH01P-A
L818F-H1A-10 (L818F-H1C-10) L818F-H1A-13 (L818F-H1C-13)		LA53G-A	E711D	D711D	P711D	G122J	G202	G303	DB*1#21	LH01-A
L818F-H1A-K10 (L818F-H1C-K10) L818F-H1A-K13 (L818F-H1C-K13)		L600A	E711D	D711D	P711D	G122J	G202	G303	DB*1#21	LH01P-A

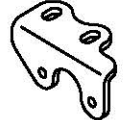
規格件表 CONVERSION CHART-4

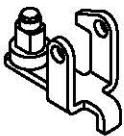
										
MODEL	SUB-CLASS	OPERATING PANEL	NEEDLE PLATE	FEED DOG	PRESSER FOOT	HOOK ASM	BOBBIN CASE ASM	BOBBIN	NEEDLE	HAND WHEEL
機 型	規 格	操作盒	針 板	送 具	押 具	梭 頭	梭 殼	梭 子	針 號	皮 帶 輪
L818F-F1-00 ? L818F-F1-03	超 薄 布 料	LA55F-A	E731	D731	P721	G113	G202	G303	DB*1SF#9	LH01-A
L818F-F1-00A ? L818F-F1-03A		LA55F-A	E731	D731	P721	G113	G202	G303	DB*1SF#9	LH01Q-E
L818F-F1-10 ? L818F-F1-13		LA53G-A	E731	D731	P721	G113	G202	G303	DB*1SF#9	LH01-A
L818F-F1-K10 ? L818F-F1-K13		L600A	E731	D731	P721	G113	G202	G303	DB*1SF#9	LH01P-A
L818F-F1-20 ? L818F-F1-23		LA55F-A	E721	D721	P721	G113	G202	G303	DB*1SF#9	LH01-A
L818F-F1-20A ? L818F-F1-23A		LA55F-A	E721	D721	P721	G113	G202	G303	DB*1SF#9	LH01Q-E
L818F-F1-30 ? L818F-F1-33		LA53G-A	E721	D721	P721	G113	G202	G303	DB*1SF#9	LH01-A
L818F-K1-00 ? L818F-K1-03		編 織 布 料	LA55F-A	E741	D741	P721	G121	G202	G303	DB*1#9
L818F-K1-00A ? L818F-K1-03A	LA55F-A		E741	D741	P721	G121	G202	G303	DB*1#9	LH01Q-E
L818F-K1-10 ? L818F-K1-13	LA53G-A		E741	D741	P721	G121	G202	G303	DB*1#9	LH01-A
L818F-K1-K10 ? L818F-K1-K13	L600A		E741	D741	P721	G121	G202	G303	DB*1#9	LH01P-A

M1												
L1												
H1												
M1												
L1												
H1												

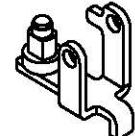
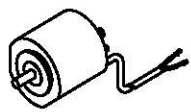
型別件對照表 MODEL COMPARE LIST-2

M1 HM1	 LU01	 SK660 LU02	 LU03	 LU04	 LU05	 LU15 EM050 SK664 SK662
L1	 LU01	 SK660 LU02	 LU03	 LU04	 LU05	 LU15 EM050 SK664 SK662
H1	 LU601	 SK683 LU602	 LU603	 LU604	 LU605	 NK26 WM402 SK677 LU615 SK682
M1 HM1	 LU18	 LU25	 LU26	 LU28		
L1	 LU18	 LU25	 LU26	 LU28		
H1	 LU618	 LU625	 LU626	 LU628		

PARTS LIST FOR LC GROUP

PARTS LIST FOR LD GROUP

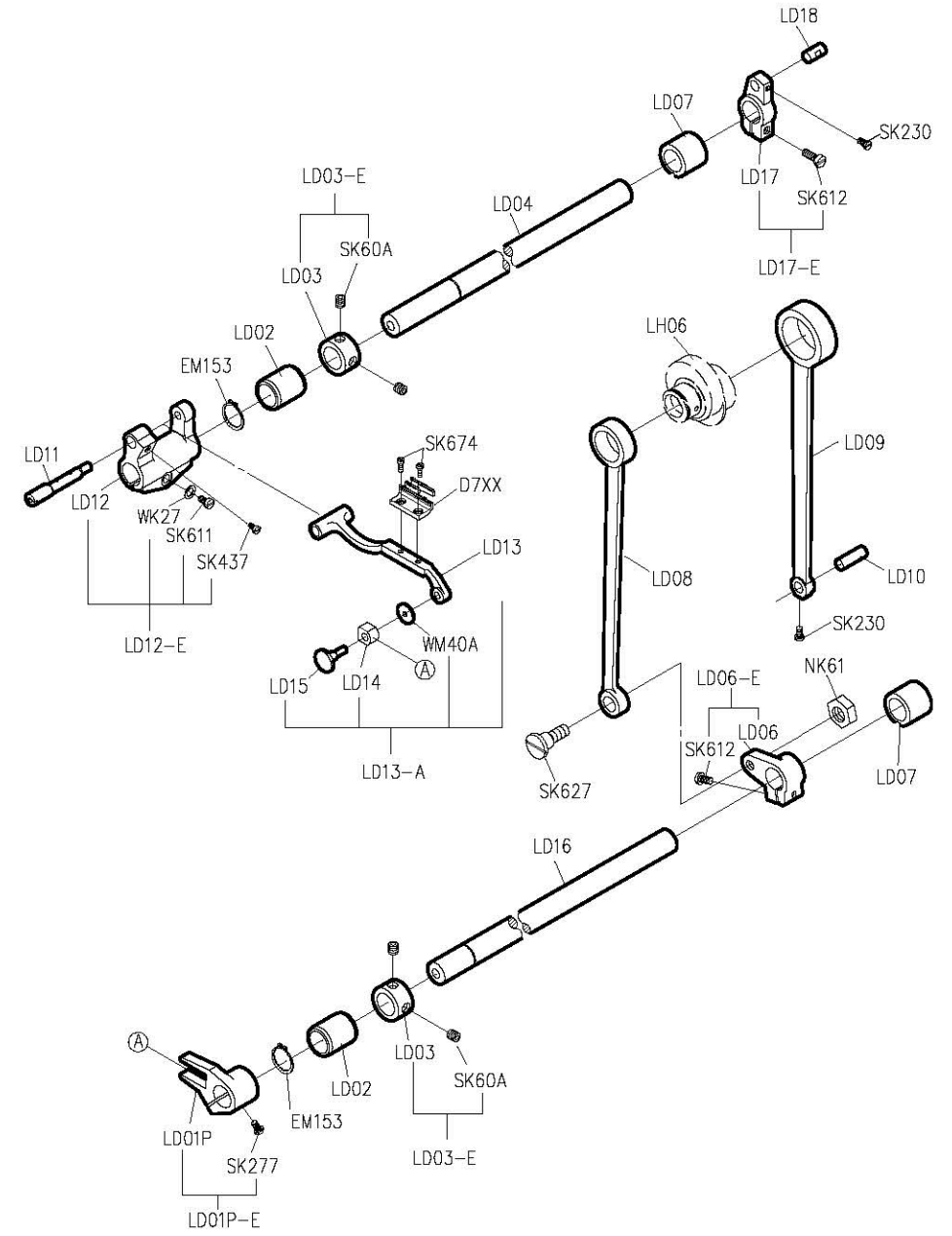
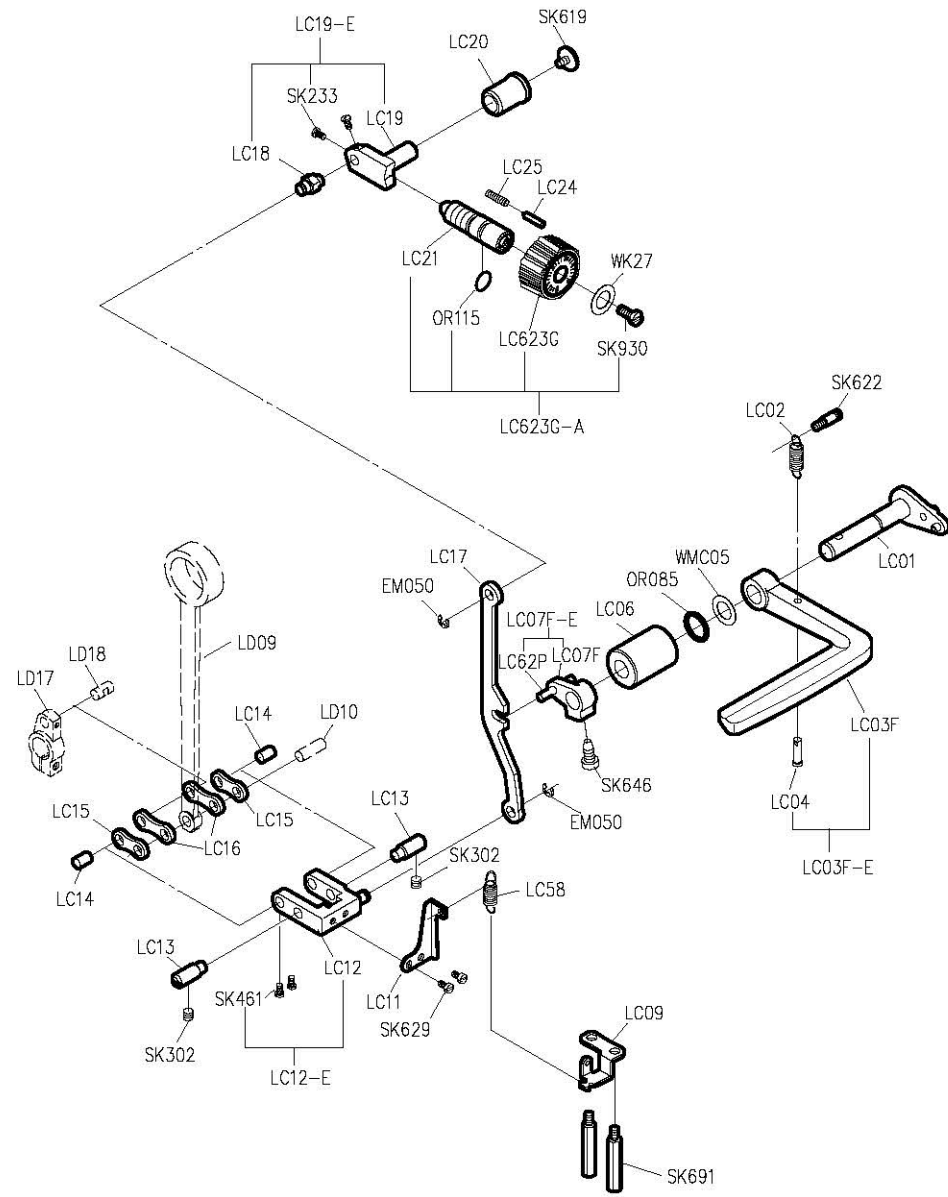

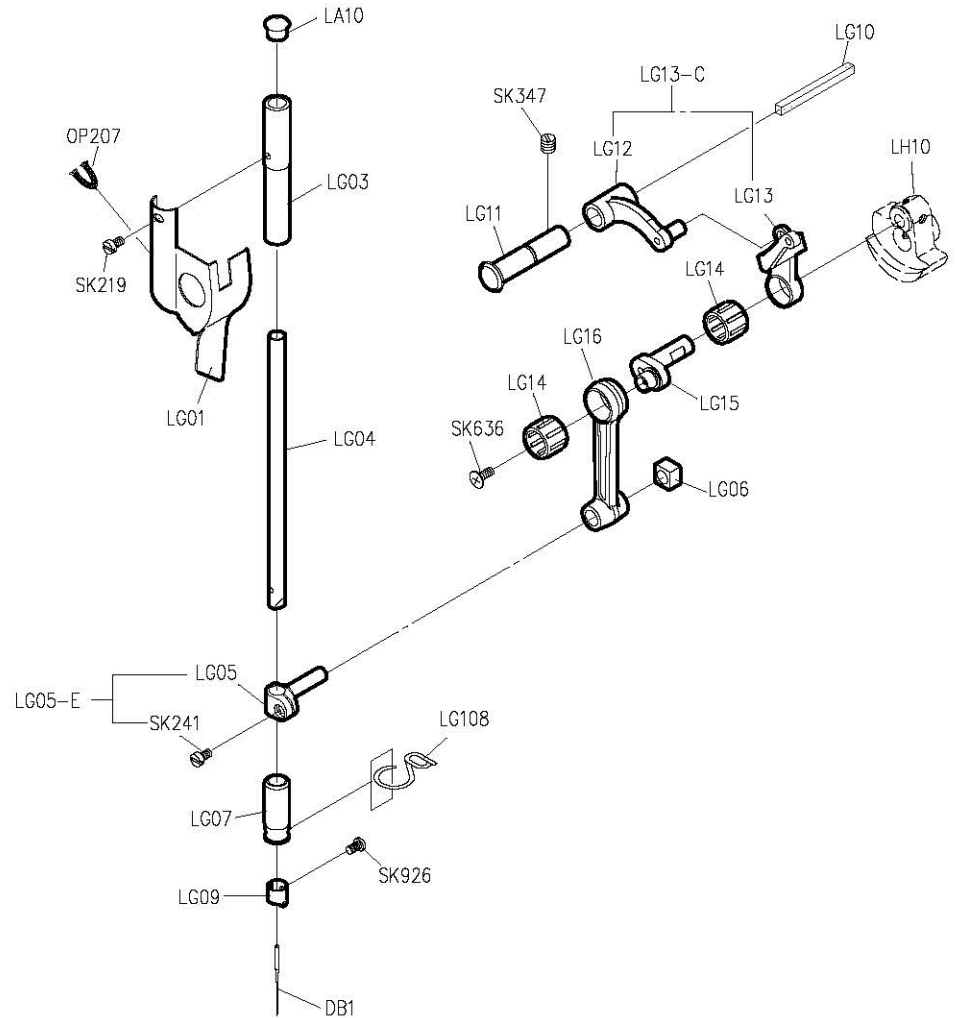
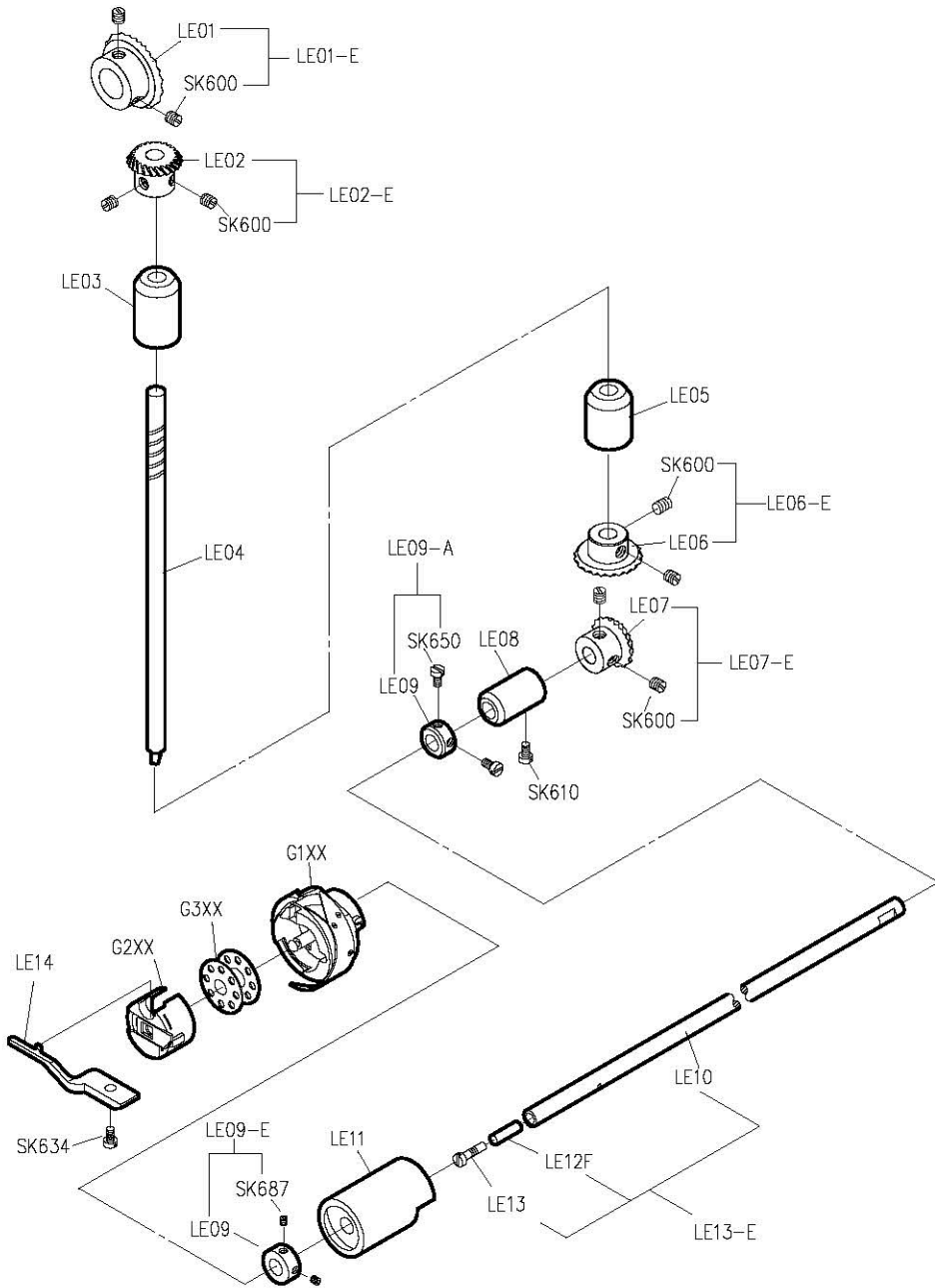

PARTS LIST FOR LH GROUP

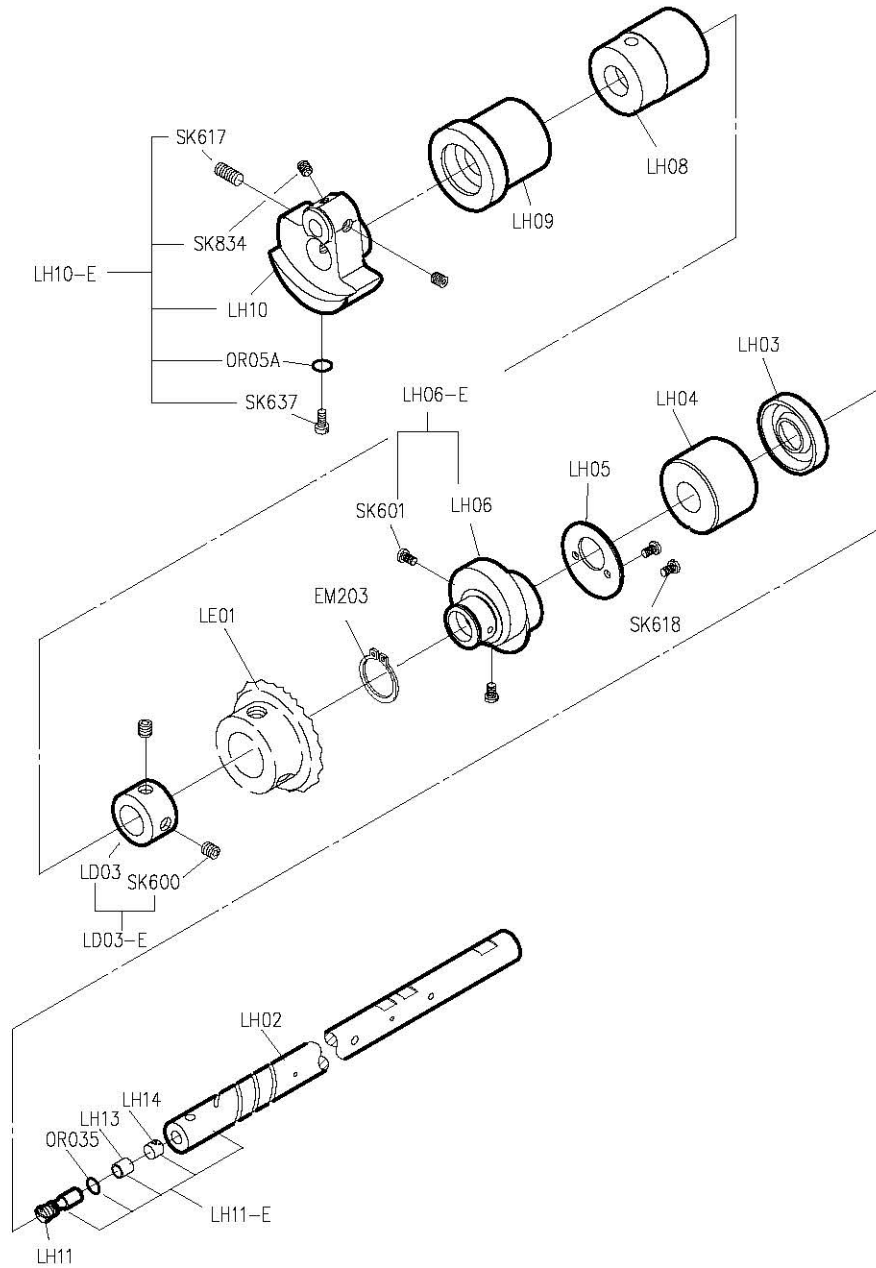

PARTS LIST FOR LH GROUP

H 廠牌馬達

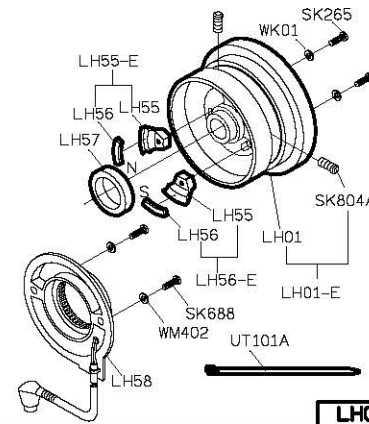

LH01-A

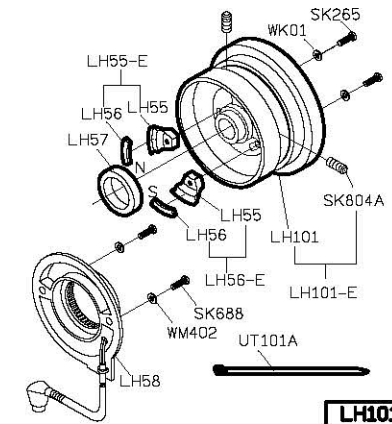

LH101-A

其他廠牌馬達

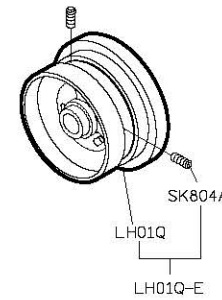

LH01Q-E

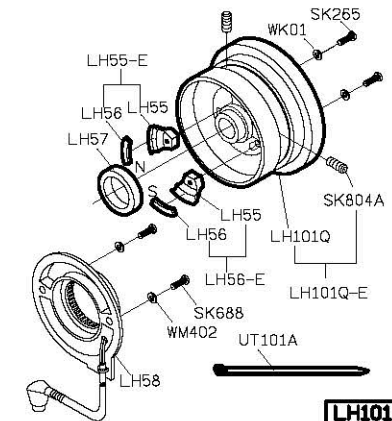

LH101Q-A

P 廠牌馬達

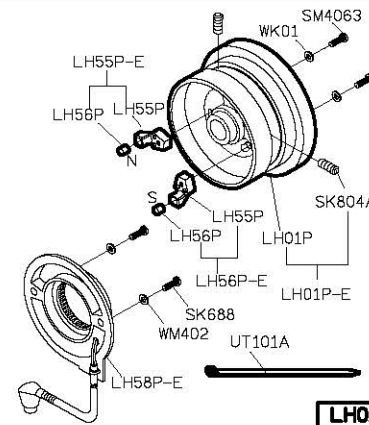

LH01P-A

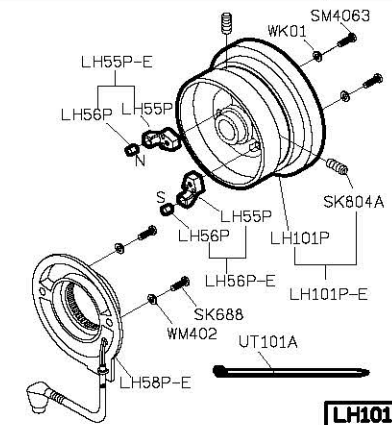

LH101P-A

PARTS LIST FOR LU GROUP

PARTS LIST FOR LU GROUP

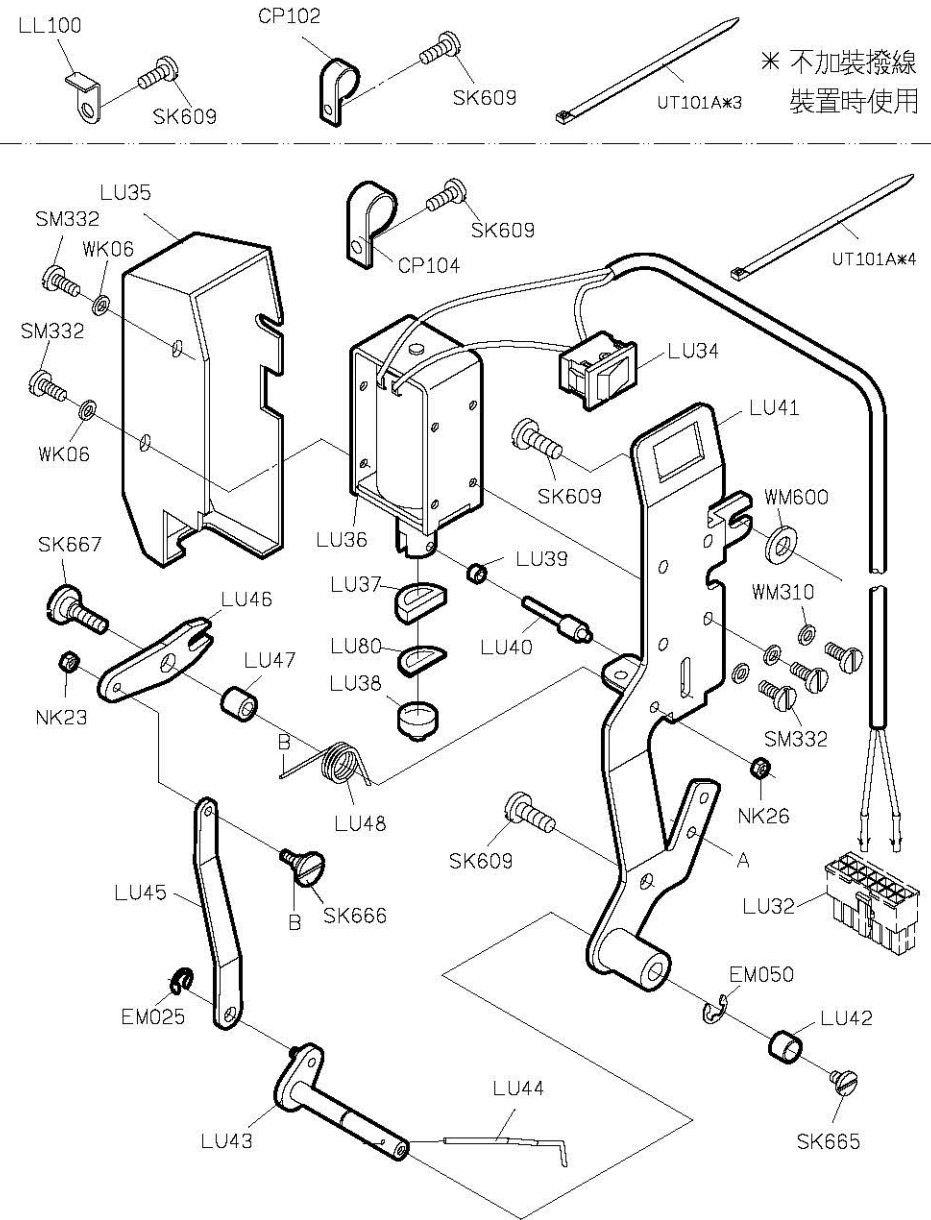
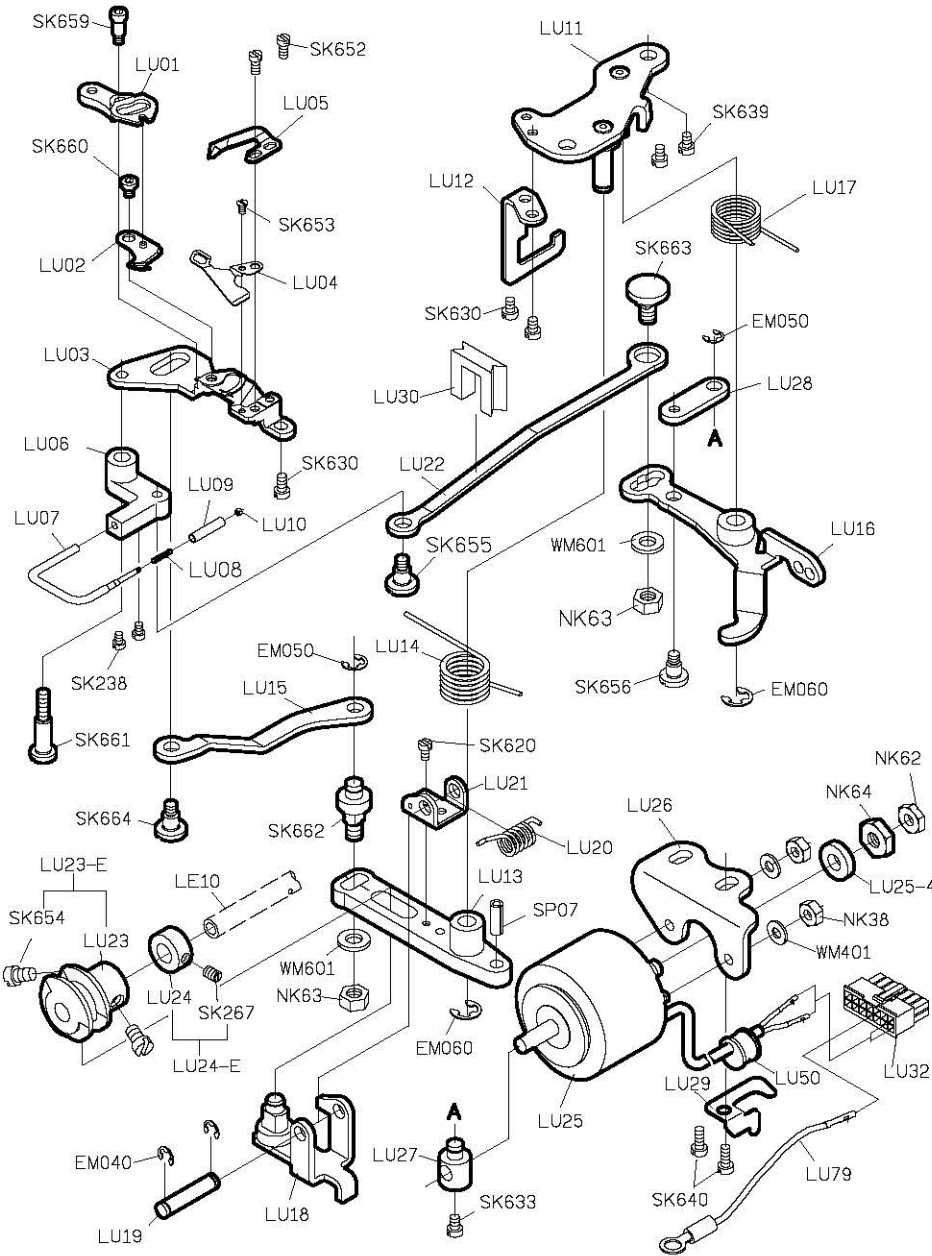

* 不加裝撥線
裝置時使用

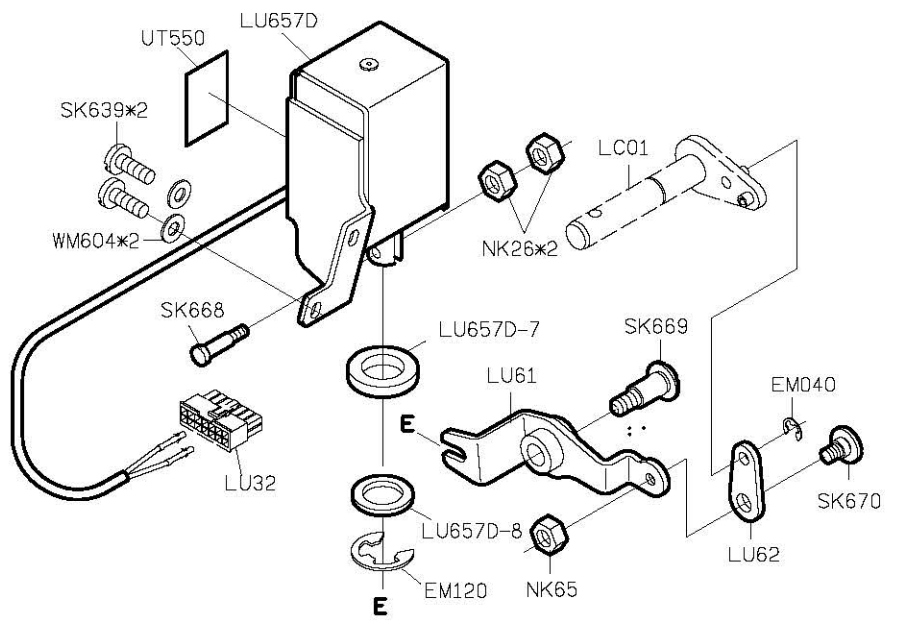
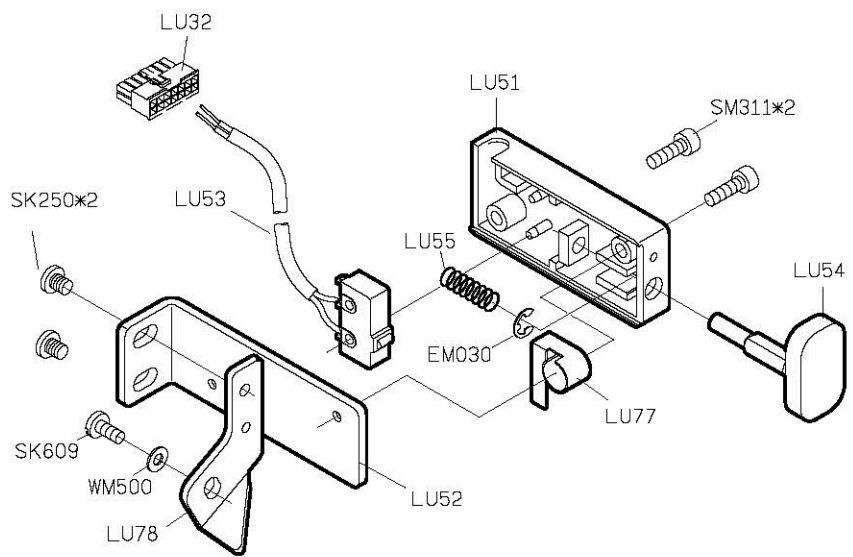

LU64D-A

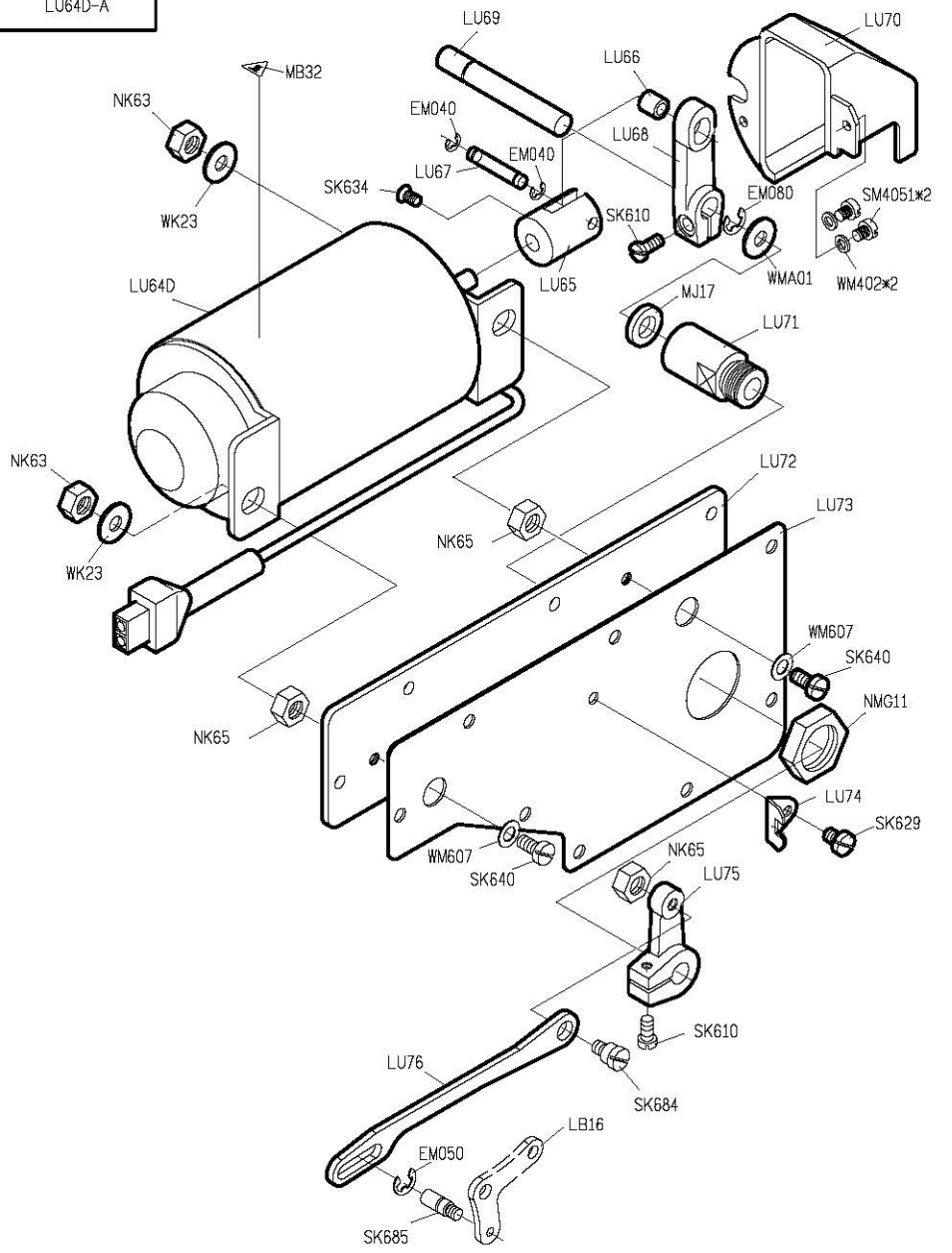

T666 (定位馬達)
T777 (伺服馬達)

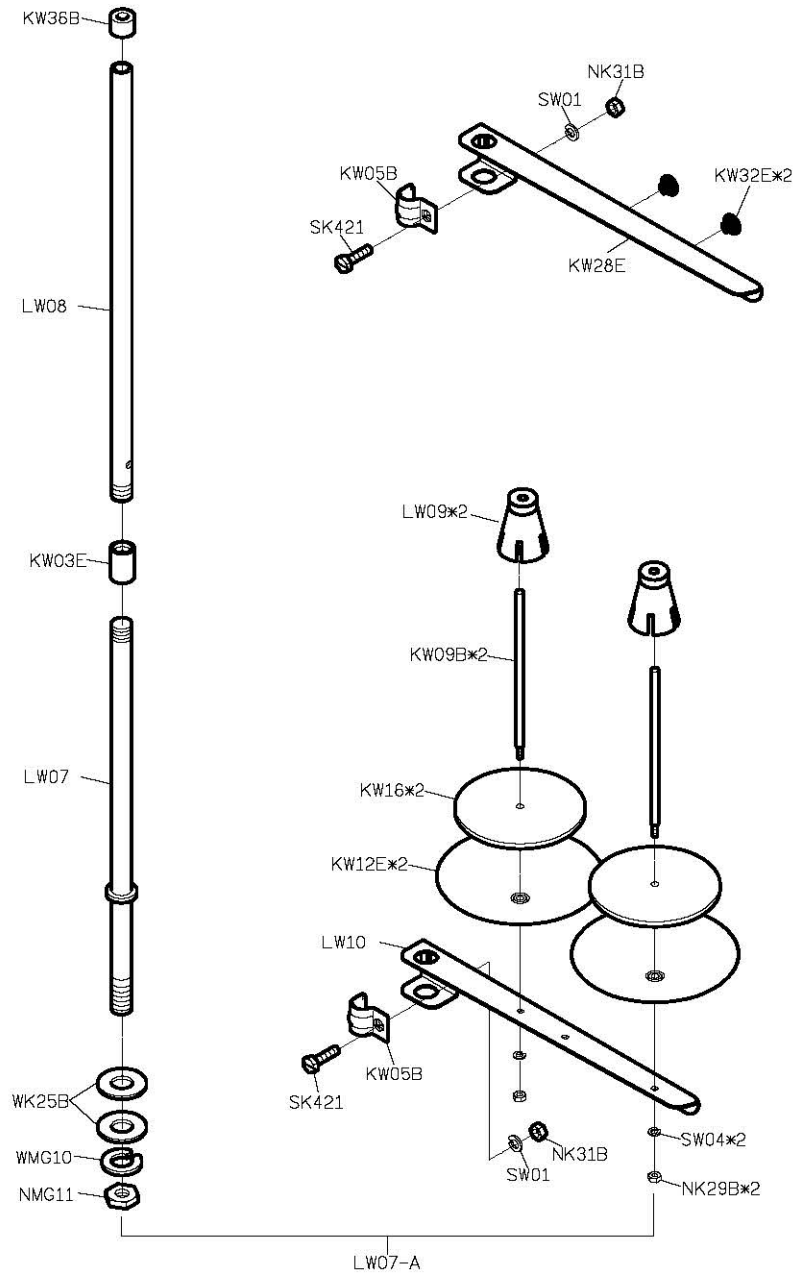
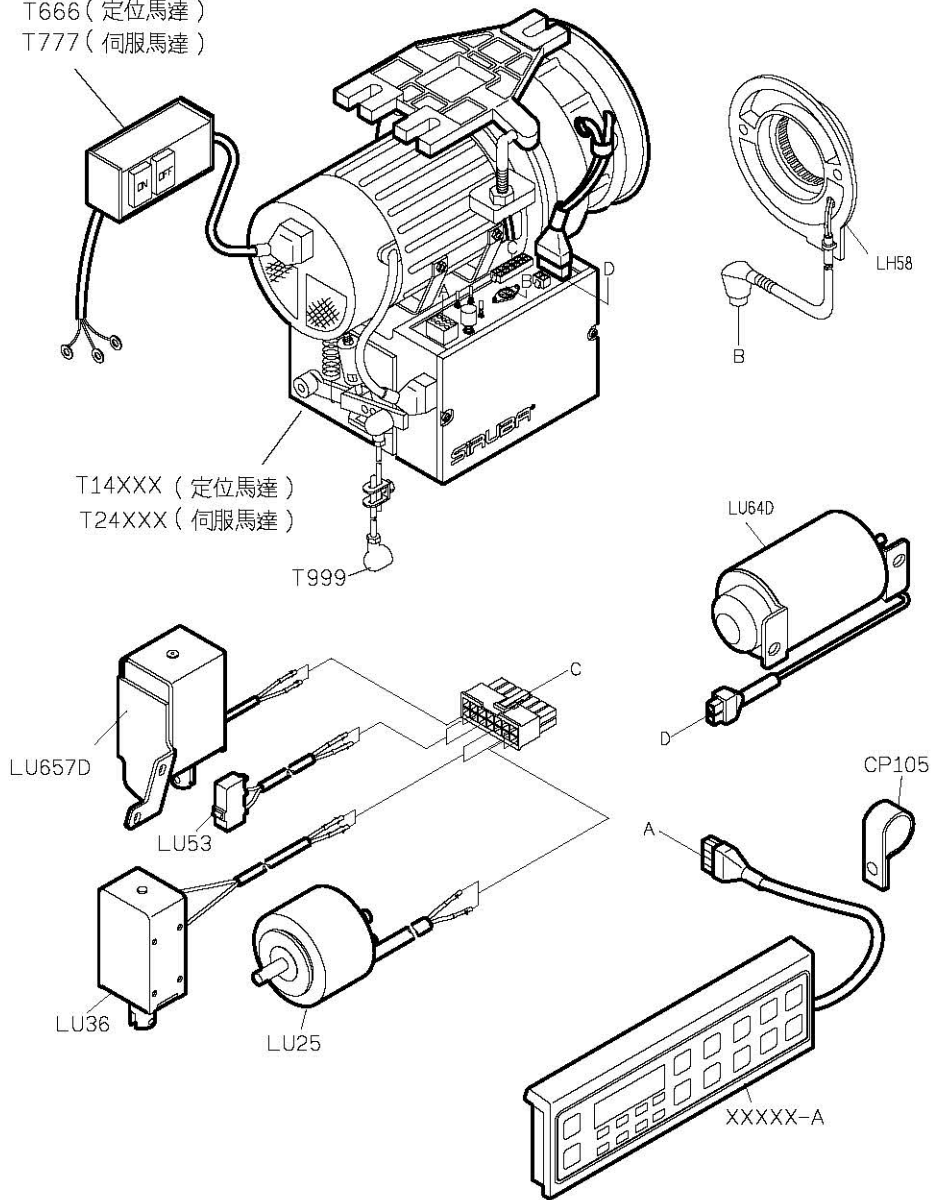

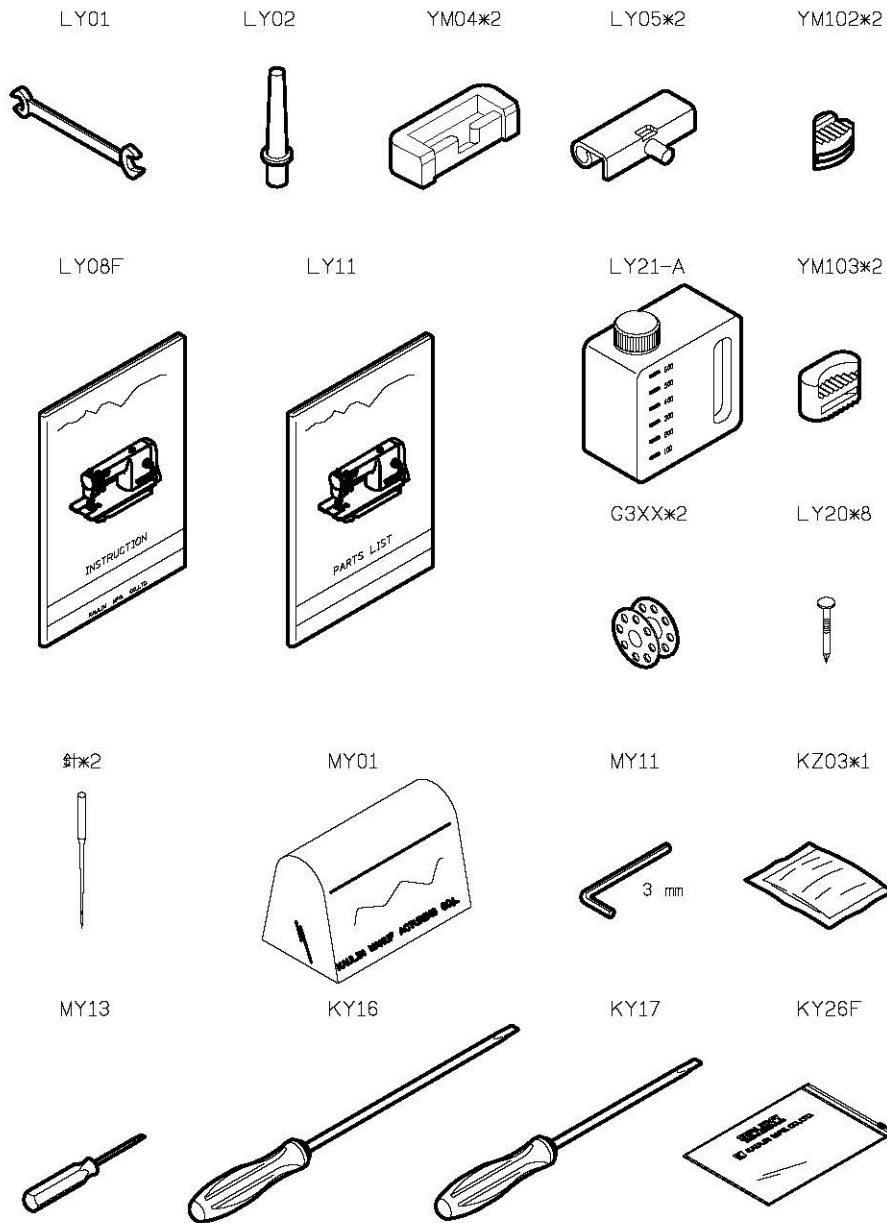

PARTS LIST For LY group

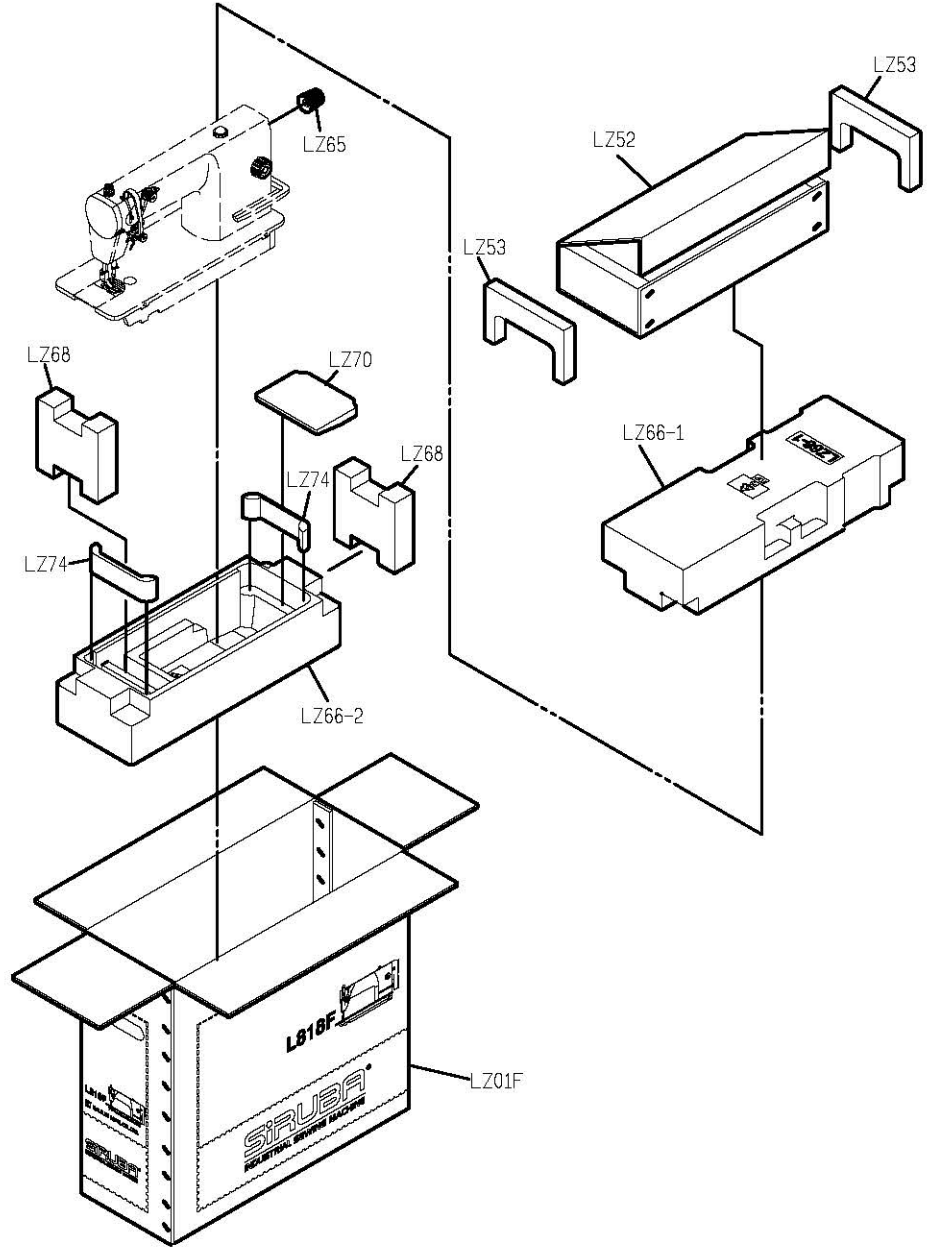

PARTS LIST FOR LZ GROUP

From the library of: Superior Sewing Machine & Supply LLC



L818F

WITH TRIMMER

高林股份有限公司 KAULIN MFG. CO., LTD.