













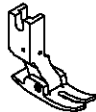





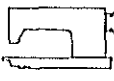

SIRUBA GAGE PARTS LIST	Series	Remark	Page	Date
	L818D	L818D-L1/M1/H1/HM1	1/1	2012/11/01

L818D-L1/M1/H1規格件表/CONVERSION CHART

								
MODEL	SUB-CLASS	NEEDLE PLATE	FEED DOG	PRESSER FOOT	HOOK ASM	BOBBIN CASE ASM	BOBBIN	NEEDLE
機 型	規 格	針 板	送 具	押 具	梭 頭	梭 殼	梭 子	針 號
L818D-L1	薄布料	E701	D701	P721	G111C	G201C	G303	DAX1#9
L818D-M1	薄中布 至 中厚布	E701	D701	P701	G111C		G301	DBX1#14
L818D-HM1								
L818D-M1A								
L818D-M1C								
L818D-HM1A								
L818D-H1		中厚布 至 厚布料	E711					
L818D-H1A								
L818D-H1C	E711D		D711D	P711D				

SIRUBA MODEL COMPARE LIST	Series	Remark	Page	Date
	L918/L917/L818D	-L1/M1/H1	1 / 2	2013/06/10

L918/L917/L818D型別件表

												
MODEL	SUB-CLASS	SPRING	SPRING	SPRING	THREAD GUIDE	THREAD GUIDE BAR	EJECTOR PIN	ADJUSTING KNOB	NEEDLE BAR	FIXED PIN	HOOK FIXER	
機 型	規 格	控線彈簧	挑線彈簧	壓 簧	導線片	導線杆	頂出銷	調整旋扭	針 棒	固定銷	旋梭定位板	
L1	薄布料	LA231	LA227	LB204	A	LB06H	—	LB212	LC23G	LG04	LC13	LE14D
					B	SK241						
M1	薄布料 ~ 中厚布	LA31	LA27	LB04	A	LB06H	—	LB12	LC623G	LG04	LC13	LE14D
					B	SK241						
H1	中厚布 ~ 厚布料	LA131		LB104	—	A	LB100	LC600G	LG104	LC613	LE614D	
						B	LB106					
						C	NK23					
						D	WK09					

SIRUBA
MODEL COMPARE LIST

Series

L918/L917/L818D

Remark

-L1/M1/H1







Page

2/2

Date

2013/01/01

L918/L917/L818D型別件表

							
MODEL	SUB-CLASS	THRAD TAKE UP LEVER	CRANK SHAFT	BUSING	THREAD GUIDE		
機 型	規 格	天 秤	曲 軸	襯 套	導 線 環 片		
L1	薄布料	LG13	LG215	LG07	LG09		
M1	薄布料 ~ 中厚布		LG15				
H1	中厚布 ~ 厚布料	LG113	LG615	LG107	LG109		

SIRUBA PARTS LIST	Series	Parts Group	Subclass / Remark	Page
	L818D-M1/H1	LA	#:Use for H1 □:Use for L1	1/1
				Date
				2012/12/30

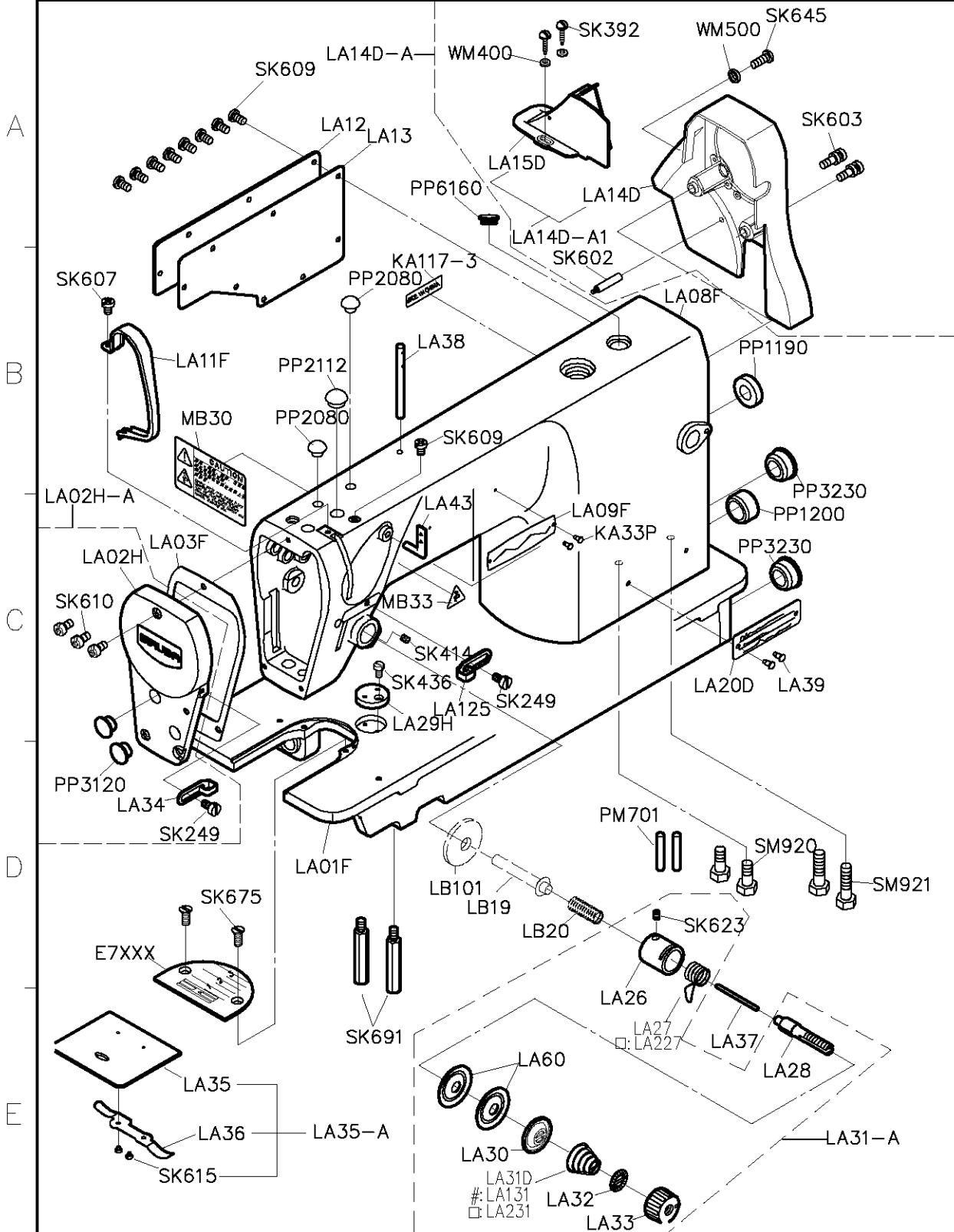

SIRUBA PARTS LIST	Series	Parts Group	Subclass / Remark	Page
	L818D-M1/H1	LB	#:Use for H1 □:Use for L1	1/1
				Date
				2012/12/30

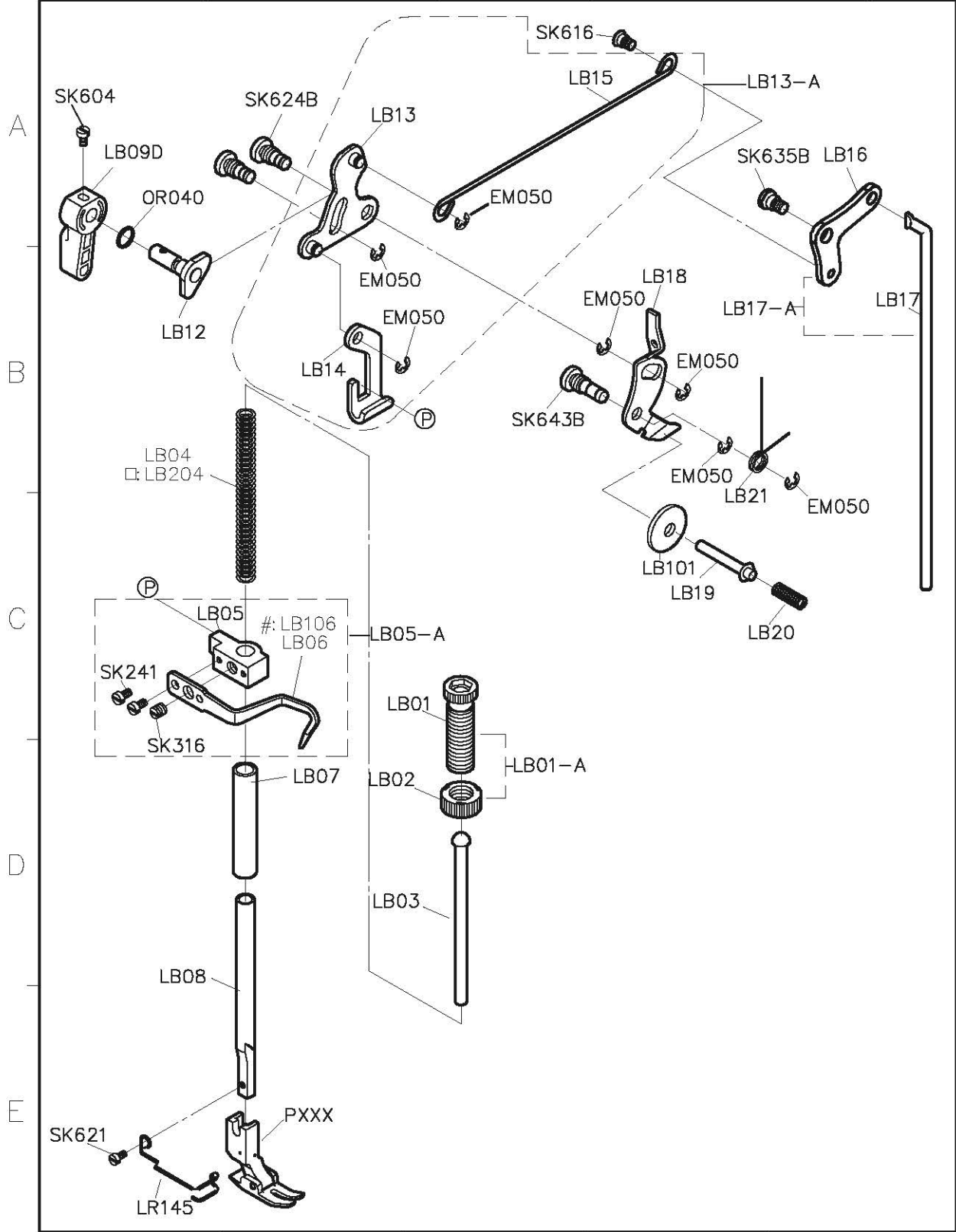

SIRUBA PARTS LIST	Series	Parts Group	Subclass / Remark	Page
	L818D-M1/H1	LC	#:Use for H1 □:Use for L1	1/1
				Date
				2012/12/30

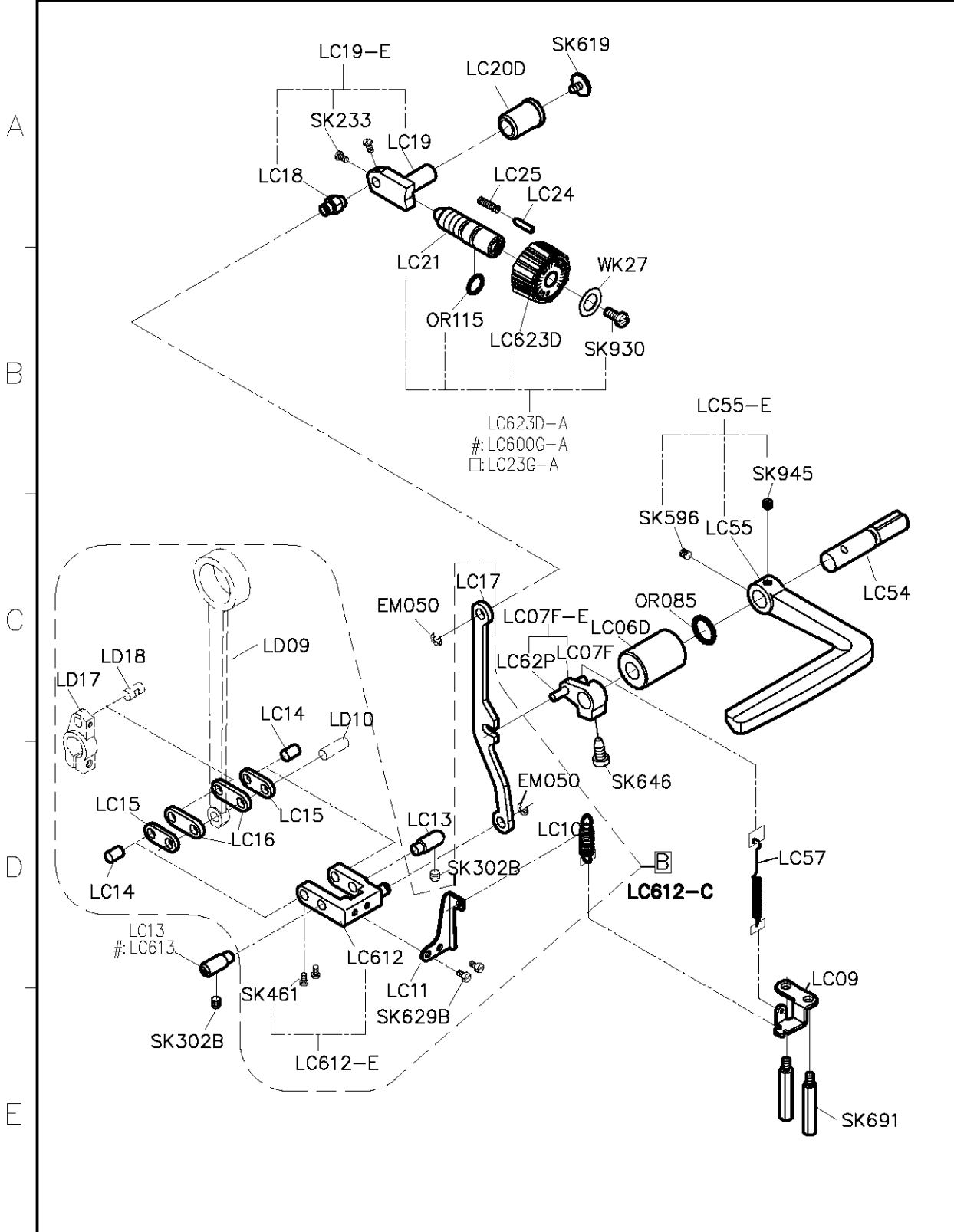

SIRUBA PARTS LIST	Series	Parts Group	Subclass / Remark	Page
	L818D-M1/H1	LD		1/1
				Date
				2012/12/30

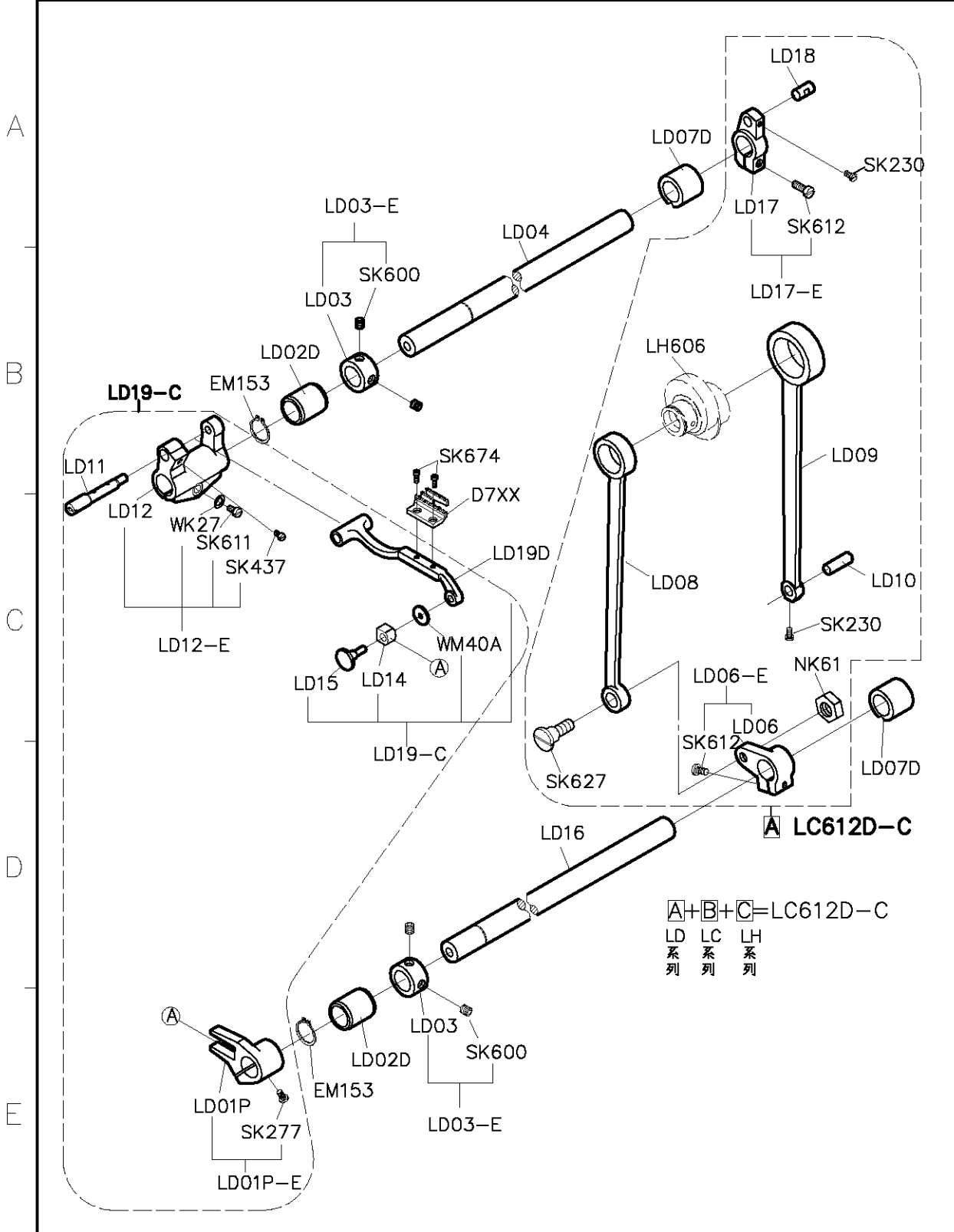

SIRUBA PARTS LIST	Series	Parts Group	Subclass / Remark	Page
	L818D-M1/H1	LE	#:Use for H1	1/1
				Date
				2012/12/30

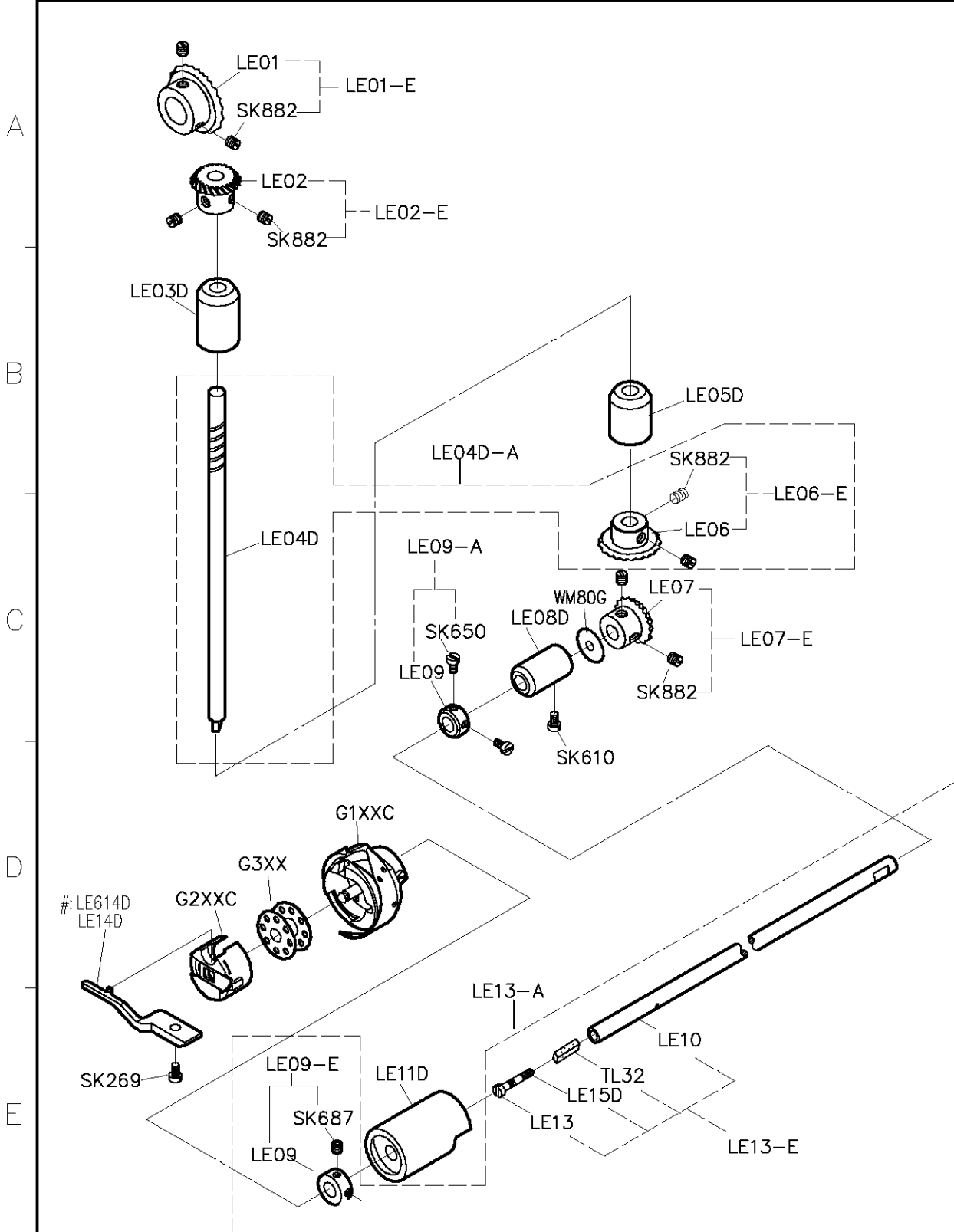

SIRUBA PARTS LIST	Series	Parts Group	Subclass / Remark	Page
	L818D-M1/H1	LG	#:Use for H1 □:Use for L1	1/1
				Date
				2012/12/30

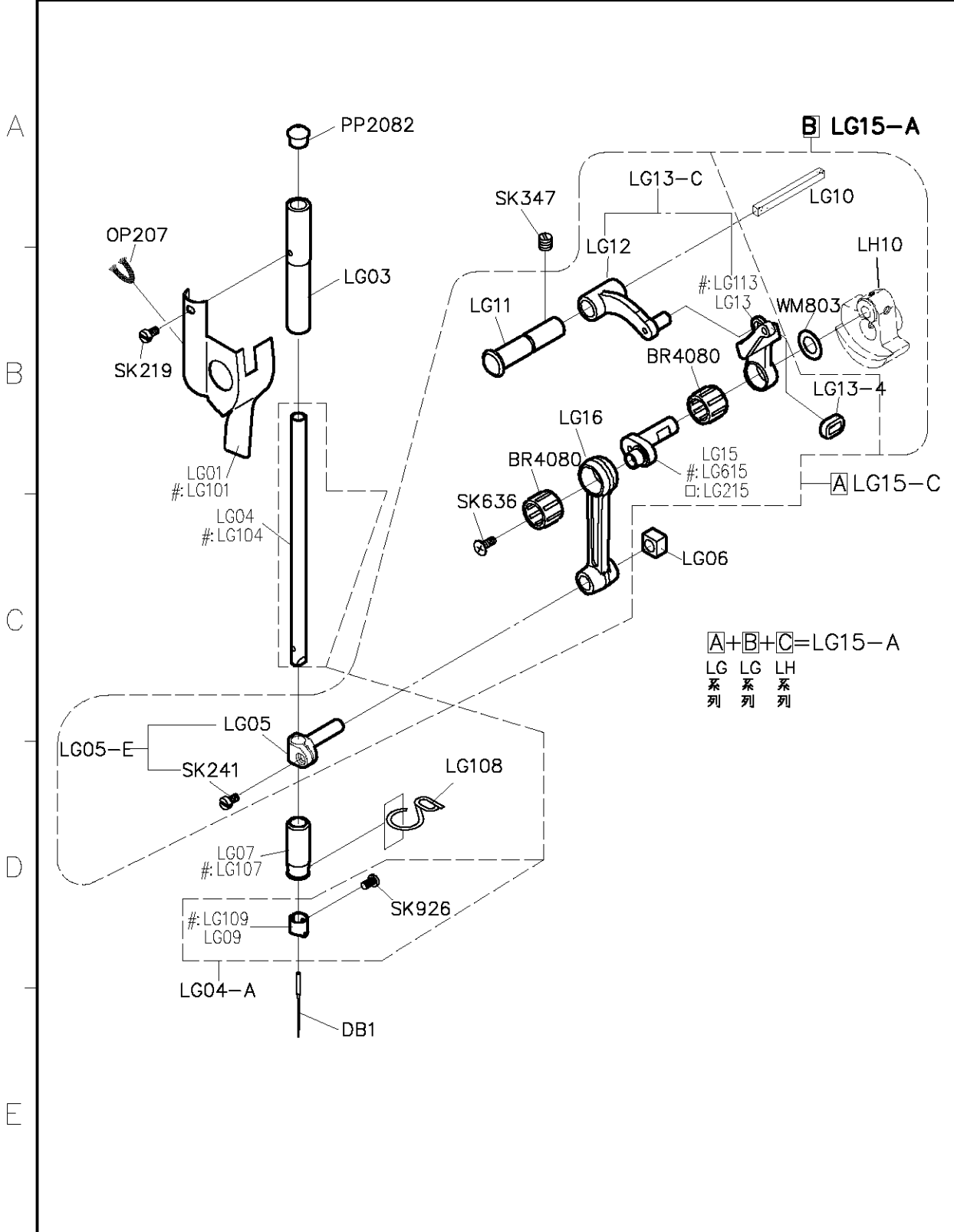

SIRUBA PARTS LIST	Series	Parts Group	Subclass / Remark	Page
	L818D-M1/H1	LH	#:Use for H1	1/1
				Date
				2012/12/30

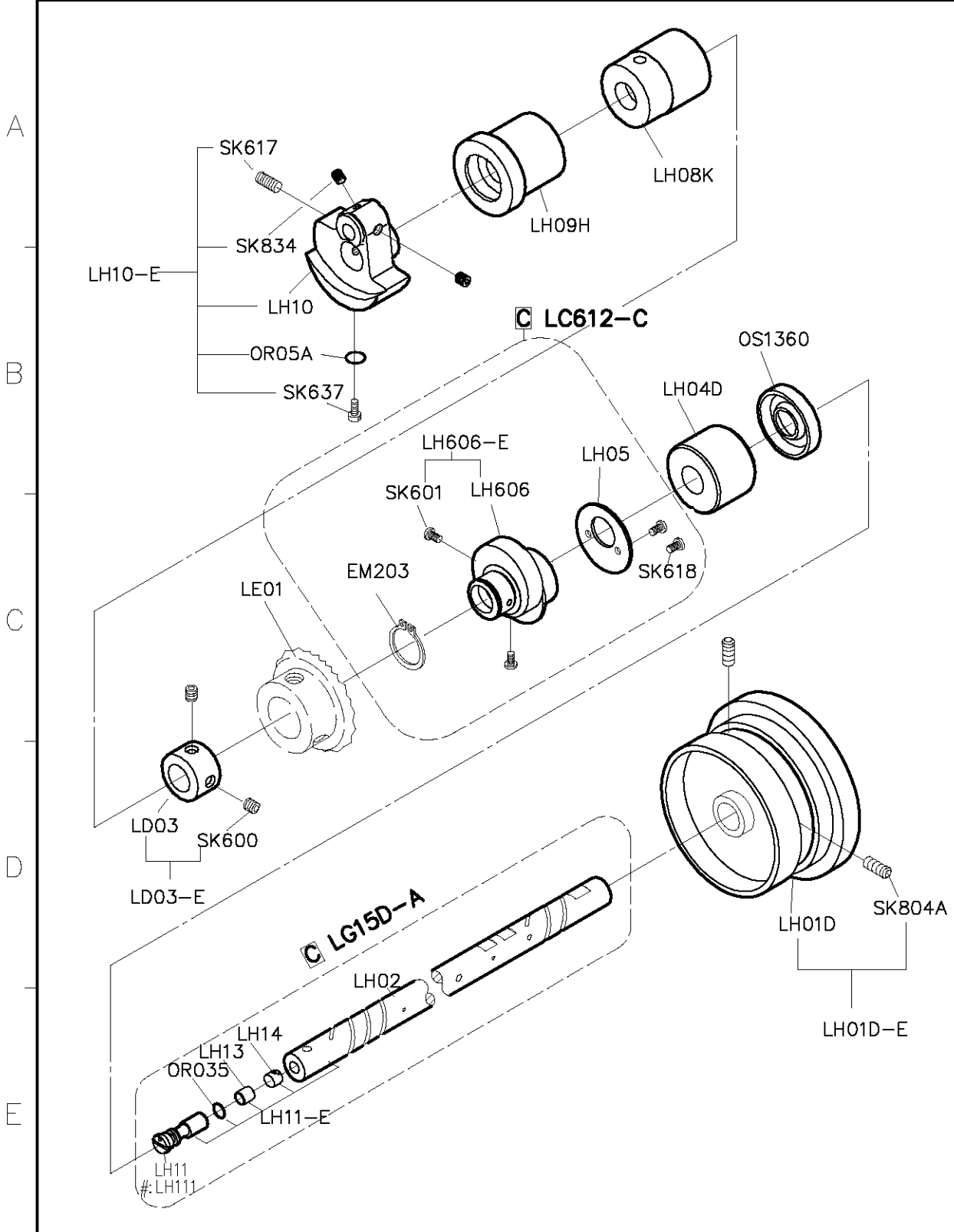

SIRUBA PARTS LIST	Series	Parts Group	Subclass / Remark	Page
	L818D-M1/H1	LL		1/1
				Date
				2012/12/30

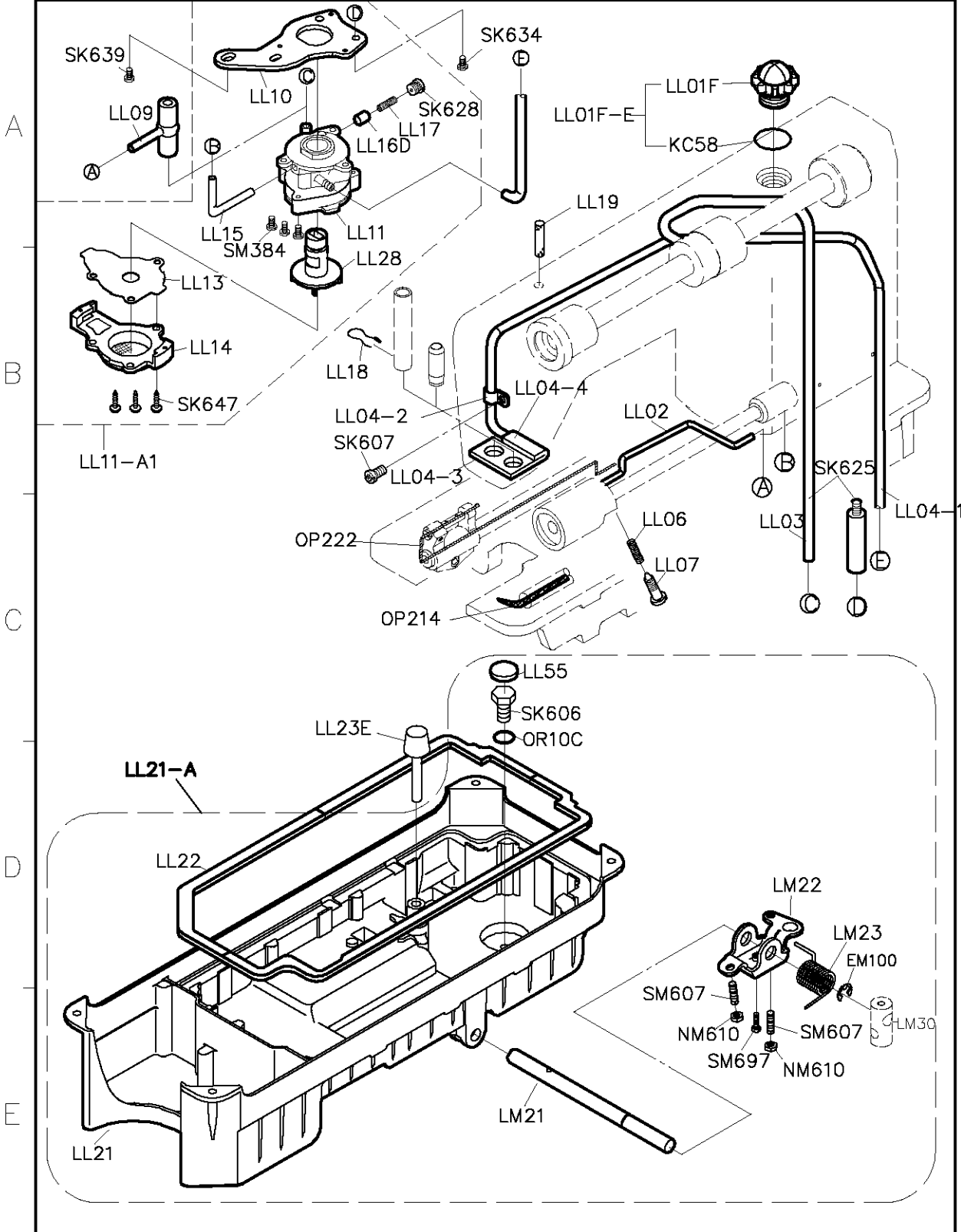

SIRUBA PARTS LIST	Series	Parts Group	Subclass / Remark	Page
	L818D-M1/H1	LM		1/1
				Date
				2012/12/30

LM01H-A

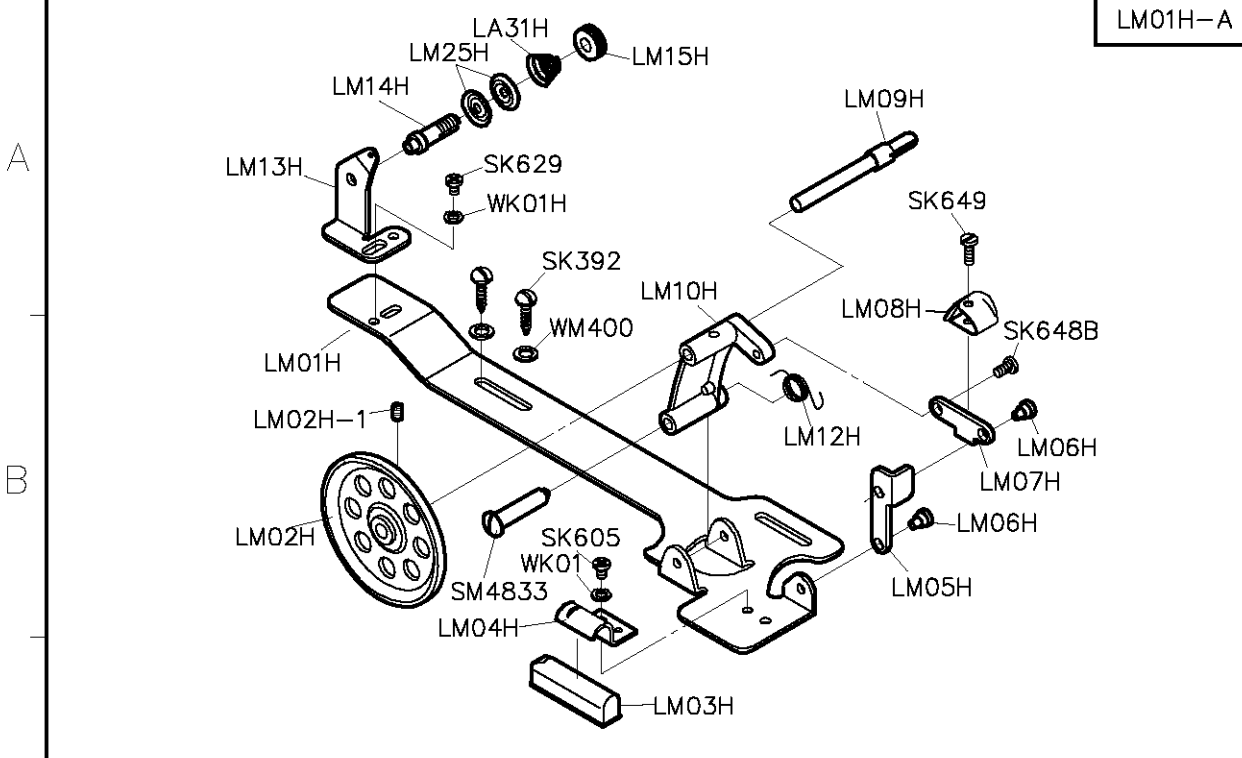

LM20-A



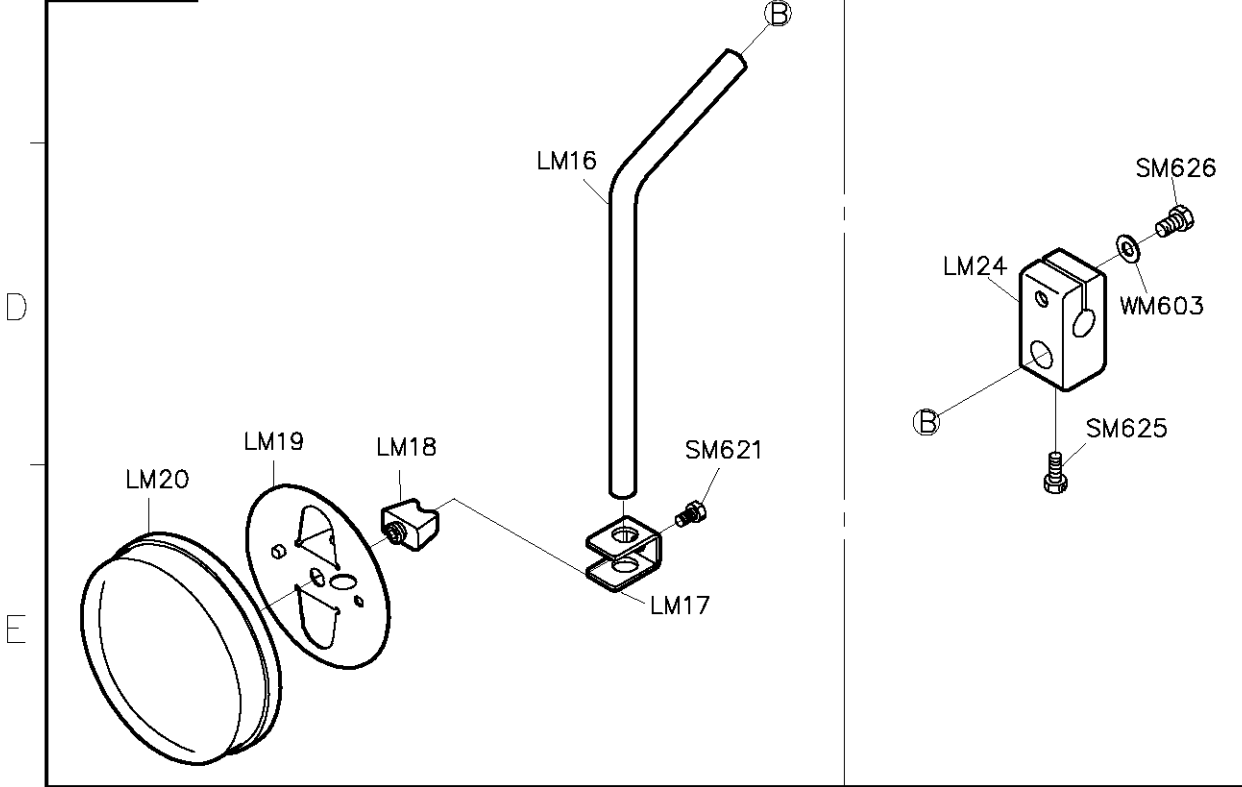



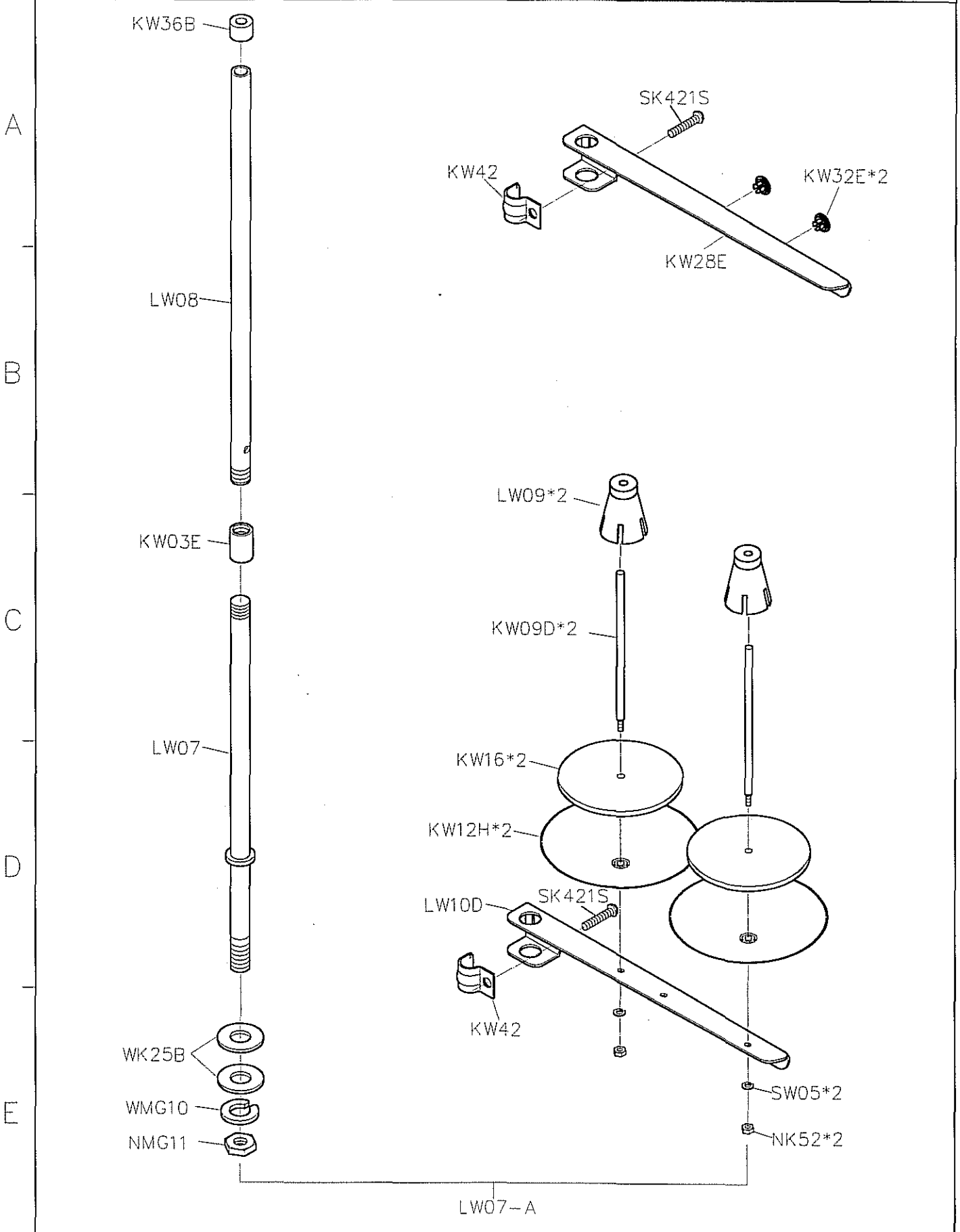

LM24-E

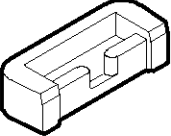
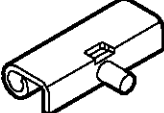

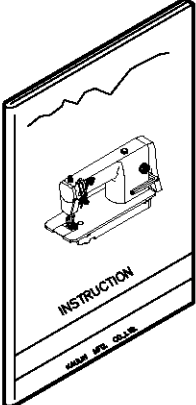
SIRUBA PARTS LIST	Series	Parts Group	Subclass / Remark	Page
	L818D-M1/H1	LW		1/1
				Date
				2012/04/10



SIRUBA PARTS LIST	Series	Parts Group	Subclass / Remark	Page
	L818D-M1/H1	LY		1/1
				Date
				2012/12/30

	LY02D	YM04*2	LY05*2	YM102*2
A				
B	LY36D		LY37-A	G3XX
C				
D	針*2	KY201	YM103*2	KZ03*1
E				
	1	2	3	4

SIRUBA PARTS LIST	Series	Parts Group	Subclass / Remark	Page
	L818D-M1/H1	LZ		1/1
				Date
				2012/12/30

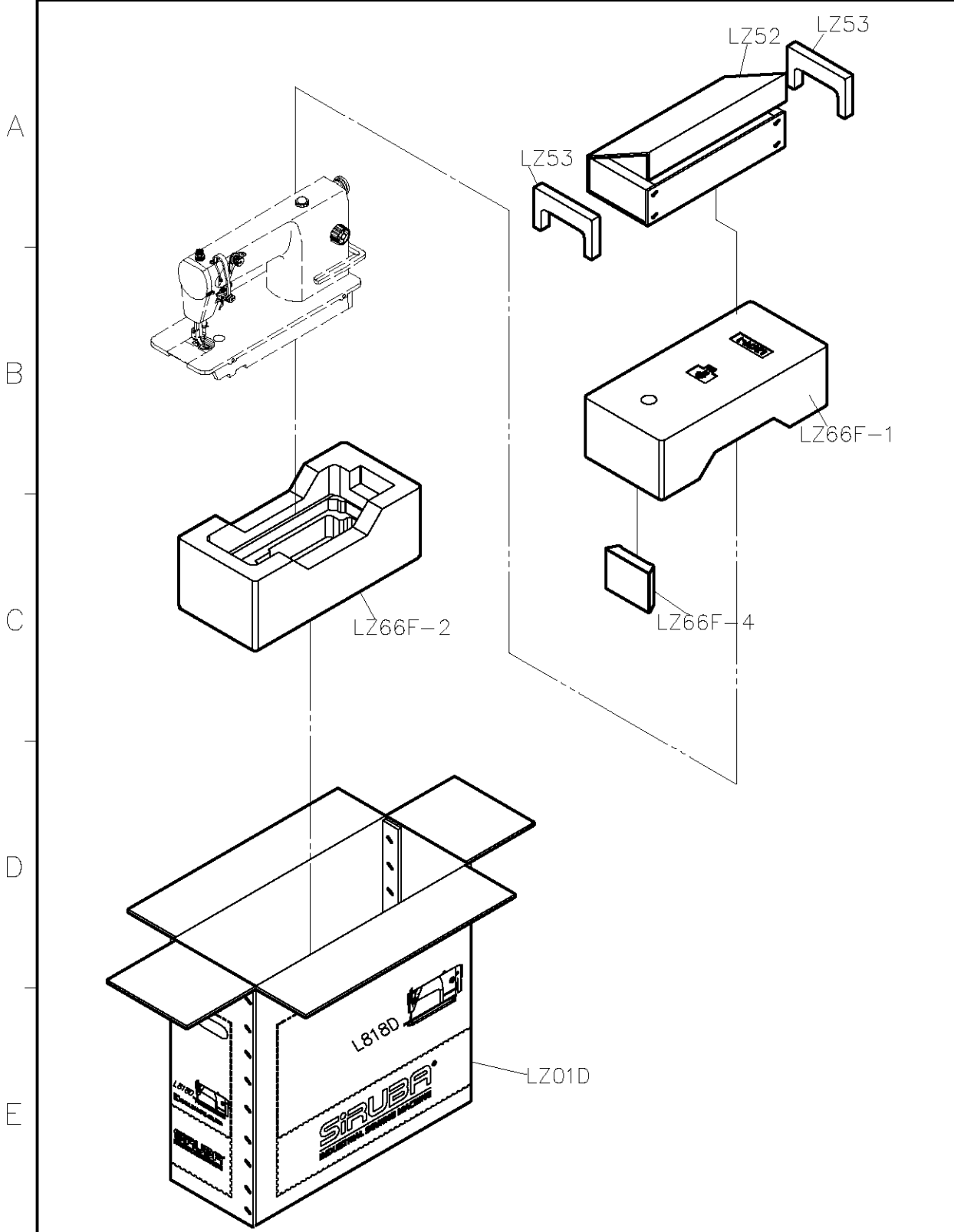

SIRUBA TABLE CUT - OUT	Series	Item Code	Subclass / Remark	Mounting
	L818D/L917 L918/L918U L819/L819U	L918-T1		Fully-submerged
				Date
				2013/01/01

