

SIRUBA®

銀箭牌工業用縫紉機

INDUSTRIAL SEWING MACHINE





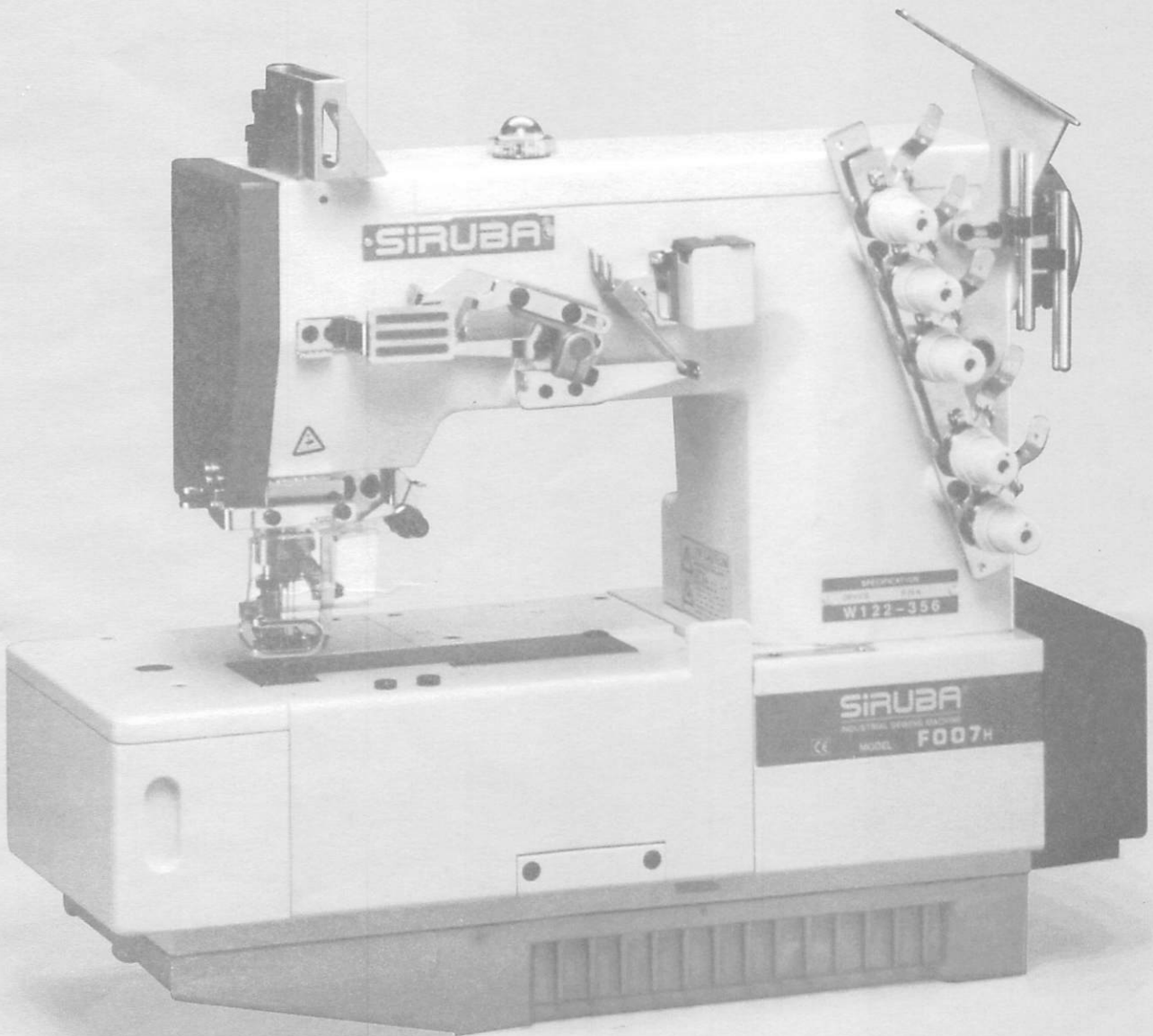

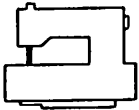

F007H

零件圖 PARTS LIST





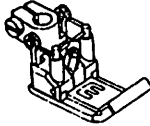
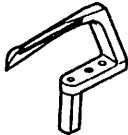





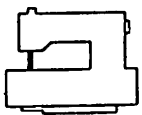
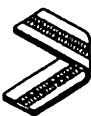

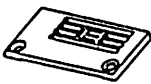

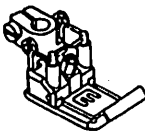
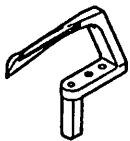

CE

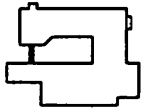
 高林股份有限公司
KAULIN MFG. CO., LTD.



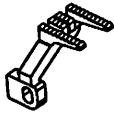
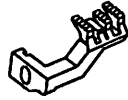
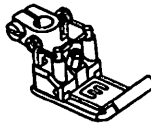



									
MODEL	SUB - CLASS	NEEDLE CLAMP	NEEDLE PLATE	MAIN FEED DOG	DIFF. FEED DOG	PRESSER FOOT	LOOPER	SPREADER	NEEDLE
機 型	規 格	針 座	針 板	主 送 具	差 送 具	押 具	勾 針	上 叉	針 號
F007H - W122	240	M5240	E1524	D1206	H1258	P0024	ME28	MH41E	UY128GAS #11
	248	M5248	E1525	D1206	H1258	P0025			
	356	M5356	E1826	D1207	H1259	P0216			
	364	M5364	E1827	D1207	H1259	P0217			
F007H - W122 / UTG (UTJ)	240	M5240	E1524	D1206	H1258	P0024	ME28	MH41E	UY128GAS #11
	248	M5248	E1525	D1206	H1258	P0025			
	356	M5356	E1826	D1207	H1259	P0216			
	364	M5364	E1827	D1207	H1259	P0217			
F007H - U122	240	M5240	E1524	D1206	H1258	P0314	ME28	-	UY128GAS #11
	248	M5248	E1525	D1206	H1258	P0315			
	356	M5356	E1826	D1207	H1259	P0416			
	364	M5364	E1827	D1207	H1259	P0417			
F007H - U122 / UTH (UTK)	240	M5240	E1524	D1206	H1258	P0314	ME28	-	UY128GAS #11
	248	M5248	E1525	D1206	H1258	P0315			
	356	M5356	E1826	D1207	H1259	P0416			
	364	M5364	E1827	D1207	H1259	P0417			
F007H - U122 / FP	232	M5232	E1623	D1206	H1257	P4011	ME28P	-	UY128GAS #14
F007H - W123	240	M5240	E1534	D1206	H1258	P0024	ME28	MH41E	UY128GAS #11
	248	M5248	E1535	D1206	H1258	P0025			
	356	M5356	E1836	D1207	H1259	P0216			
	364	M5364	E1837	D1207	H1259	P0217			



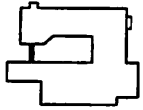

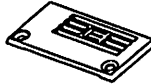

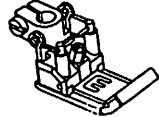
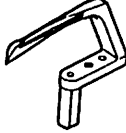

規格件表 • CONVERSION CHART

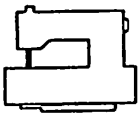
									
MODEL	SUB - CLASS	NEEDLE CLAMP	NEEDLE PLATE	MAIN FEED DOG	DIFF. FEED DOG	PRESSER FOOT	LOOPER	SPREADER	NEEDLE
機 型	規 格	針 座	針 板	主 送 具	差 送 具	押 具	勾 針	上 叉	針 號
F007H - W123 / UTG (UTJ)	240	M5240	E1534	D1206	H1258	P0024	ME28	MH41E	UY128GAS #11
	248	M5248	E1535	D1206	H1258	P0025			
	356	M5356	E1836	D1207	H1259	P0216			
	364	M5364	E1837	D1207	H1259	P0217			
F007H - W162	356	M5356	E1846	D1207	H1259	P0226	ME28A	MH41E	UY128GAS #14 -16
	364	M5364	E1847	D1207	H1259	P0227			
F007H - U162	356	M5356	E1846	D1207	H1259	P0226	ME28A	-	UY128GAS #14 -16
	364	M5364	E1847	D1207	H1259	P0227			
F007H - W162 / UTG (UTJ)	356	M5356	E1846	D1207	H1259	P0226	ME28A	MH41E	UY128GAS #14 -16
	364	M5364	E1847	D1207	H1259	P0227			
F007H - U162 / UTH (UTK)	356	M5356	E1846	D1207	H1259	P0226	ME28A	-	UY128GAS #14 -16
	364	M5364	E1847	D1207	H1259	P0227			
F007H - W222 / FQ	240	M5240	E3024	D1215	H1261	P1814	ME28	MH41E	UY128GAS #11
	248	M5248	E3025	D1215	H1261	P1815			
	356	M5356	E3326	D1216	H1262	P2116			
	364	M5364	E3327	D1216	H1262	P2117			
F007H - W222 / FQ / FEC (FAC)	240	M5240	E3024	D1215	H1261	P1814	ME28	MH41E	UY128GAS #11
	248	M5248	E3025	D1215	H1261	P1815			
	356	M5356	E3326	D1216	H1262	P2116			
	364	M5364	E3327	D1216	H1262	P2117			
F007H - U222 / FQ	240	M5240	E3024	D1215	H1261	P2314	ME28	-	UY128GAS #11
	248	M5248	E3025	D1215	H1261	P2315			

									
MODEL	SUB - CLASS	NEEDLE CLAMP	NEEDLE PLATE	MAIN FEED DOG	DIFF. FEED DOG	PRESSER FOOT	SPREADER	LOOPER	NEEDLE
機 型	規 格	針 座	針 板	主 送 具	差 送 具	押 具	上 叉	勾 針	針 號
C007H - W162	240	M5240	E3544	D4206	H4258	P0234	MH41E	MT01A	UY128GAS #14 - 16
	248	M5248	E3545	D4206	H4258	P0235			
	356	M5356	E3846	D4206	H4258	P0226			
	364	M5364	E3847	D4207	H4259	P0227			
C007H - U162	240	M5240	E3544	D4206	H4258	P0234	-	MT01	UY128GAS #11
	248	M5248	E3545	D4206	H4258	P0235			
	356	M5356	E3846	D4206	H4258	P0226			
	364	M5356	E3847	D4207	H4259	P0227			
C007H - W162 / UTP (UTR)	240	M5240	E3544	D4206	H4258	P0234	MH41E	MT01A	UY128GAS #14 - 16
	248	M5248	E3545	D4206	H4258	P0235			
	356	M5356	E3846	D4206	H4258	P0226			
	364	M5364	E3847	D4207	H4259	P0227			
C007H - U162 / UTQ (UTS)	240	M5240	E3544	D4206	H4258	P0234	-	MT01A	UY128GAS #14 - 16
	248	M5248	E3545	D4206	H4258	P0235			
	356	M5356	E3846	D4206	H4258	P0226			
	364	M5356	E3847	D4207	H4259	P0227			
C007H - W222 / CQ	240	M5240	E4124P	D3216	H3362	P1814	MH41E	MT01	UY128GAS #11
	248	M5248	E4125P	D3216	H3362	P1815			
	356	M5356	E4426P	D3216	H3362	P2116			
	364	M5364	E4427P	D3217	H3363	P2117			
C007H - U222 / CQ	240	M5240	E4124P	E3216	H3362	P2314	-	MT01	UY128GAS #11
	248	M5248	E4125P	D3216	H3362	P2315			
	356	M5356	E4426P	D3216	H3362	P2616			

規格件表 • CONVERSION CHART

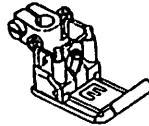
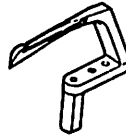
									
MODEL	SUB - CLASS	NEEDLE CLAMP	NEEDLE PLATE	MAIN FEED DOG	DIFF. FEED DOG	PRESSER FOOT	LOOPER	SPREADER	NEEDLE
機 型	規 格	針 座	針 板	主 送 具	差 送 具	押 具	勾 針	上 叉	針 號
F007H - U322 / FDC	356	M5356	E4826	D1207	H1359	P1606	ME28	-	UY128GAS #11
	364	M5364	E4827	D1207	H1359	P1607			
F007H - U322 / UTH (UTK)/FDC	356	M5356	E4826	D1207	H1359	P1606	ME28	-	UY128GAS #11
	364	M5364	E4827	D1207	H1359	P1607			
F007H - W322 / FDE	356	M5356	E4836M	D1207	H1459	P2406	ME28	MH41E	UY128GAS #11
	364	M5364	E4837M	D1207	H1459	P2407			
F007H - W322 / UTG (UTJ)/FDE	356	M5356	E4836M	D1207	H1459	P2406	ME28	MH41E	UY128GAS #11
	364	M5364	E4837M	D1207	H1459	P2407			
F007H - U322 / FDE	356	M5356	E4836M	D1207	H1459	P2606	ME28	-	UY128GAS #11
	364	M5364	E4837M	D1207	H1459	P2607			
F007H - U322 / UTH (UTK)/FDE	356	M5356	E4836M	D1207	H1459	P2606	ME28	-	UY128GAS #11
	364	M5364	E4837M	D1207	H1459	P2607			
F007H - W522 / FE (FFC) /FR	240	M5240	E6024	D2221	H2267	P2814	ME28	MH41E	UY128GAS #11
	248	M5248	E6025	D2221	H2267	P2815			
	356	M5356	E6326	D2222	H2268	P3116	ME28	MH41E	UY128GAS #11
	364	M5364	E6327	D2222	H2268	P3117			
F007H - U522 / FE(FFC)/FR	240	M5240	E6024	D2221	H2267	P3314	ME28	-	UY128GAS #11
	248	M5248	E6025	D2221	H2267	P3315			
	356	M5356	E6326	D2222	H2268	P3616			
	364	M5364	E6327	D2222	H2268	P3617			
F007H - W512 / FE (FFC)	240	M5240	E1524	D1206	H1258	P2914	ME28	MH41E	UY128GAS #11
	248	M5248	E1525	D1206	H1258	P2915			
	356	M5356	E1826	D1207	H1259	P3216			
	364	M5364	E1827	D1207	H1259	P3217			

									
MODEL	SUB - CLASS	NEEDLE CLAMP	NEEDLE PLATE	MAIN FEED DOG	DIFF. FEED DOG	PRESSER FOOT	LOOPER	SPREADER	NEEDLE
機 型	規 格	針 座	針 板	主 送 具	差 送 具	押 具	勾 針	上 叉	針 號
F007H - U512 / FE (FFC)	240	M5240	E1524	D1206	H1258	P3414	ME28	-	UY128 GAS #11
	248	M5248	E1525	D1206	H1258	P3415			
	356	M5356	E1826	D1207	H1259	P3716			
	364	M5364	E1827	D1207	H1259	P3717			
C007H - U613 / FBP	256	M5356	E1836 L	D1207	H1259	P4000	ME28	-	UY128GAS#14-18
	264	M5364	E1837 L	D1207	H1259	P4001			UY128GAS#16-21
C007H - U712	264	M5264	E5827	D5207	H5259	P4117	ME28	-	TV*3 #11-16
C007H - U712/ FSP	264	M5264	E5827	D5207	H5259	P5117	FS03/04	-	TV*3 #11-16
C007H - U712/ FSR	264	M5264	E5927	D5307	H5359	P4217	FS03/04	-	TV*7 #12 - 14
C007H - W722 / FY	388	M4388	E6828	D6207	H6259	P6117	FS03/04/FY02	FY09	TV*7 #12
F007H - W922 / FW (FWP)	460	M5460	E1828	D1207	H1259	P2408	ME28	MH41E	SM1014B #10 (MY1014B #70, SY7256)

備註 / REMARK : 1. F007H - W/U 122A - 356 / P2406
364 / P2407

2. W222 A / FAC (FEC) 短切刀 SHORT KNIFE
W222 / FAC (FEC) 長切刀 LONG KNIFE

3. F007H - W/U 322A - 356 / FDC E1826 / D1207 / H1259
364 / FDC E1827 / D1207 / H1259

PARTS LIST FOR MA(1) GROUP

PARTS LIST FOR MA(2) GROUP

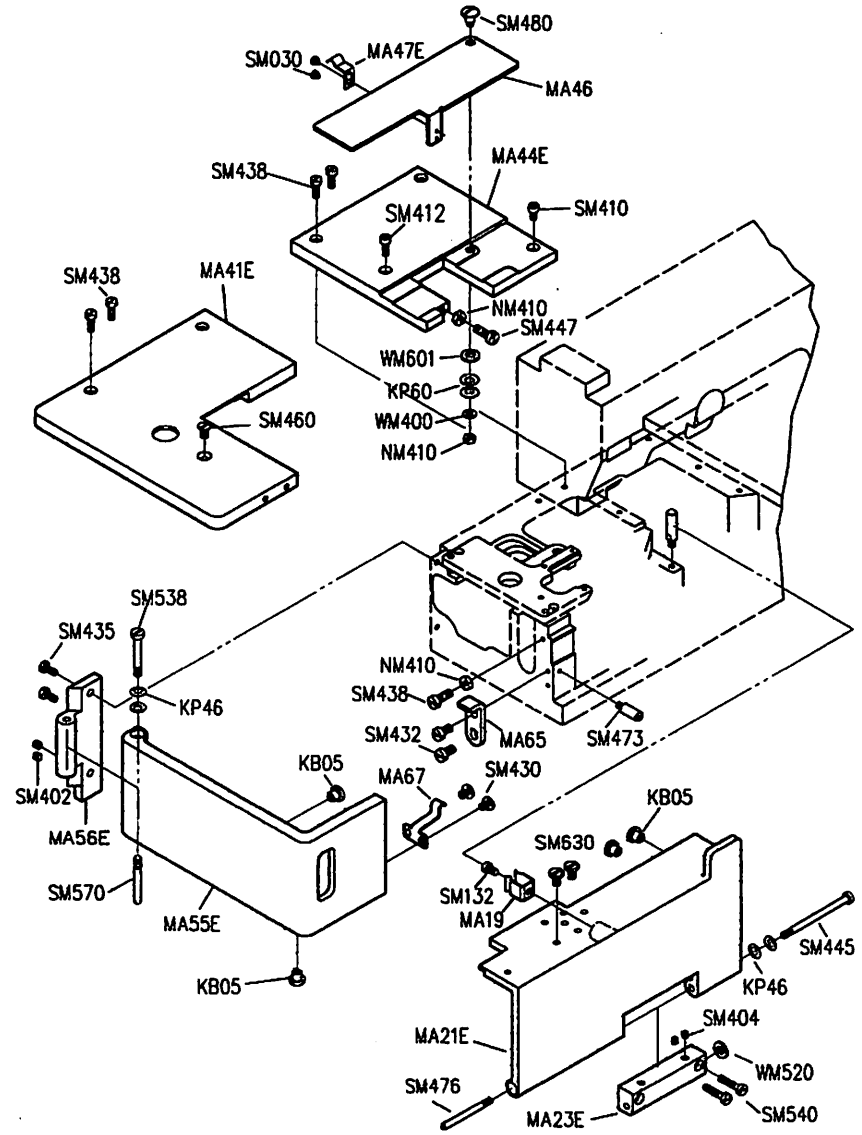
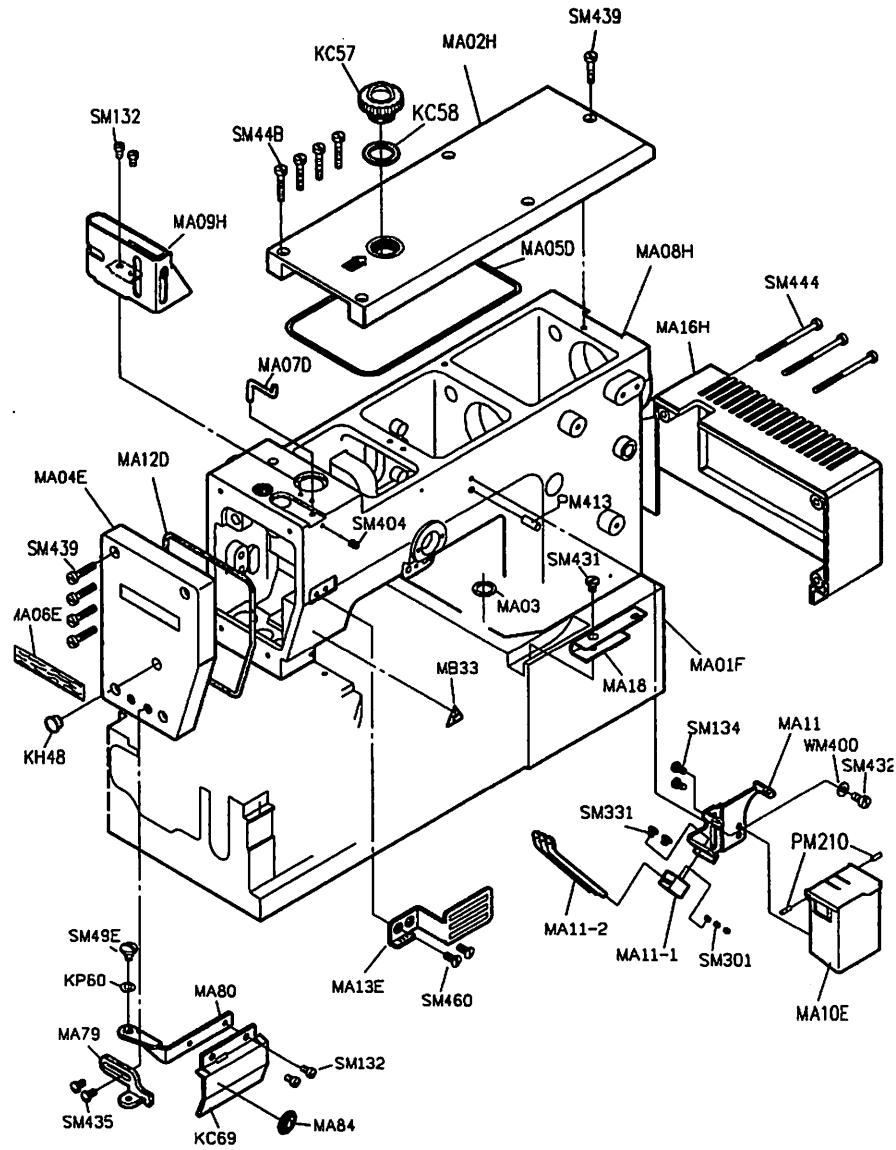

PARTS LIST FOR MC(2) GROUP

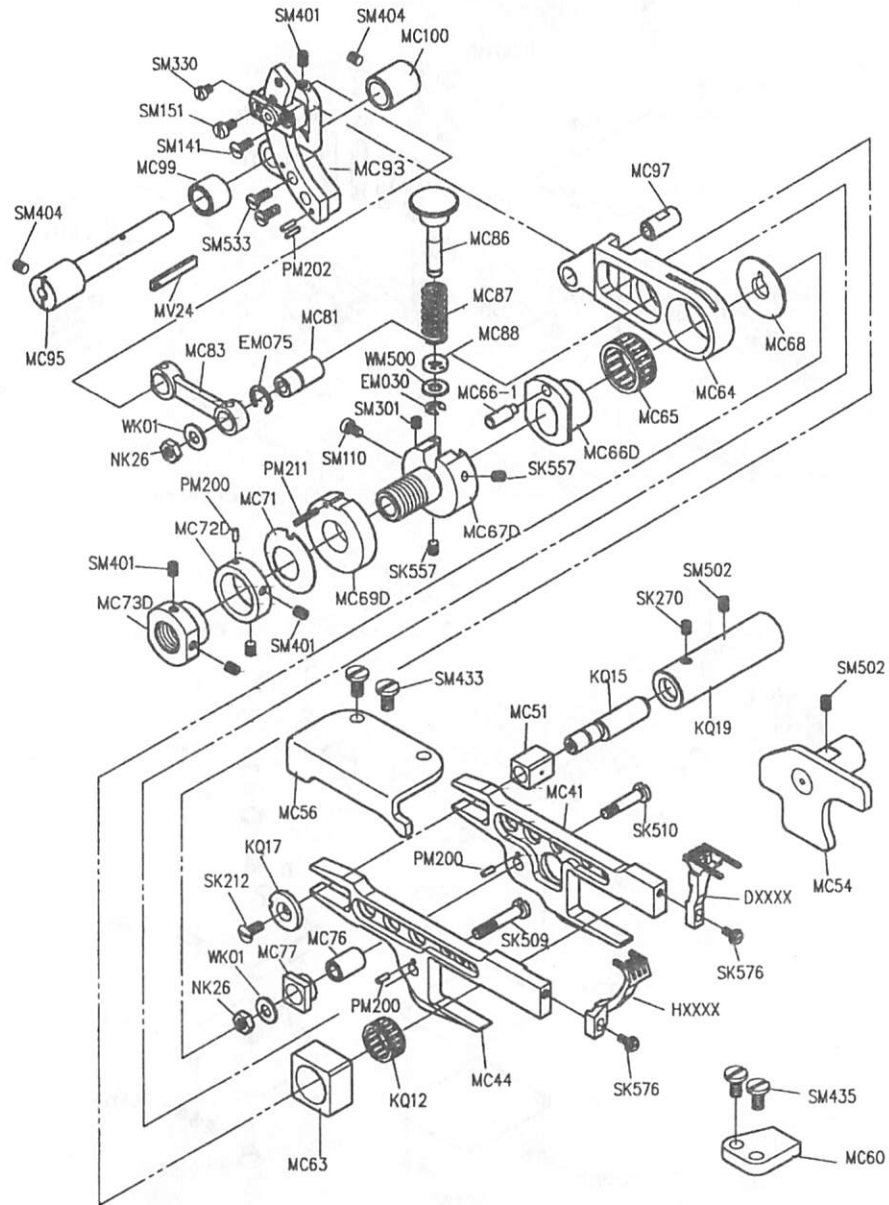

PARTS LIST FOR MD GROUP

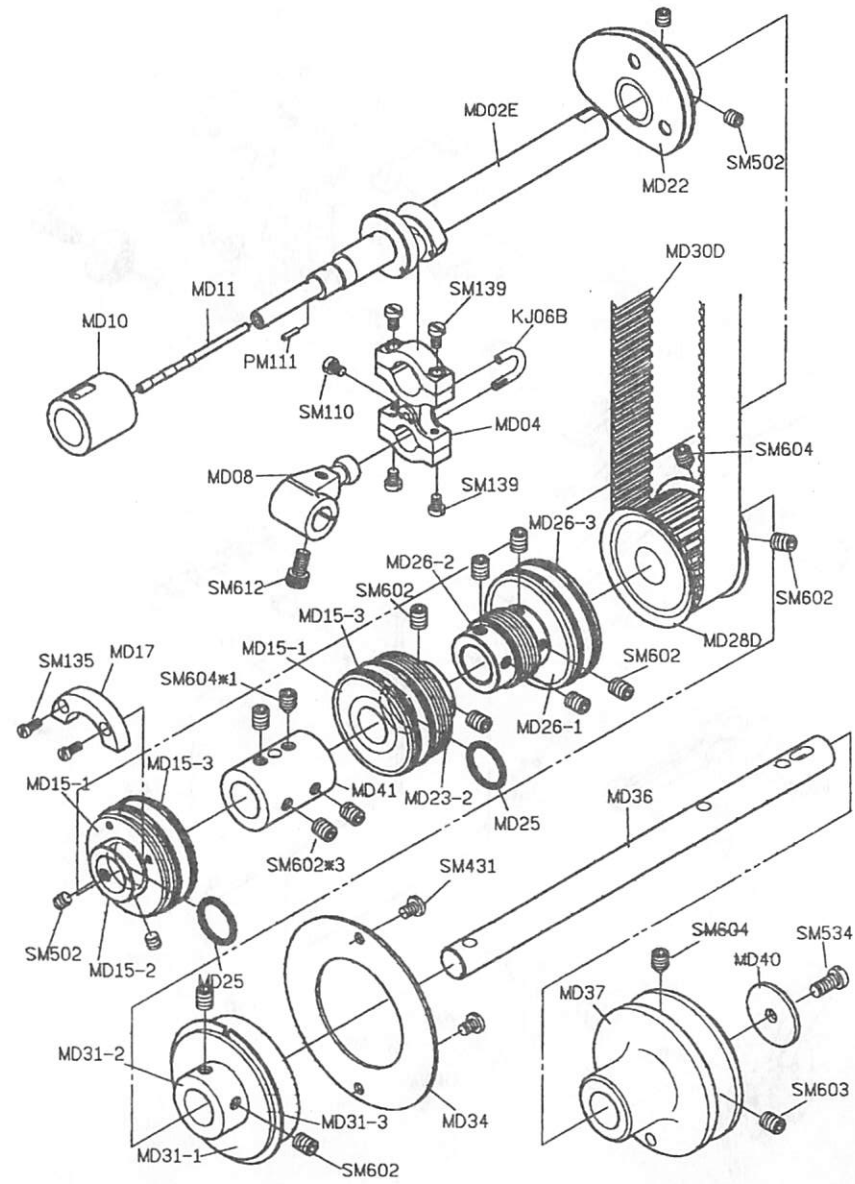

PARTS LIST FOR MG GROUP

PARTS LIST FOR MH GROUP

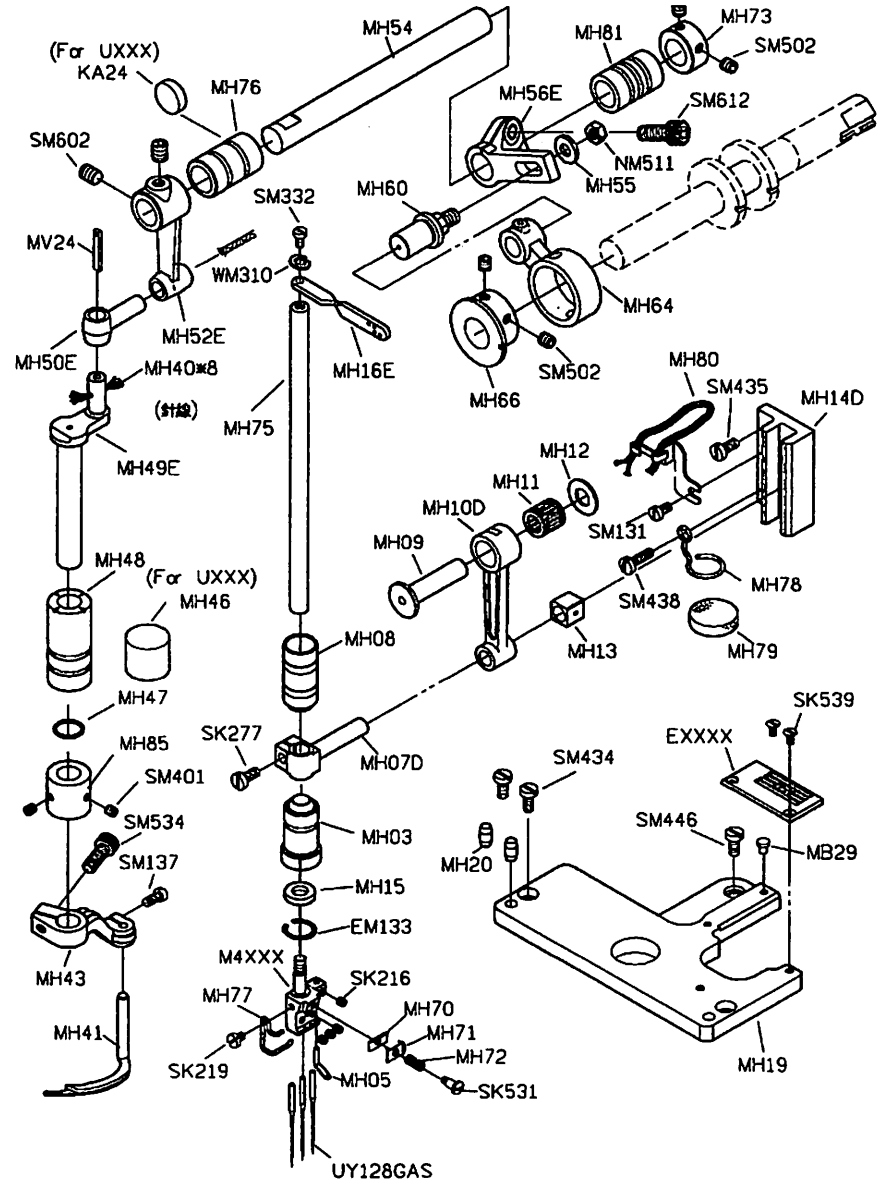
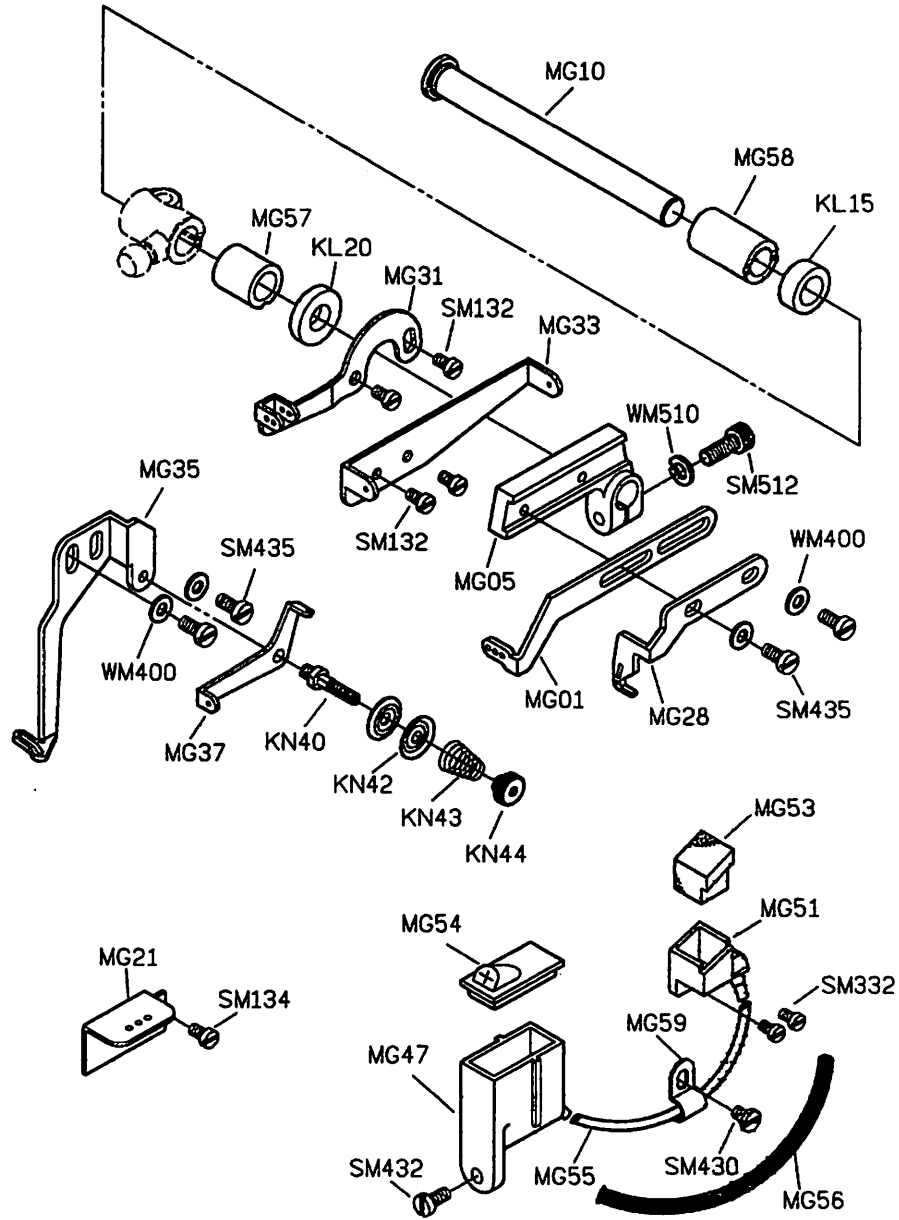

PARTS LIST FOR MK(2) GROUP

PARTS LIST FOR ML GROUP

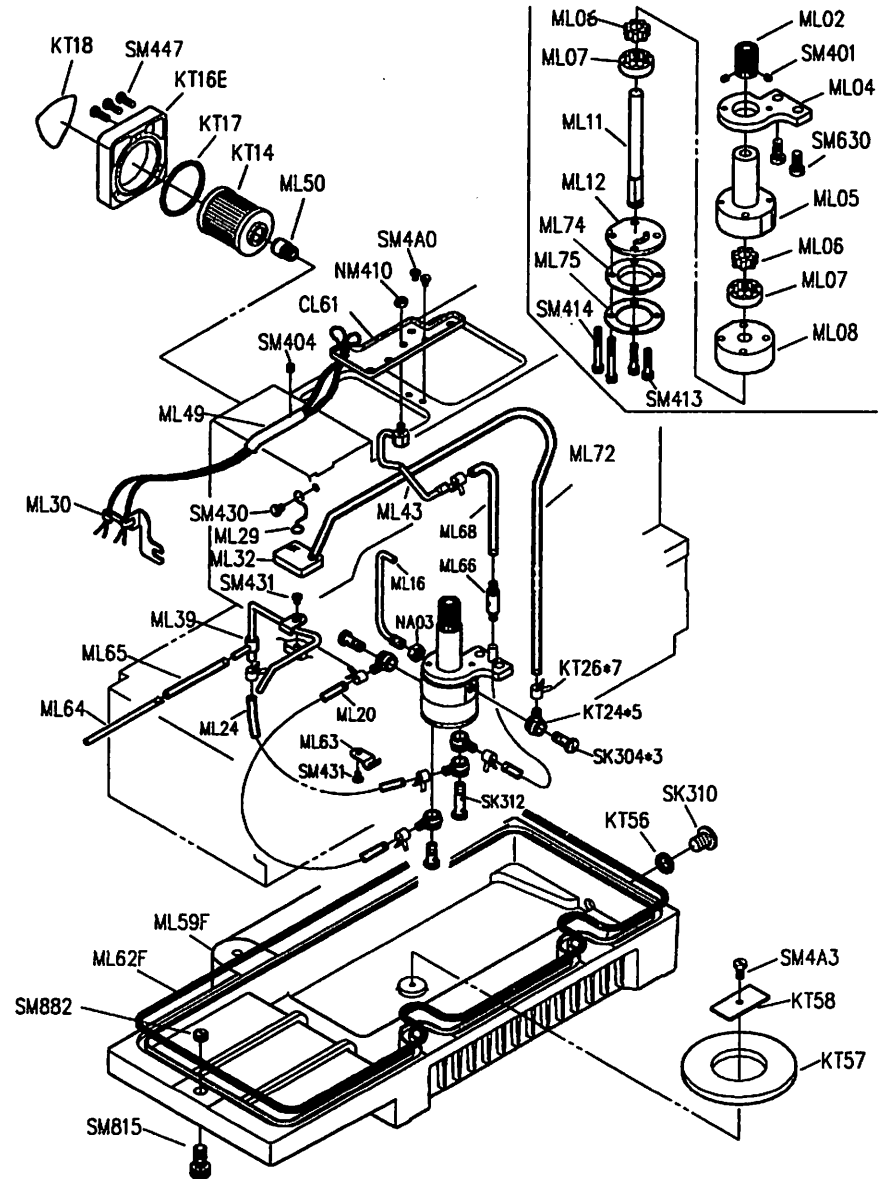
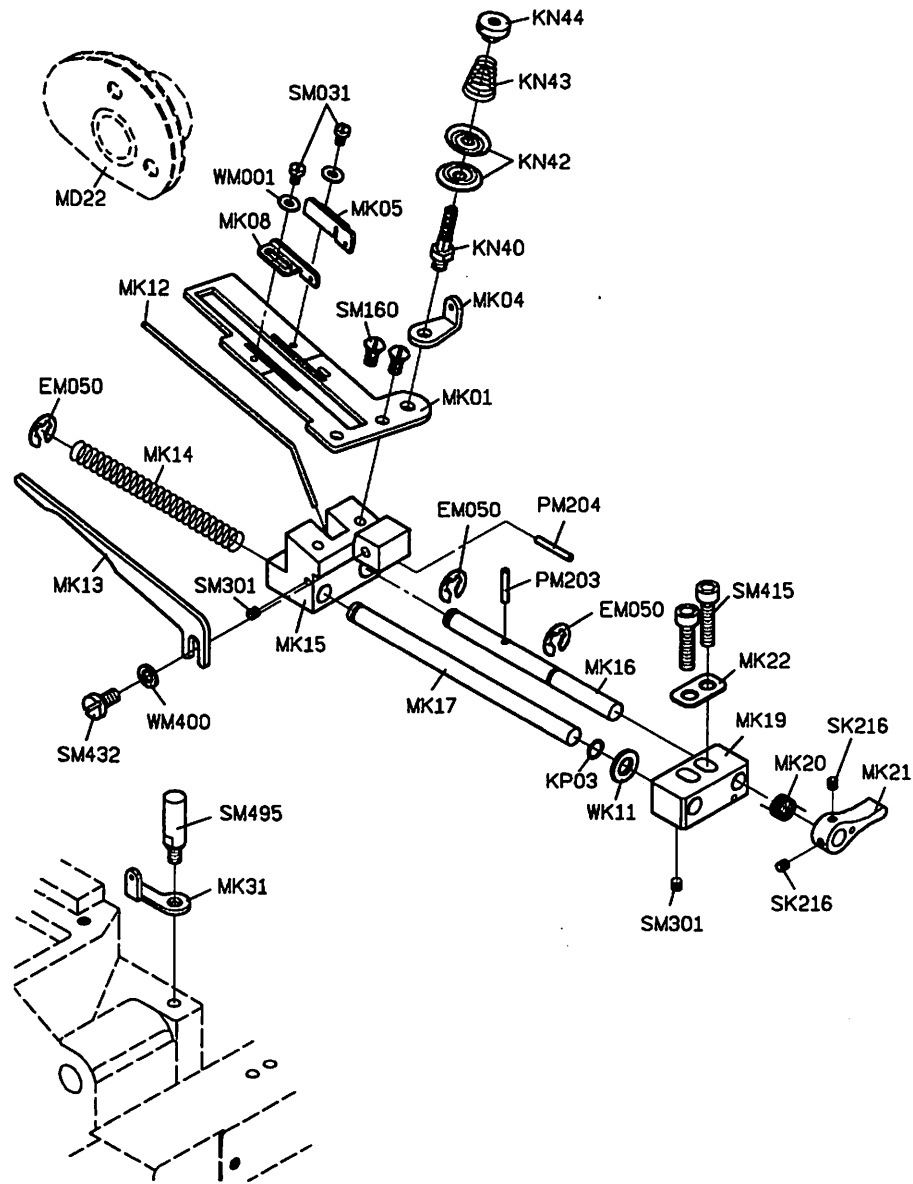

PARTS LIST FOR MN(1) GROUP

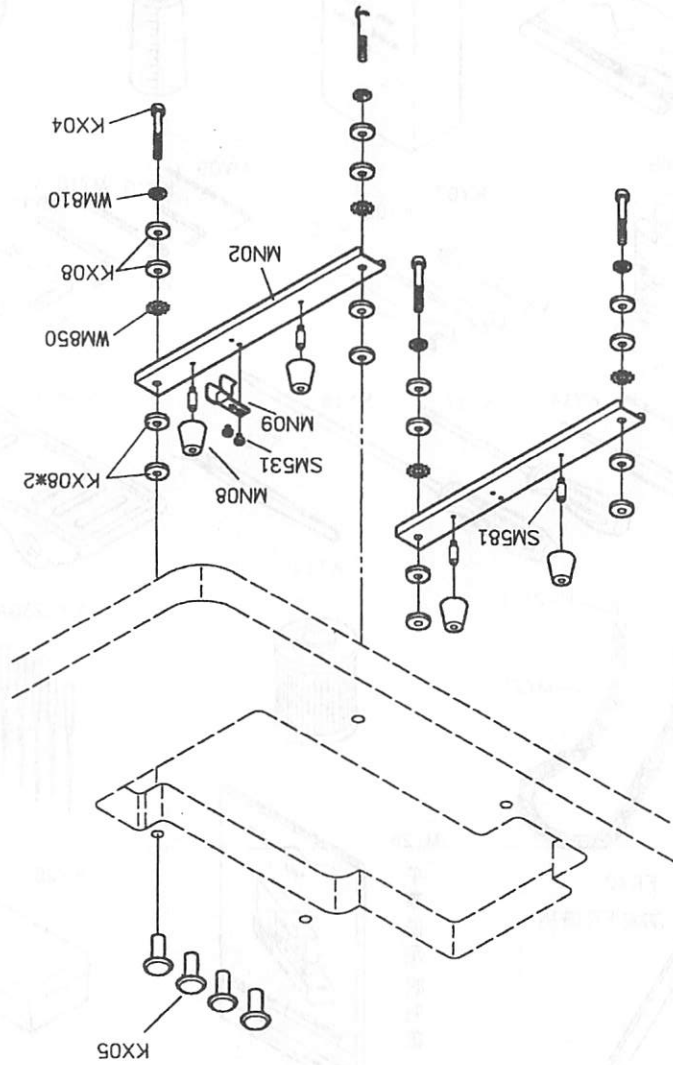

PARTS LIST FOR MN(2) GROUP

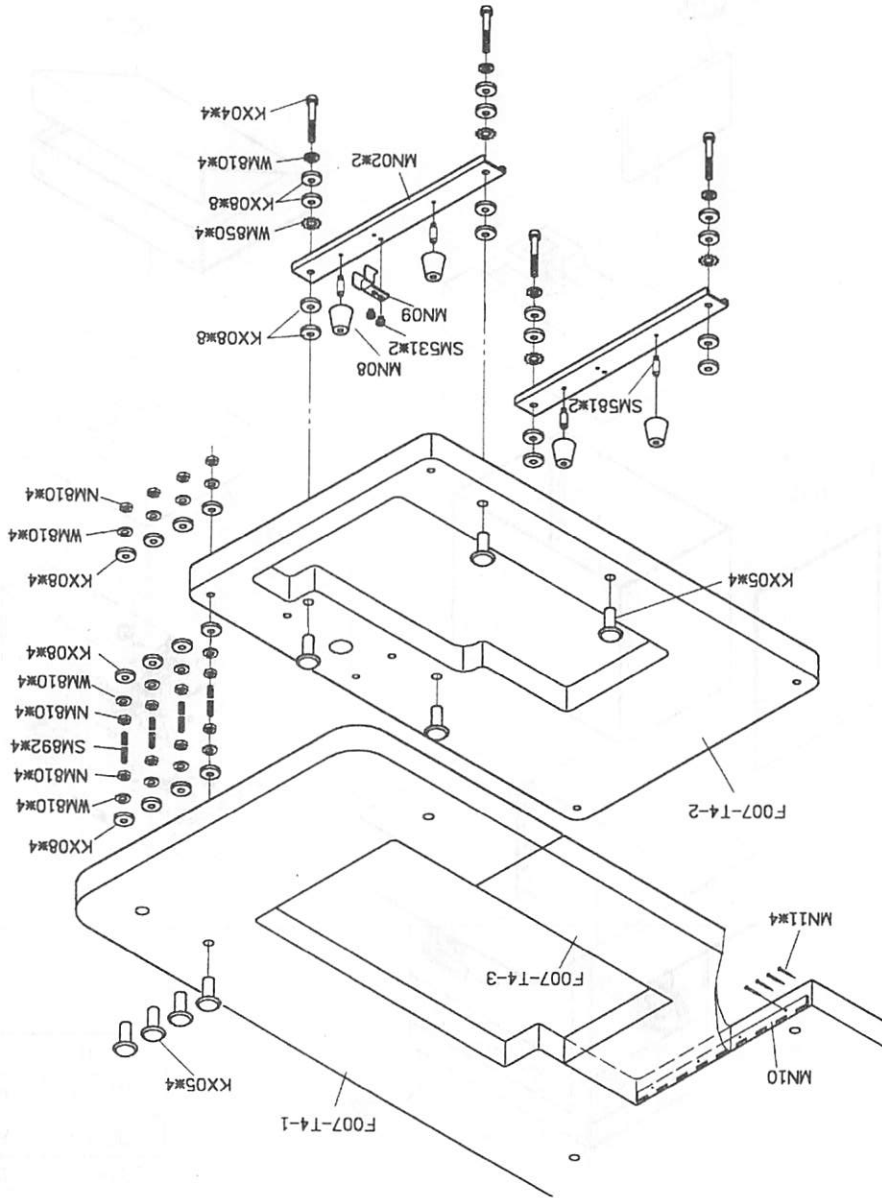

PARTS LIST FOR MY GROUP

PARTS LIST FOR MZ GROUP

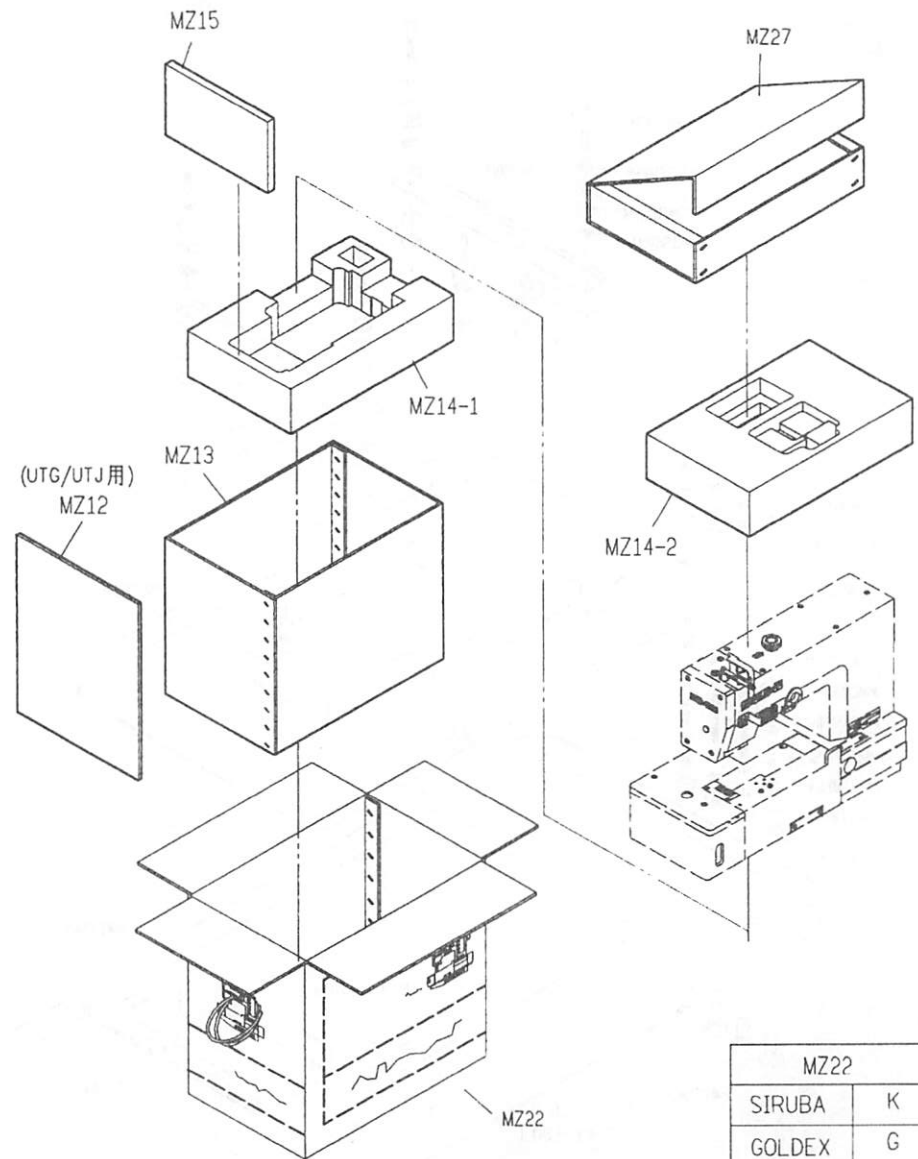
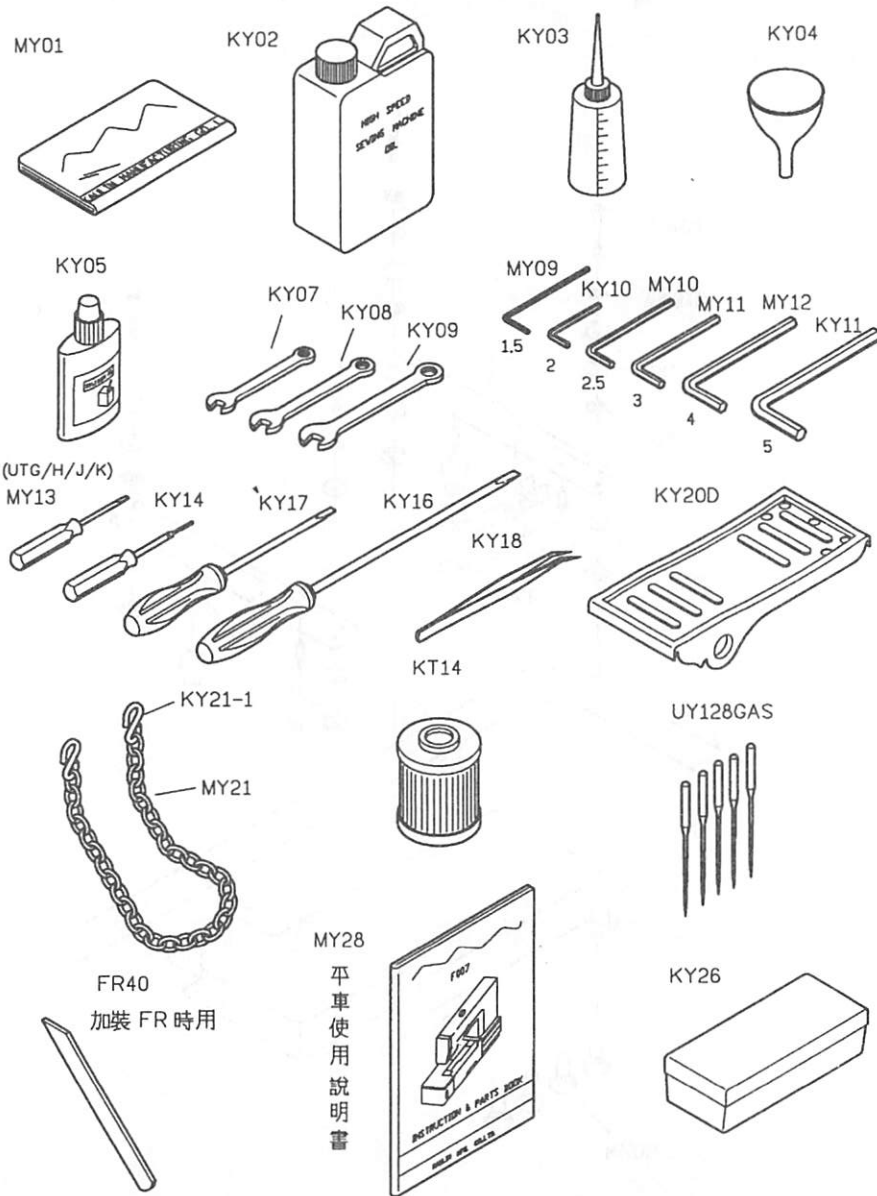

MZ22	
SIRUBA	K
GOLDEX	G
TAIKO	T

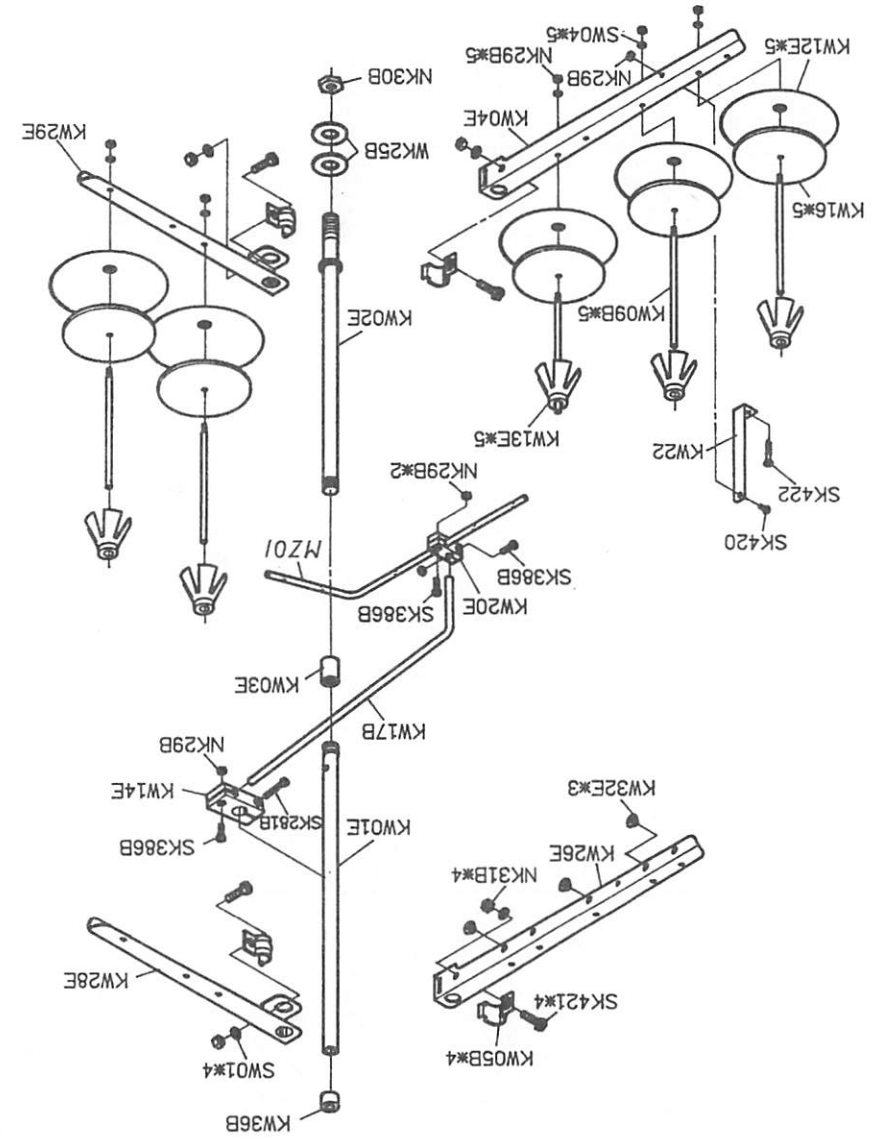



F007_H

高林股份有限公司 KAULIN MFG. CO., LTD.

MY33H. OCT. 2000

From the library of Superior Sewing Machine & Supply LLC - www.supsew.com