

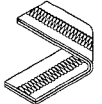

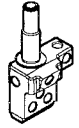

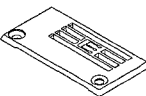

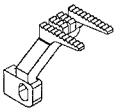

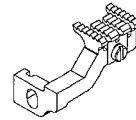
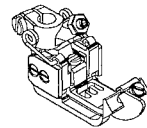
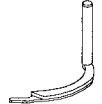

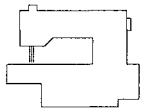
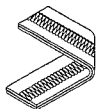
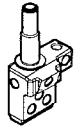
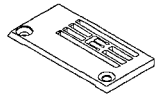
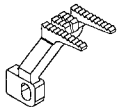
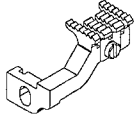
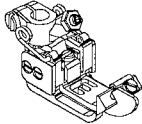
SIRUBA GAGE PARTS LIST		Series			Remark					Page	Date
		C007K / C858K C007KD / C858KD								1 / 7	2015/11/26
											
MODEL		SUB-CLASS	NEEDLE CLAMP	NEEDLE PLATE	MAIN FEED DOG	DIFF. FEED DOG	PRESSER FOOT	SPREADER	LOOPER	NEEDLE	
機 型		規 格	針 座	針 板	主 送 具	差 送 具	押 具	上 叉	勾 針	針 號	
C007K(KD) C858K(KD)	W121/CH	232 240 248 348 356 364	M5232 M5240 M5248 M5348 M5356 M5364	E5232KL E5240KL E5248KL E5348KL E5356KL E5364KL	D5356K	H5356KA-E	P5232A-A P5240A-A P5248A-A P5348A-A P5356A-A1 P5364A-A1	MH41	MT01	UYX128GAS#10	
	W122/CH			E5232KM E5240KM E5248KM E5348KM E5356KM E5364KM							
	W122/CH-3M	356 364	M5356 M5364	E5356KM E5364KM							
	W123/CH	232 240 248 348 356 364	M5232 M5240 M5248 M5348 M5356 M5364	E5232KH E5240KH E5248KH E5348KH E5356KH E5364KH							
	W152/CZ/UTP/RLQ	356 364	M5356 M5364	E5356GM E5364GM	D5356G	H5356L	P2416-A P2417-A				
	W152/CZP/RLQ										



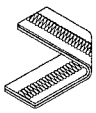
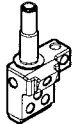
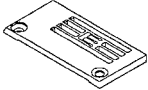
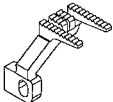
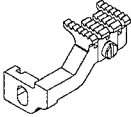
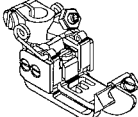

SIRUBA MODEL COMPARE LIST		Series				Remark			Page	Date
		C007K / C858K C007KD / C858KD							2 / 7	2015/11/26
MODEL		SUB-CLASS	NEEDLE CLAMP	NEEDLE PLATE	MAIN FEED DOG	DIFF. FEED DOG	PRESSER FOOT	SPREADER	LOOPER	NEEDLE
機 型		規 格	針 座	針 板	主 送 具	差 送 具	押 具	上 叉	勾 針	針 號
C007K(KD) C858K(KD)	W162/CH	240 248 348 356 364	M5240 M5248 M5348 M5356 M5364	E5240KHA E5248KHA E5348KHA E5356KHA E5364KHA	D5356K	H5356KA-E	P5240A-A P5248A-A P5348A-A P5356A-A1 P5364A-A1	MH41	MT01A	TV*5#14~16
	W222/CQ	240 248 356 364	M5240 M5248 M5356 M5364	E5240GM E5248GM E5356GM E5364GM	D5356G	H5356GA	P1814K-A P1815K-A P2116K-A P2117K-A	MH41	MT01	UYX128GAS#10
	W222/CQA/CLA	256 356	M5356	E2326Q	D2110	H2220Q	P2906Q-A	MH41	MT01A	TVX5#14
	W322/CC	356 364	M5356	E5356AM E5364AM	D5356K	H5356AA	P2456-A P2457-A	MH41	MT01	UYX128GAS#10
	W322/CE		M5364	E5356BM E5364BM		H5356BA				
C007K C858K	W512/FE(FFC)	232 240 356 364	M5232 M5240 M5356 M5364	E5232FM E5240FM E5356FM E5364FM	D5356K	H5356KA-E	P2913-A P2914-A P3216-A P3217-A	—	MT01	UYX128GAS#10
	U512/FE(FFC)	240 356 364	M5240 M5356 M5364	E5240FM E5356FM E5364FM			P3414-A P3716-A P3717-A			





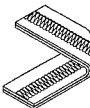
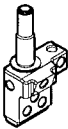
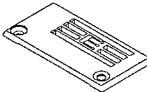
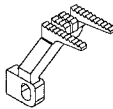
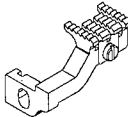
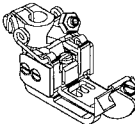

SIRUBA GAGE PARTS LIST		Series					Remark			Page	Date
		C007K / C858K C007KD / C858KD								3 / 7	2015/11/26
											
MODEL		SUB-CLASS	NEEDLE CLAMP	NEEDLE PLATE	MAIN FEED DOG	DIFF. FEED DOG	PRESSER FOOT	SPREADER	LOOPER	NEEDLE	
機 型		規 格	針 座	針 板	主 送 具	差 送 具	押 具	上 叉	勾 針	針 號	
C007K C858K	W522/FE(FFC)/CR						P3813R-A1 P5240C-A1 P5248C-A1 P5348C-A1 P3816R-A1 P3817R-A1				
C007K(KD) C858K(KD)	W522/CR	232 240 248 348 356 364	M5232 M5240 M5248 M5348 M5356 M5364	E5232CH E5240CH E5232CH E5348CH E5356CH E5364CH	D5356C	H5356CA	P5232R-A P5240R-A P5248R-A P5348R-A P5356R-A P5364R-A	MH41	MT01	UYX128GAS#10	
	W532/CR/UTP/CL/RLP/CX										
C007K C858K	W542/CFC/CL/FH/2(3A)	240 248 356 364	M5240 M5248 M5356 M5364	E2324P E2325P E2326P E2327P	D2109 D2110	H2219 H2220	P2904-A P2905-A P2906-A P2907-A				
C007K(KD) C858K(KD)	W811/CRL	232 240 248 356 364	M5232 M5240 M5248 M5356 M5364	E5232ML E5240ML E5248ML E5356ML E5364ML	D5356H	H5356MA	P2763-A P2764-A P2765-A P2766-A P2767-A	—			
	U811/CRL										

SIRUBA MODEL COMPARE LIST		Series			Remark					Page	Date
		C007K / C858K C007KD / C858KD			W812 /W813 : 4rof teeth W812A/W813A : 5rof teeth					4 / 7	2015/11/26
MODEL		SUB-CLASS	NEEDLE CLAMP	NEEDLE PLATE	MAIN FEED DOG	DIFF. FEED DOG	PRESSER FOOT	SPREADER	LOOPER	NEEDLE	
機 型		規 格	針 座	針 板	主送具	差送具	押 具	上 叉	勾 針	針 號	
C007K(KD) C858K(KD)	W811A/CRL	232 240 248 356 364	M5232 M5240 M5248 M5356 M5364	E5232NL E5240NL E5248NL E5356NL E5364NL	D5356H	H5356NA	P2763-A P2764-A P2765-A P2766-A P2767-A	MH41	MT01	UYX128GAS#10	
	U811A/CRL						P0963-A P0964-A P0965-A P0966-A P0967-A	—			
	W812/CRL			P2763-A P2764-A P2765-A P2766-A P2767-A		MH41					
	U812/CRL			P0963-A P0964-A P0965-A P0966-A P0967-A		—					
	W812A/CRL			P2763-A P2764-A P2765-A P2766-A P2767-A		MH41					
	U812A/CRL			P0963-A P0964-A P0965-A P0966-A P0967-A		—					



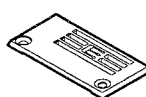
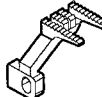
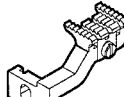
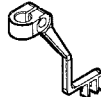
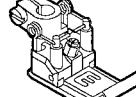

SIRUBA MODEL COMPARE LIST		Series				Remark				Page	Date
		C007K / C858K C007KD / C858KD				W812 /W813 : 4rof teeth W812A/W813A : 5rof teeth				5 / 7	2015/11/26
											
MODEL		SUB-CLASS	NEEDLE CLAMP	NEEDLE PLATE	MAIN FEED DOG	DIFF. FEED DOG	PRESSER FOOT	SPREADER	LOOPER	NEEDLE	
機 型		規 格	針 座	針 板	主 送 具	差 送 具	押 具	上 叉	勾 針	針 號	
C007K(KD) C858K(KD)	W813/CRL	232 240 248 356 364	M5232 M5240 M5248 M5356 M5364	E5232MH E5240MH E5248MH E5356MH E5364MH	D5356H	H5356MA	P2763-A P2764-A P2765-A P2766-A P2767-A	MH41	MT01	UYX128GAS#10	
	U813/CRL						P0963-A P0964-A P0965-A P0966-A P0967-A	—			
	W813A/CRL			E5232NH E5240NH E5248NH E5356NH E5364NH		H5356NA	P2763-A P2764-A P2765-A P2766-A P2767-A	MH41			
	U813A/CRL						P0963-A P0964-A P0965-A P0966-A P0967-A	—			
	W821/CRL/CHP/UTP/CL/RL			E5232ML E5240ML E5248ML E5356ML E5364ML		H5356MA	P2763-A P2764-A P2765-A P2766-A P2767-A	MH41			
	U821/CRL/CHP/UTP/CL/RL						P0963-A P0964-A P0965-A P0966-A P0967-A	—			



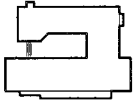
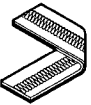
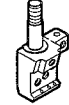
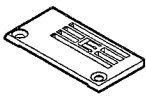
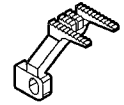
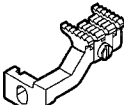
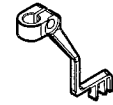
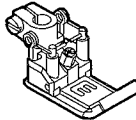

SIRUBA GAGE PARTS LIST		Series				Remark			Page	Date
		C007K / C858K C007KD / C858KD							6 / 7	2015/11/26
MODEL		SUB-CLASS	NEEDLE CLAMP	NEEDLE PLATE	MAIN FEED DOG	DIFF. FEED DOG	PRESSER FOOT	SPREADER	LOOPER	NEEDLE
機 型		規 格	針 座	針 板	主 送 具	差 送 具	押 具	上 叉	勾 針	針 號
C007K(KD) C858K(KD)	W821A/CRL/CHP/UTP/CL/RL	232 240 248 356 364	M5232 M5240 M5248 M5356 M5364	E5232NL E5240NL E5248NL E5356NL E5364NL	D5356H	H5356NA	P2763-A P2764-A P2765-A P2766-A P2767-A	MH41	MT01	UYX128GAS#10
	U821A/CRL/CHP/UTP/CL/RL						P0963-A P0964-A P0965-A P0966-A P0967-A	—		
	W822/CRL/CHP/UTP/CL/RL			E5232MM E5240MM E5248MM E5356MM E5364MM		H5356MA	P2763-A P2764-A P2765-A P2766-A P2767-A	MH41		
	U822/CRL/CHP/UTP/CL/RL						P0963-A P0964-A P0965-A P0966-A P0967-A	—		
	W822A/CRL/CHP/UTP/CL/RL			E5232NM E5240NM E5248NM E5356NM E5364NM		H5356NA	P2763-A P2764-A P2765-A P2766-A P2767-A	MH41		
	U822A/CRL/CHP/UTP/CL/RL						P0963-A P0964-A P0965-A P0966-A P0967-A	—		



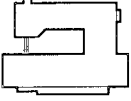
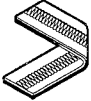
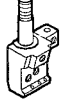
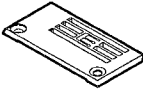
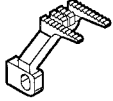
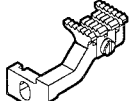
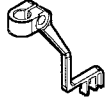
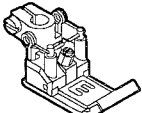

SIRUBA GAGE PARTS LIST		Series				Remark			Page	Date
		C007K / C858K C007KD / C858KD							7/7	2015/11/26
										
MODEL		SUB-CLASS	NEEDLE CLAMP	NEEDLE PLATE	MAIN FEED DOG	DIFF. FEED DOG	PRESSER FOOT	SPREADER	LOOPER	NEEDLE
機 型		規 格	針 座	針 板	主 送 具	差 送 具	押 具	上 叉	勾 針	針 號
C007K(KD) C858K(KD)	W823/CRL/CHP/UTP/CL/RL			E5232MH E5240MH E5248MH E5356MH E5364MH		H5356MA	P2763-A P2764-A P2765-A P2766-A P2767-A	MH41		
	U823/CRL/CHP/UTP/CL/RL						P0963-A P0964-A P0965-A P0966-A P0967-A	—		
	W823A/CRL/CHP/UTP/CL/RL	232 240 248 356 364	M5232 M5240 M5248 M5356 M5364	E5232NH E5240NH E5248NH E5356NH E5364NH	D5356H	H5356NA	P2763-A P2764-A P2765-A P2766-A P2767-A	MH41	MT01	UYX128GAS#10
	U823A/CRL/CHP/UTP/CL/RL	P0963-A P0964-A P0965-A P0966-A P0967-A	—							
	W922/CW	456 460 464	M5456K M5460K M5464K	E5456KM E5460KM E5464KM	D5456K	H5456KA-E	P5456K-A P5460K-A P5464K-A	MH41	MT01B	SM1014B#10

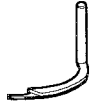
SIRUBA GAGE PARTS LIST		Series				Remark					Page	Date
		C007KD				USE FOR FFT					1 / 4	2015/11/24
												
MODEL	SUB-CLASS	NEEDLE CLAMP	NEEDLE PLATE	MAIN FEED DOG	DIFF. FEED DOG	TOP FEED DOG	PRESSER FOOT	LOOPER	SPREADER	NEEDLE		
機 型	規 格	針 座	針 板	主送具	差送具	上送具	壓 具	勾 針	上 叉	使用針		
W121/FFT/CH	240 248 356 364	M5240 M5248 M5356 M5364	E5240KL E5248KL E5356KL E5364KL	D5356K	H5356KA-E	F7356N	P7240N-A P7248N-A P7356N-A P7364N-A	MT01	MH41	UYX128GAS#10		
W121/FFT/CH /UTP(UTR)	240 248 356 364	M5240 M5248 M5356 M5364	E5240KL E5248KL E5356KL E5364KL	D5356K	H5356KA-E	F7356N	P7240N-A P7248N-A P7356N-A P7364N-A	MT01	MH41	UYX128GAS#10		
W122/FFT/CH	240 248 356 364	M5240 M5248 M5356 M5364	E5240KM E5248KM E5356KM E5364KM	D5356K	H5356KA-E	F7356N	P7240N-A P7248N-A P7356N-A P7364N-A	MT01	MH41	UYX128GAS#10		
W122/FFT/CH /UTP(UTR)	240 248 356 364	M5240 M5248 M5356 M5364	E5240KM E5248KM E5356KM E5364KM	D5356K	H5356KA-E	F7356N	P7240N-A P7248N-A P7356N-A P7364N-A	MT01	MH41	UYX128GAS#10		

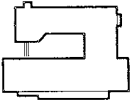
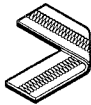
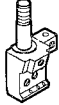
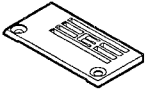
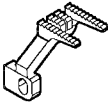
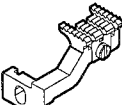
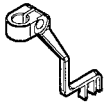
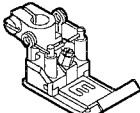

SIRUBA GAGE PARTS LIST		Series				Remark					Page	Date
		C007KD				USE FOR FFT					2 / 4	2015/11/24
												
MODEL	SUB-CLASS	NEEDLE CLAMP	NEEDLE PLATE	MAIN FEED DOG	DIFF. FEED DOG	TOP FEED DOG	PRESSER FOOT	LOOPER	SPREADER	NEEDLE		
機 型	規 格	針 座	針 板	主送具	差送具	上送具	壓 具	勾 針	上 叉	使用針		
W131/FFT/CH	240 248 356 364	M5240 M5248 M5356 M5364	E7240CL E7248CL E7356CL E7364CL	D7356C	H7356CA	F7356F	P7240F-A P7248F-A P7356F-A P7364F-A	MT01	MH41	UYX128GAS#10		
W131/FFT/CH /UTP(UTR)	240 248 356 364	M5240 M5248 M5356 M5364	E7240CL E7248CL E7356CL E7364CL	D7356C	H7356CA	F7356F	P7240F-A P7248F-A P7356F-A P7364F-A	MT01	MH41	UYX128GAS#10		
W132/FFT/CH	240 248 356 364	M5240 M5248 M5356 M5364	E7240CM E7248CM E7356CM E7364CM	D7356C	H7356CA	F7356F	P7240F-A P7248F-A P7356F-A P7364F-A	MT01	MH41	UYX128GAS#10		
W132/FFT/CH /UTP(UTR)	240 248 356 364	M5240 M5248 M5356 M5364	E7240CM E7248CM E7356CM E7364CM	D7356C	H7356CA	F7356F	P7240F-A P7248F-A P7356F-A P7364F-A	MT01	MH41	UYX128GAS#10		

SiRUBA GAGE PARTS LIST		Series				Remark					Page	Date
		C007KD				USE FOR FFT					3 / 4	2013/11/24
												
MODEL	SUB-CLASS	NEEDLE CLAMP	NEEDLE PLATE	MAIN FEED DOG	DIFF. FEED DOG	TOP FEED DOG	PRESSER FOOT	LOOPER	SPREADER	NEEDLE		
機 型	規 格	針 座	針 板	主送具	差送具	上送具	壓 具	勾 針	上 叉	使用針		
W811A/FFT/CRL	240 248 356 364	M5240 M5248 M5356 M5364	E5240NL E5248NL E5356NL E5364NL	D5356H	H5356NA	F7356L	P7240H-A P7248H-A P7356H-A P7364H-A	MT01	MH41	UYX128GAS#10		
U811A/FFT/CRL	240 248 356 364	M5240 M5248 M5356 M5364	E5240NL E5248NL E5356NL E5364NL	D5356H	H5356NA	F7356L	P7240L-A P7248L-A P7356L-A P7364L-A	MT01	—	UYX128GAS#10		
W811A/FFT/CRL /UTP(UTR)	240 248 356 364	M5240 M5248 M5356 M5364	E5240NL E5248NL E5356NL E5364NL	D5356H	H5356NA	F7356L	P7240H-A P7248H-A P7356H-A P7364H-A	MT01	MH41	UYX128GAS#10		
U811A/FFT/CRL /UTP(UTR)	240 248 356 364	M5240 M5248 M5356 M5364	E5240NL E5248NL E5356NL E5364NL	D5356H	H5356NA	F7356L	P7240L-A P7248L-A P7356L-A P7364L-A	MT01	—	UYX128GAS#10		
W812A/FFT/CRL	240 248 356 364	M5240 M5248 M5356 M5364	E5240NM E5248NM E5356NM E5364NM	D5356H	H5356NA	F7356L	P7240H-A P7248H-A P7356H-A P7364H-A	MT01	MH41	UYX128GAS#10		
U812A/FFT/CRL	240 248 356 364	M5240 M5248 M5356 M5364	E5240NM E5248NM E5356NM E5364NM	D5356H	H5356NA	F7356L	P7240L-A P7248L-A P7356L-A P7364L-A	MT01	—	UYX128GAS#10		
W812A/FFT/CRL /UTP(UTR)	240 248 356 364	M5240 M5248 M5356 M5364	E5240NM E5248NM E5356NM E5364NM	D5356H	H5356NA	F7356L	P7240H-A P7248H-A P7356H-A P7364H-A	MT01	MH41	UYX128GAS#10		

SIRUBA GAGE PARTS LIST		Series				Remark					Page	Date
		C007KD				USE FOR FFT					4 / 4	2015/11/24
												
MODEL	SUB-CLASS	NEEDLE CLAMP	NEEDLE PLATE	MAIN FEED DOG	DIFF. FEED DOG	TOP FEED DOG	PRESSER FOOT	LOOPER	SPREADER	NEEDLE		
機 型	規 格	針 座	針 板	主送具	差送具	上送具	壓 具	勾 針	上 叉	使用針		
U812A/FFT/CRL /UTP(UTR)	240 248 356 364	M5240 M5248 M5356 M5364	E5240NM E5248NM E5356NM E5364NM	D5356H	H5356NA	F7356L	P7240L-A P7248L-A P7356L-A P7364L-A	MT01	—	UYX128GAS#10		
W812A/FFT/CRL /CW/UTP(UTR)	356 364	M5456 M5464	E5456NM E5464NM	D5356H	H5356NA	F7356L	P7456H-A P7464H-A	MT01	MH41	SM1014B#10 (MY1014B#70,SY7256)		

<b>SIRUBA</b> PARTS LIST	Series	Parts Group	Subclass / Remark	Page
	C007K/C007KD C858K/C858KD	<b>MF-K</b>	#: Use for C007KD/C858KD	1/1
				Date
				2016/01/22

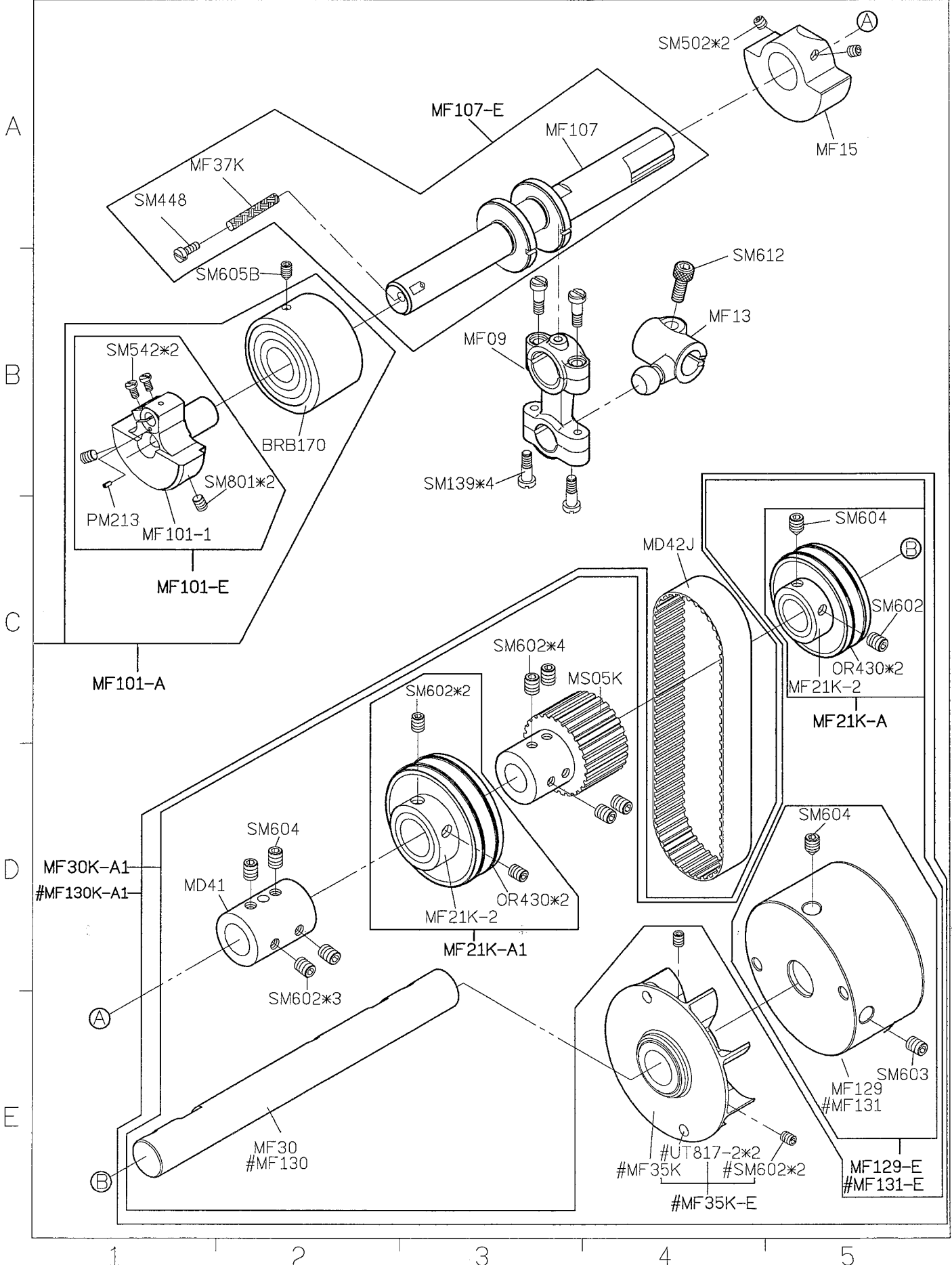

**SIRUBA**

PARTS LIST

Series

C007K/C007KD  
C858K/C858KD

Parts Group

**MG-K**

Subclass / Remark

Page

1/1

Date

2014/12/25

A

B

C

D

E

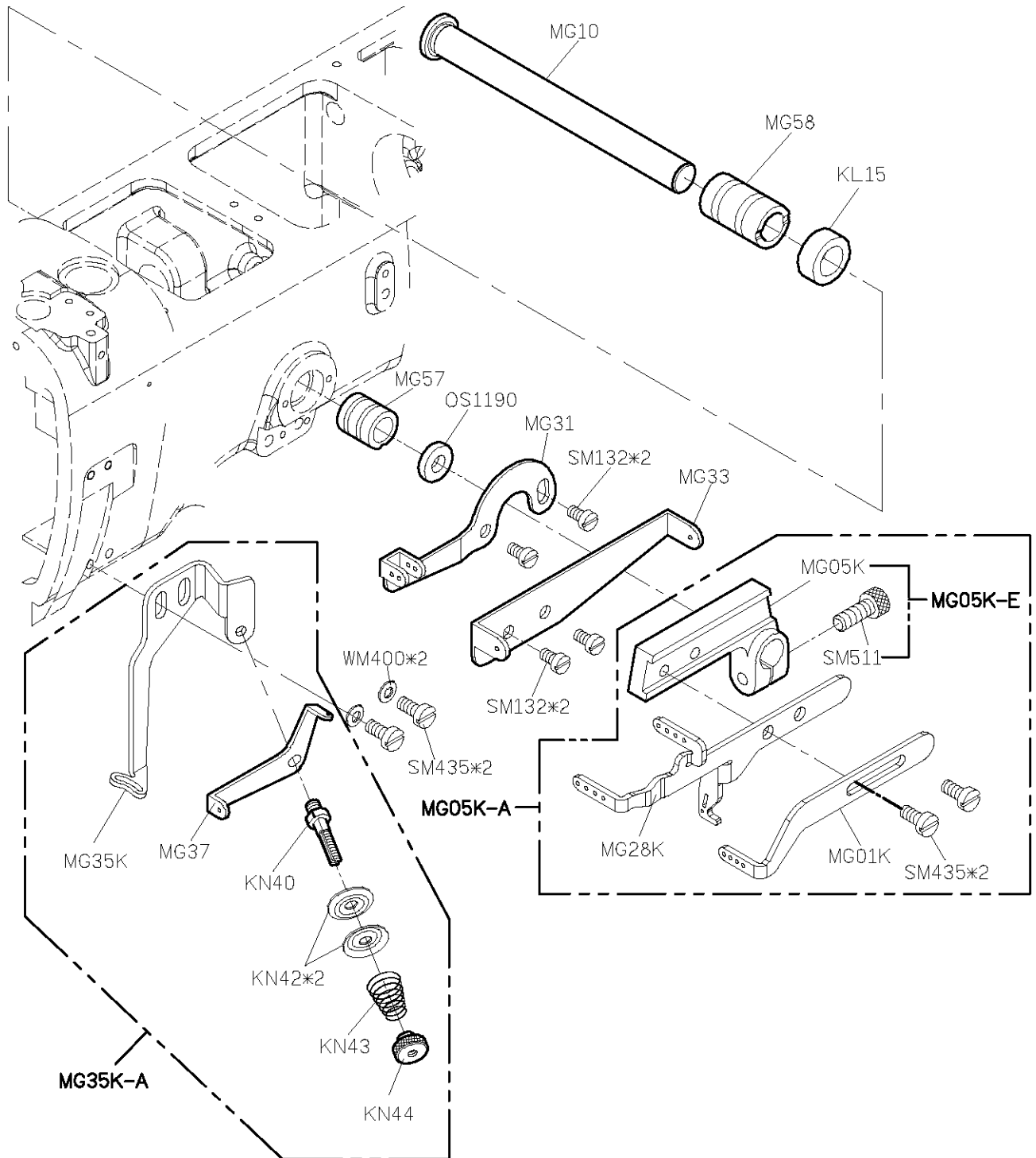

<b>SIRUBA</b> PARTS LIST	Series	Parts Group	Subclass / Remark	Page
	C007K/C007KD C858K/C858KD	<b>MH-K</b>		1/1
				Date
				2016/01/22

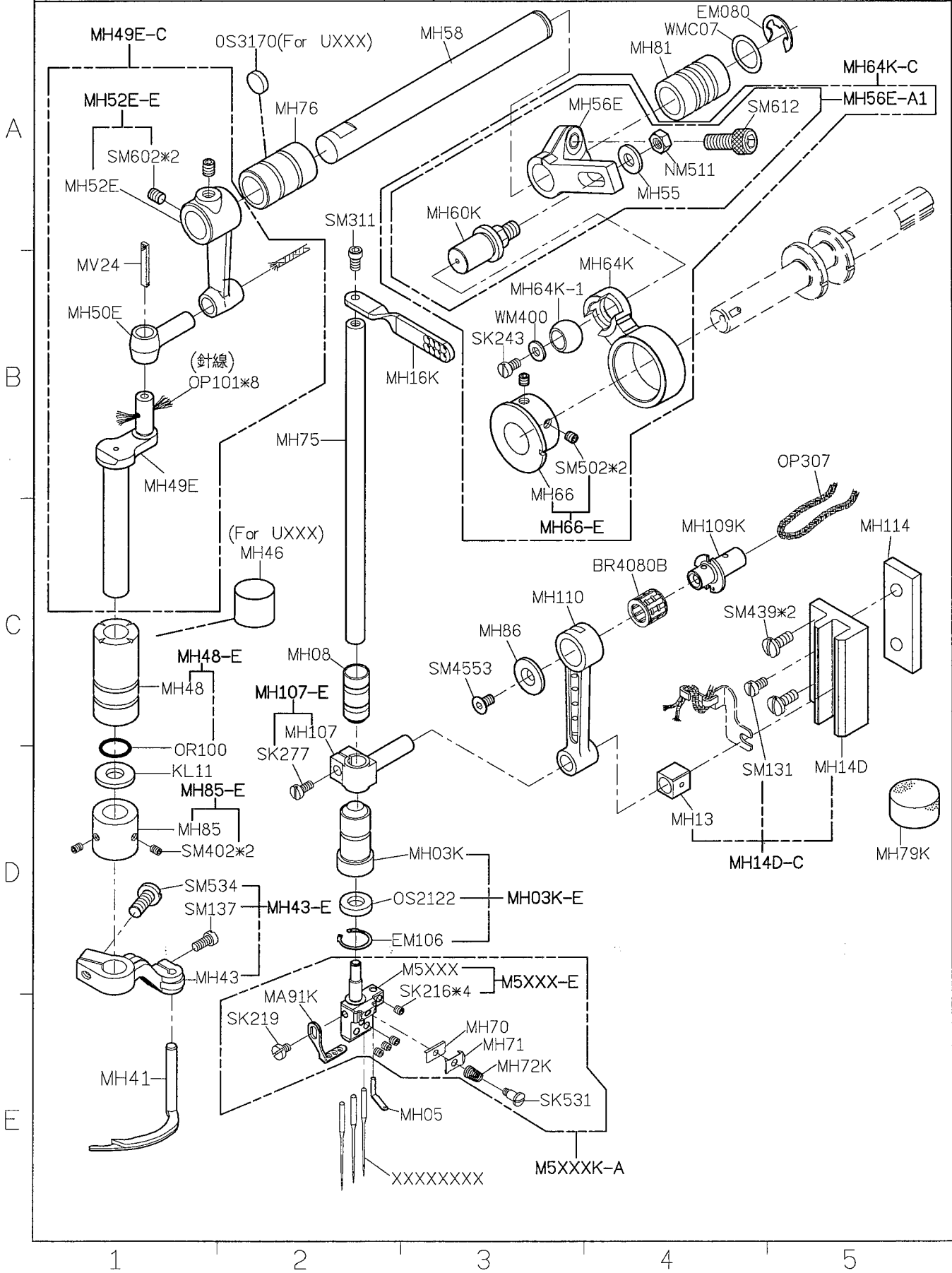

**SIRUBA**

PARTS LIST

Series

C007K/C007KD  
C858K/C858KD

Parts Group

**MJ-K**

Subclass / Remark

◎ : Use for C007K/C858K  
 ▼ : Use for C007K/C858K-UT  
 ◇ : Use for C007KD/C858KD-UT  
 # : Use for C007KD/C858KD not for UT

Page

1/1

Date

2015/01/09

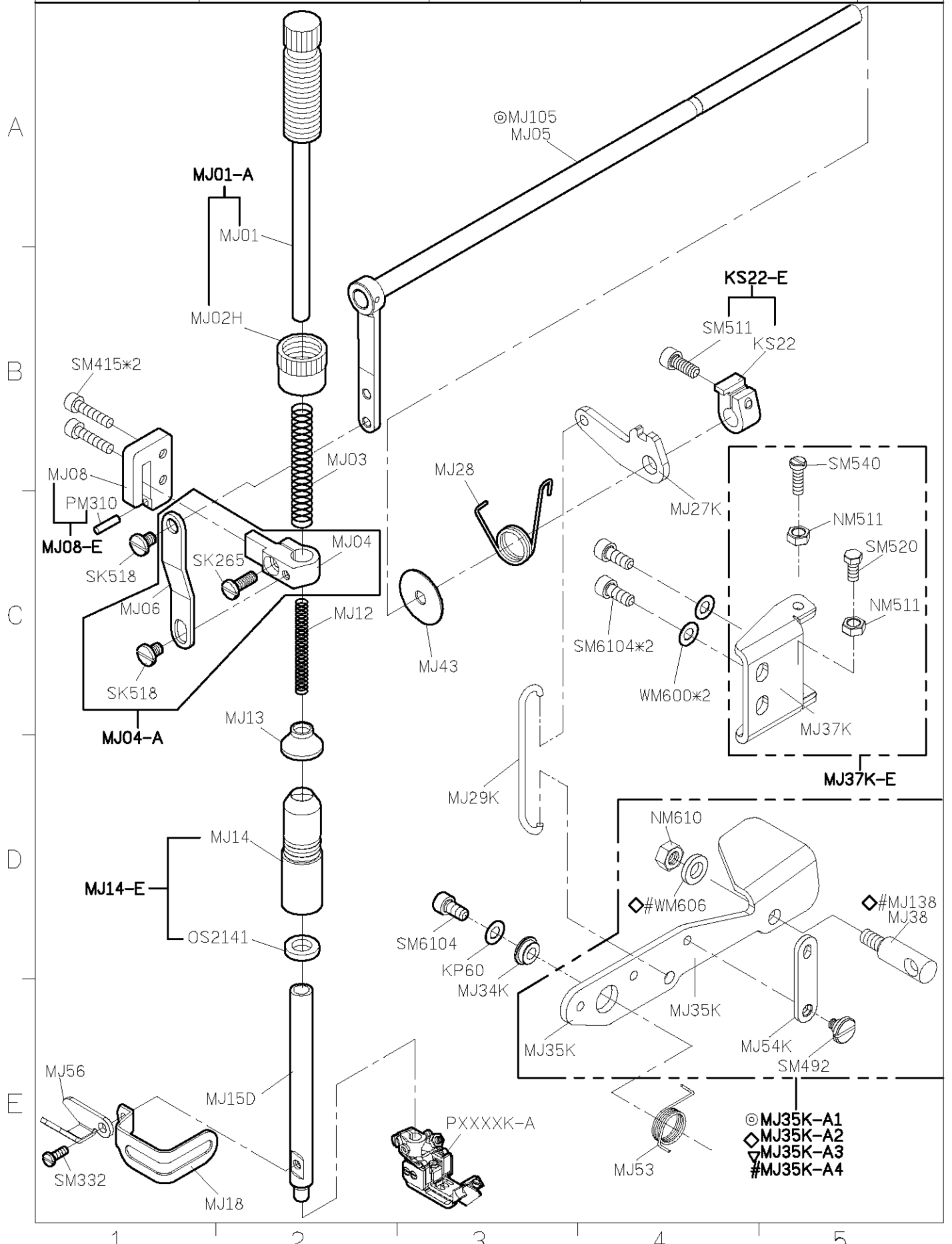



SIRUBA PARTS LIST	Series	Parts Group	Subclass / Remark	Page
	C007K/C007KD	MK-K		1/1
	C858K/C858KD			Date
				2015/12/28

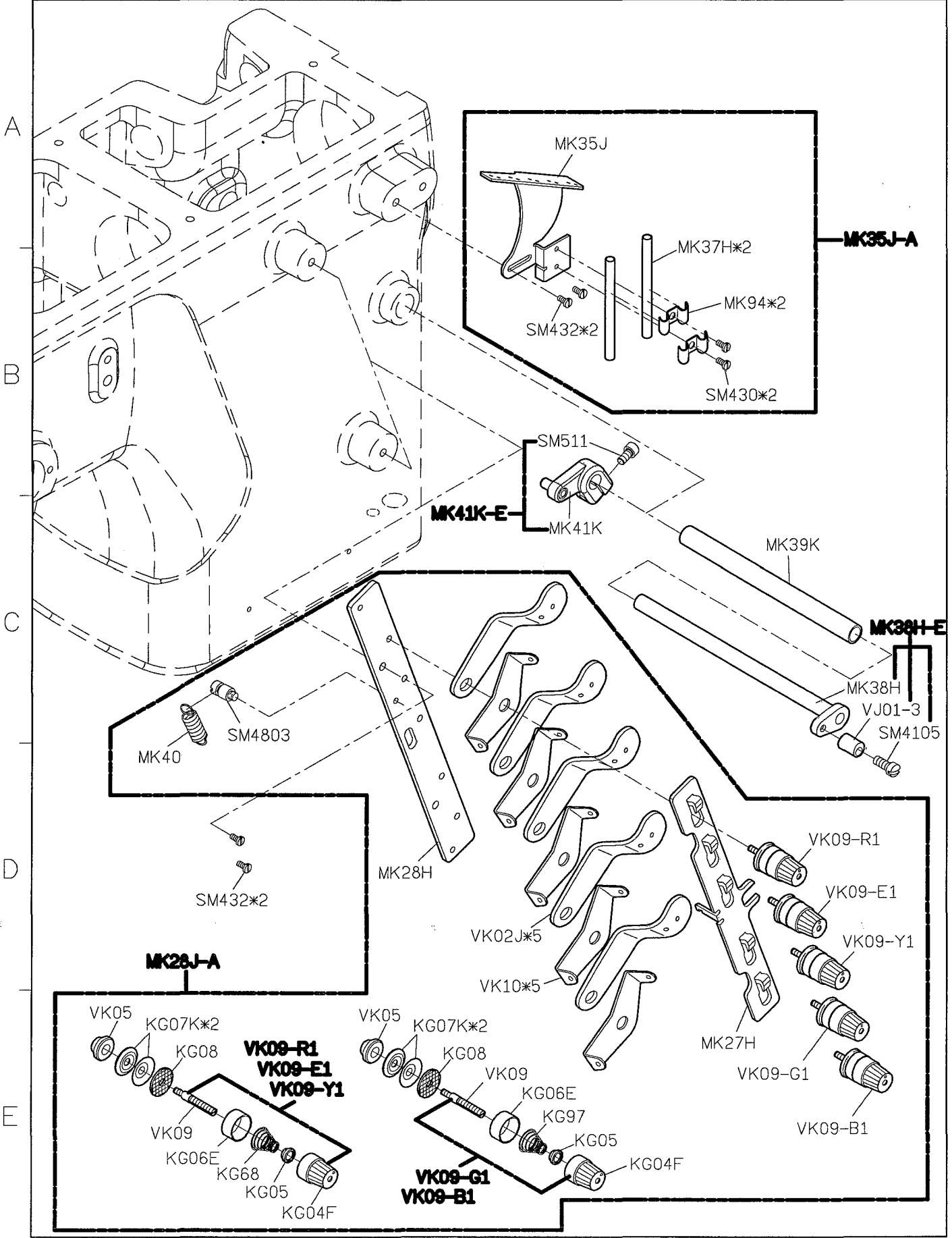



SIRUBA PARTS LIST	Series	Parts Group	Subclass / Remark	Page
	C007K/C007KD	MN-K		1/2
	C858K/C858KD			Date
				2012/11/01

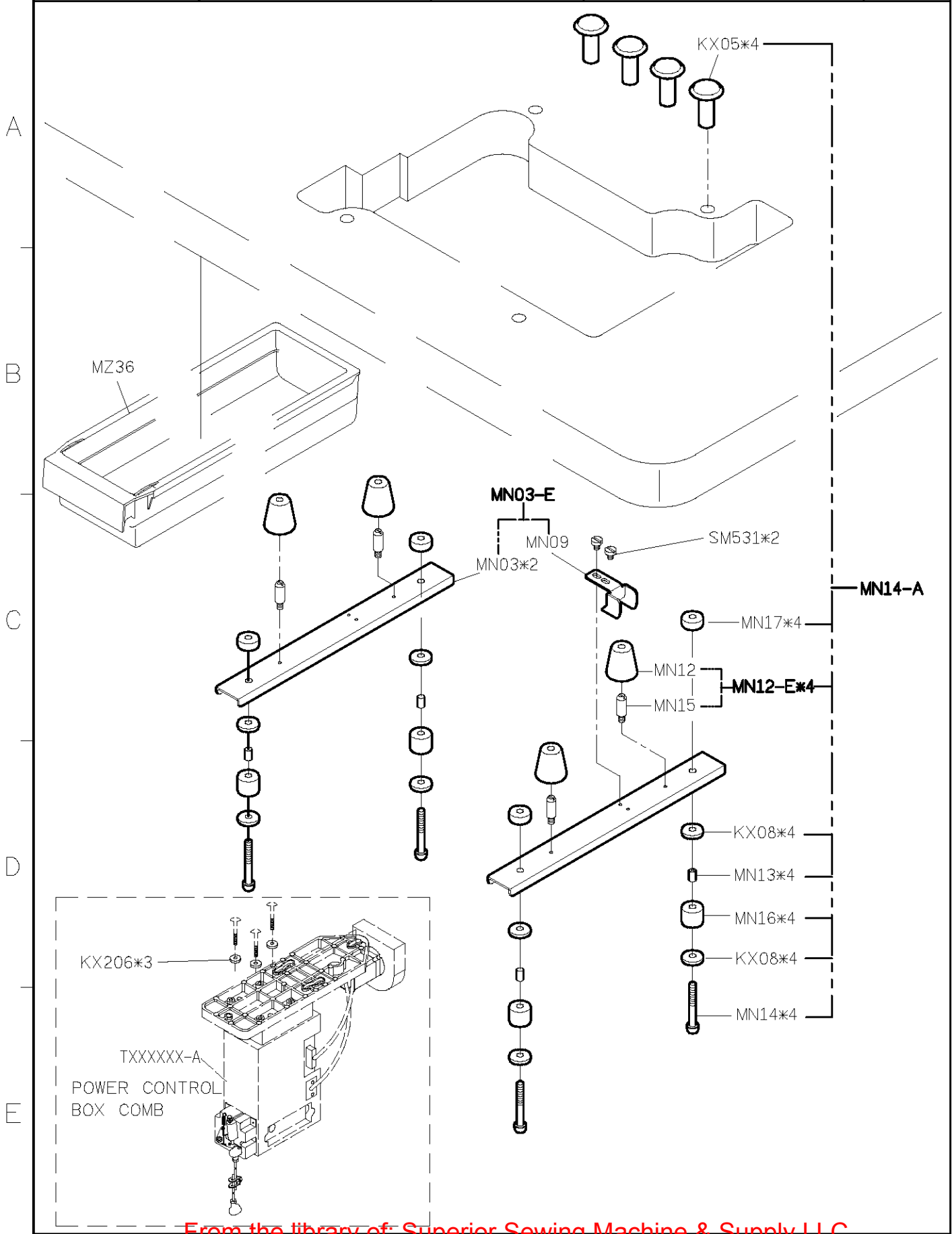

SIRUBA PARTS LIST	Series	Parts Group	Subclass / Remark	Page
	C007K/C007KD	MN-K	#: Use for C007K/C858K	2/2
	C858K/C858KD			Date
	2012/11/01			

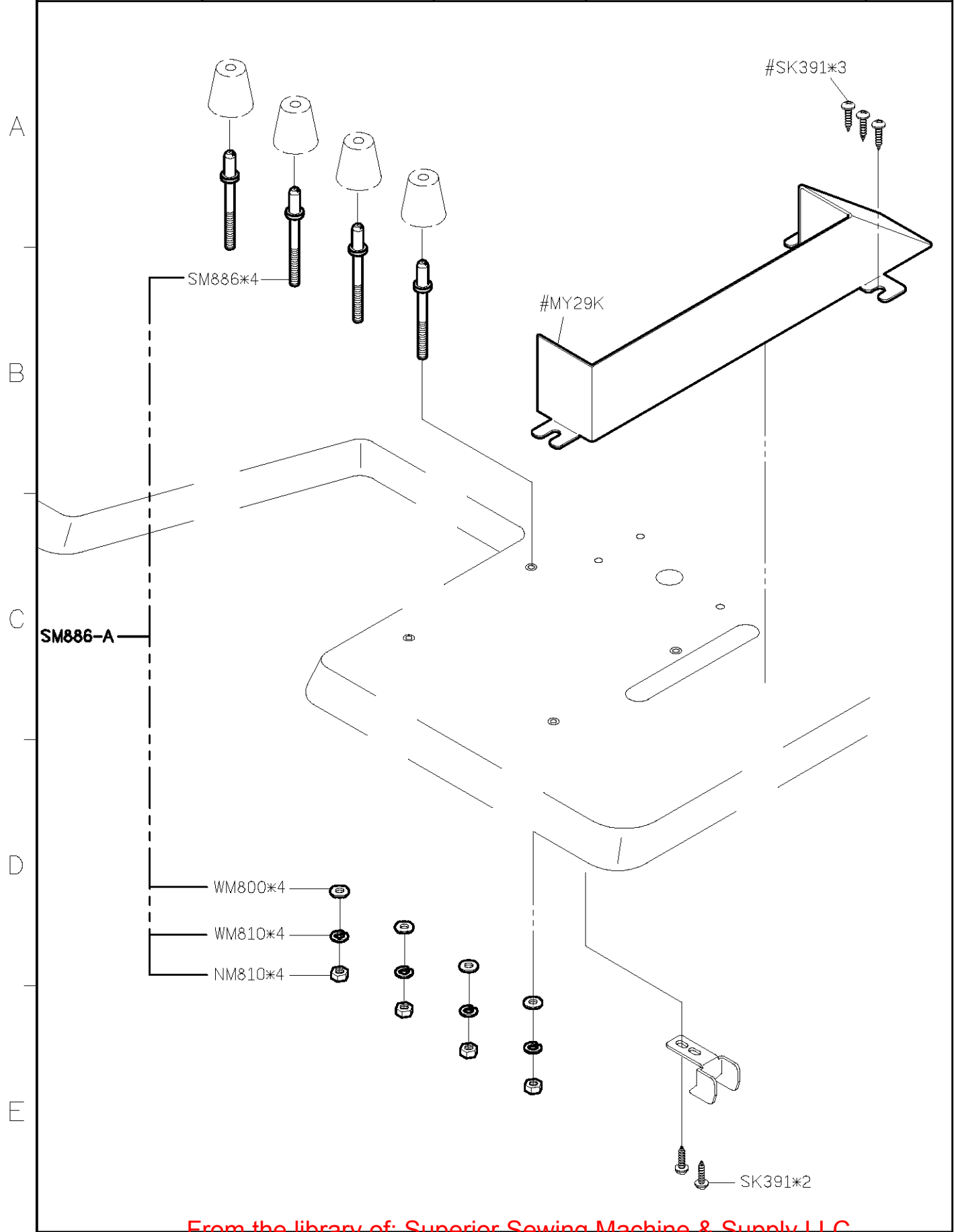

SIRUBA PARTS LIST	Series	Parts Group	Subclass / Remark	Page
	C007K/C007KD C858K/C858KD	MQ-K	[T] : Use for T brand motor [H] : Use for H brand motor # : Use for C007KD/C858KD	1/1 Date 2015/11/27

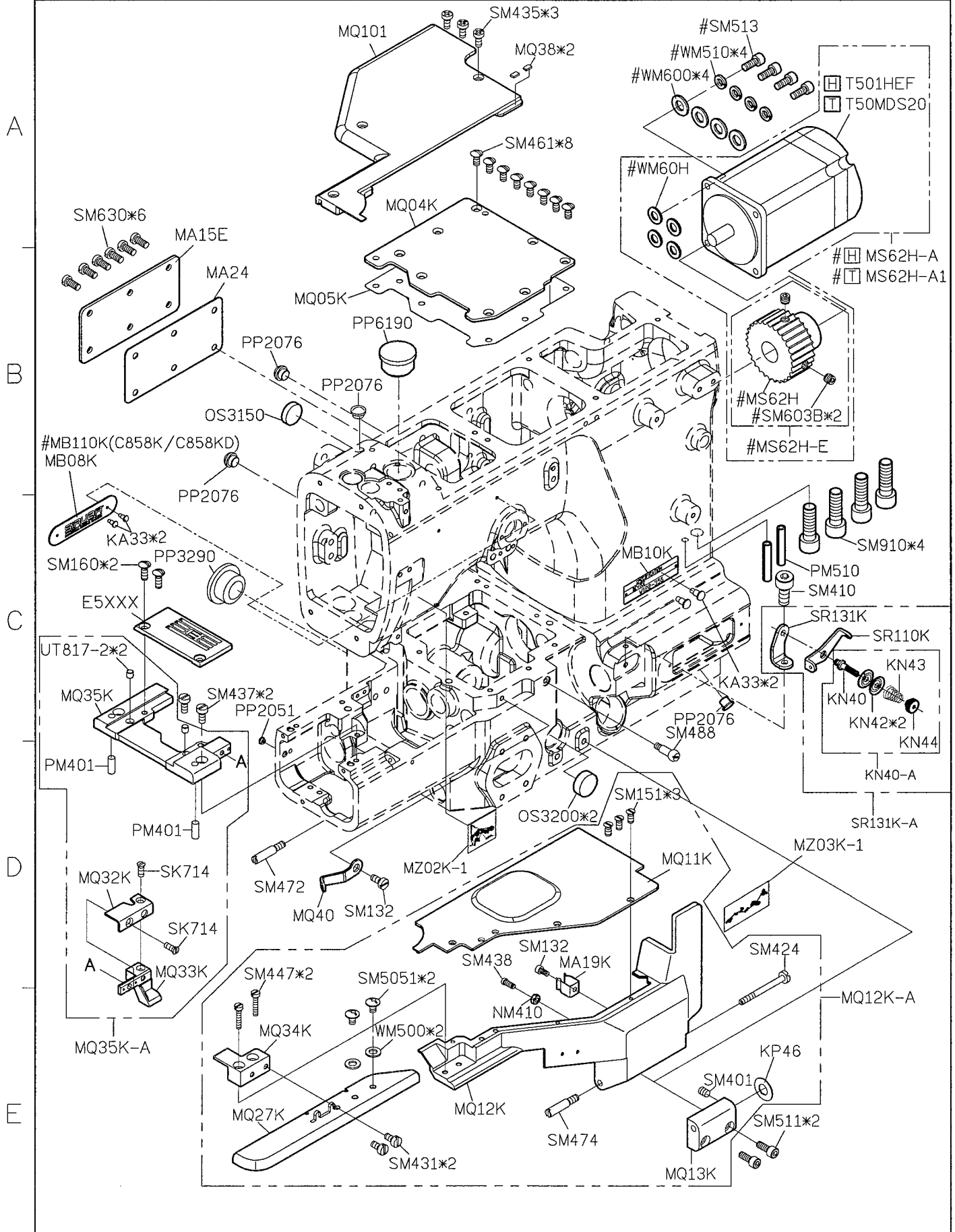

1 2 3 4 5

**SIRUBA**  
**PARTS LIST**

**Series**  
**C007K/C007KD**  
**C858K/C858KD**

**Parts Group**  
**MR-K**

**Subclass / Remark**

# : Use for C007KD/C858KD  
△ : Use for CW  
◎ : Use for UT  
☆ : Use for C858K/C858KD

**Page**

**1/1**

**Date**

**2015/01/19**

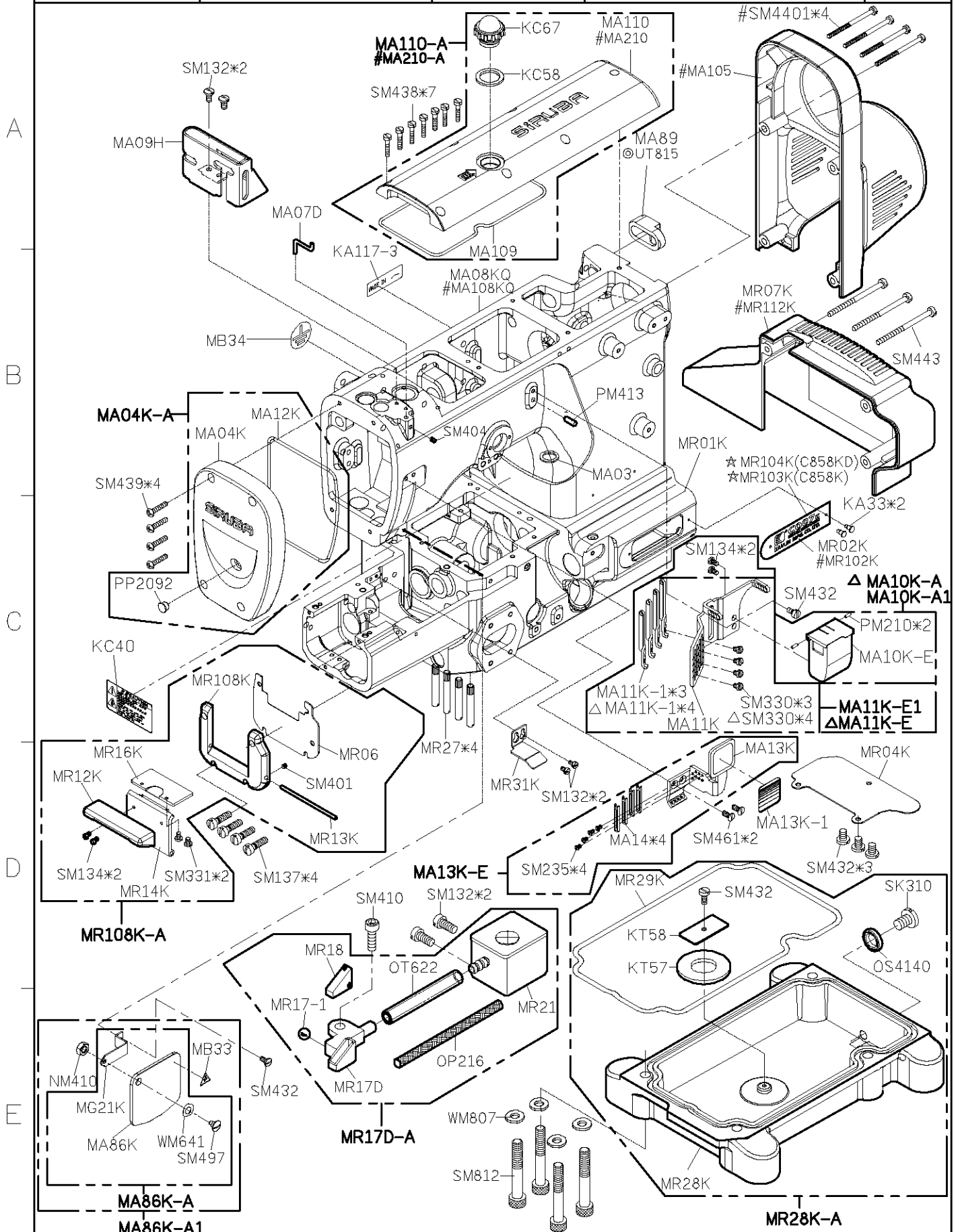

SIRUBA PARTS LIST	Series	Parts Group	Subclass / Remark	Page
	C007K/C007KD	MS-K	# : Use for C007KD/C858KD	1/1
	C858K/C858KD			Date
				2015/10/01

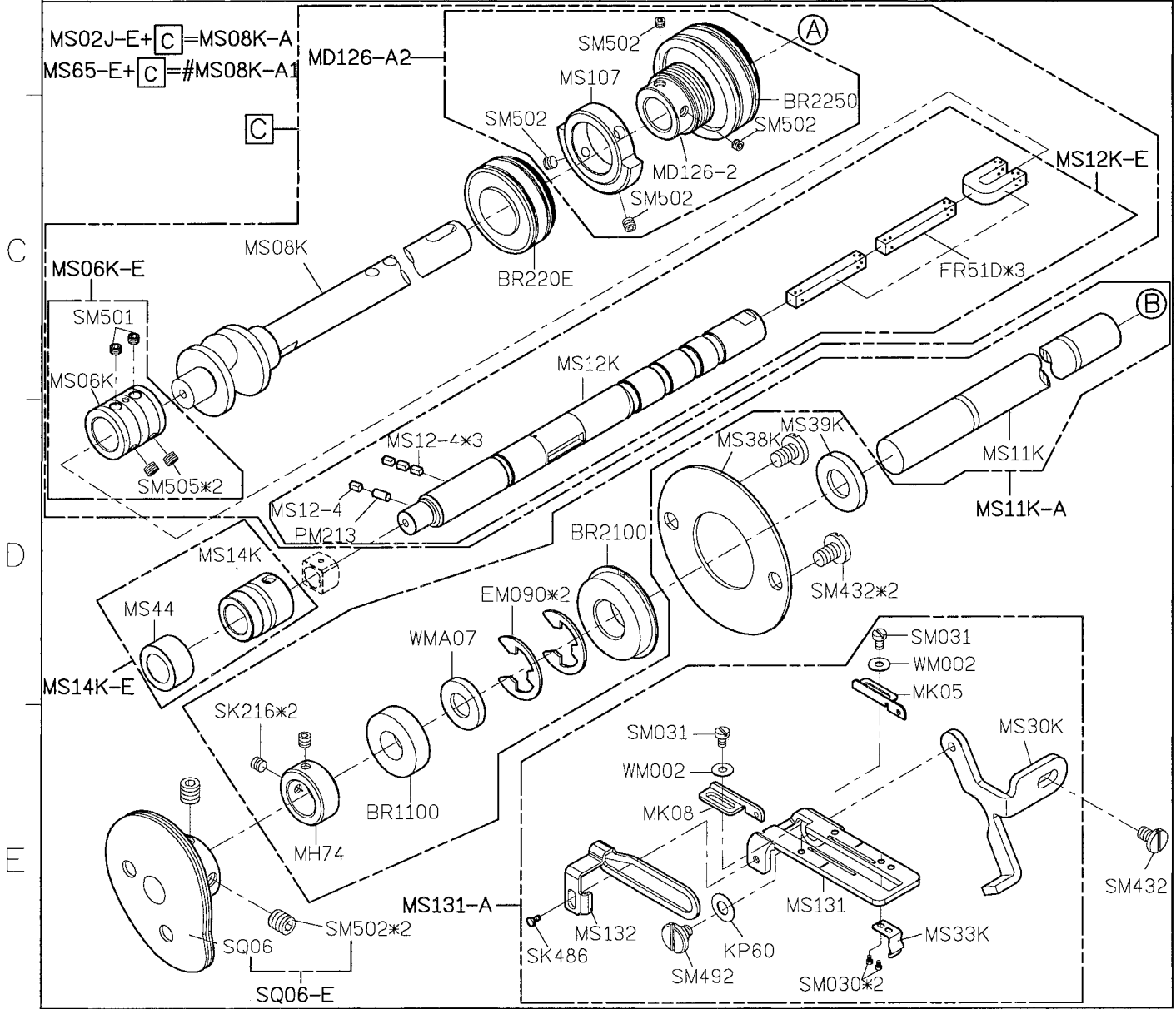
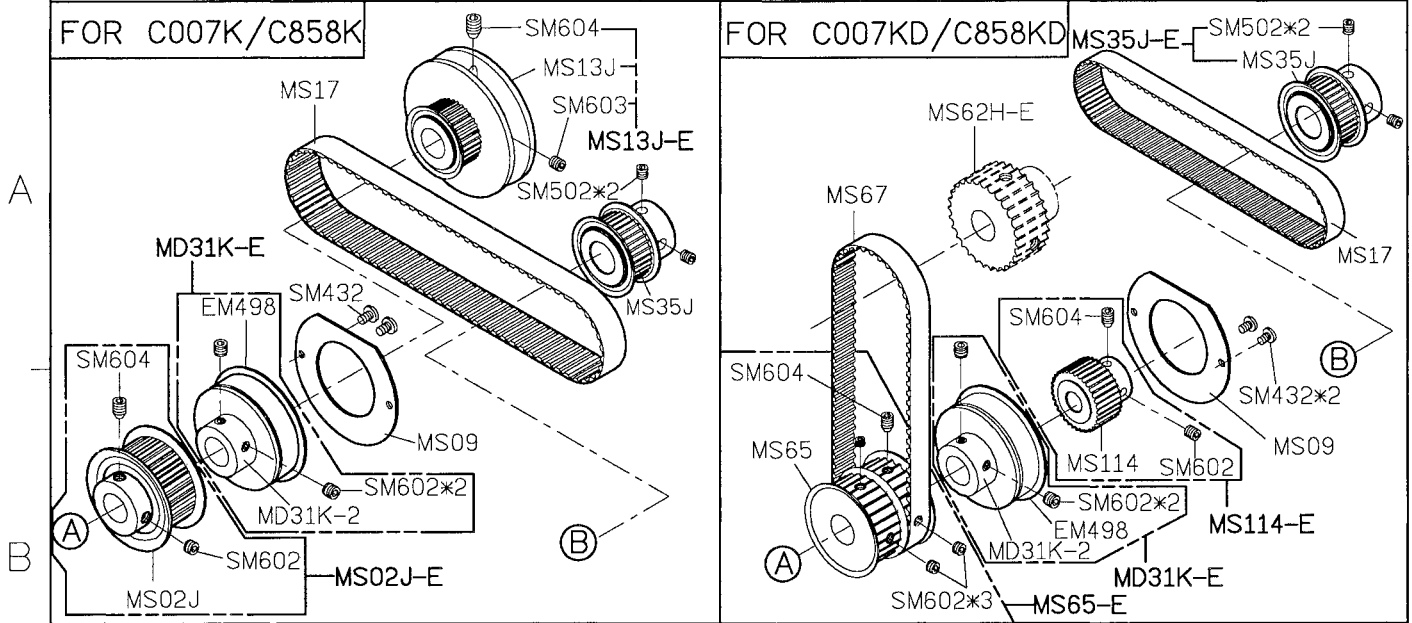



<b>SIRUBA</b> <b>PARTS LIST</b>	<b>Series</b>	<b>Parts Group</b>	<b>Subclass / Remark</b>	<b>Page</b>
	<b>C007K/C007KD</b>	<b>MT-K</b>		<b>1/1</b>
	<b>C858K/C858KD</b>			<b>Date</b>
				<b>2015/01/06</b>

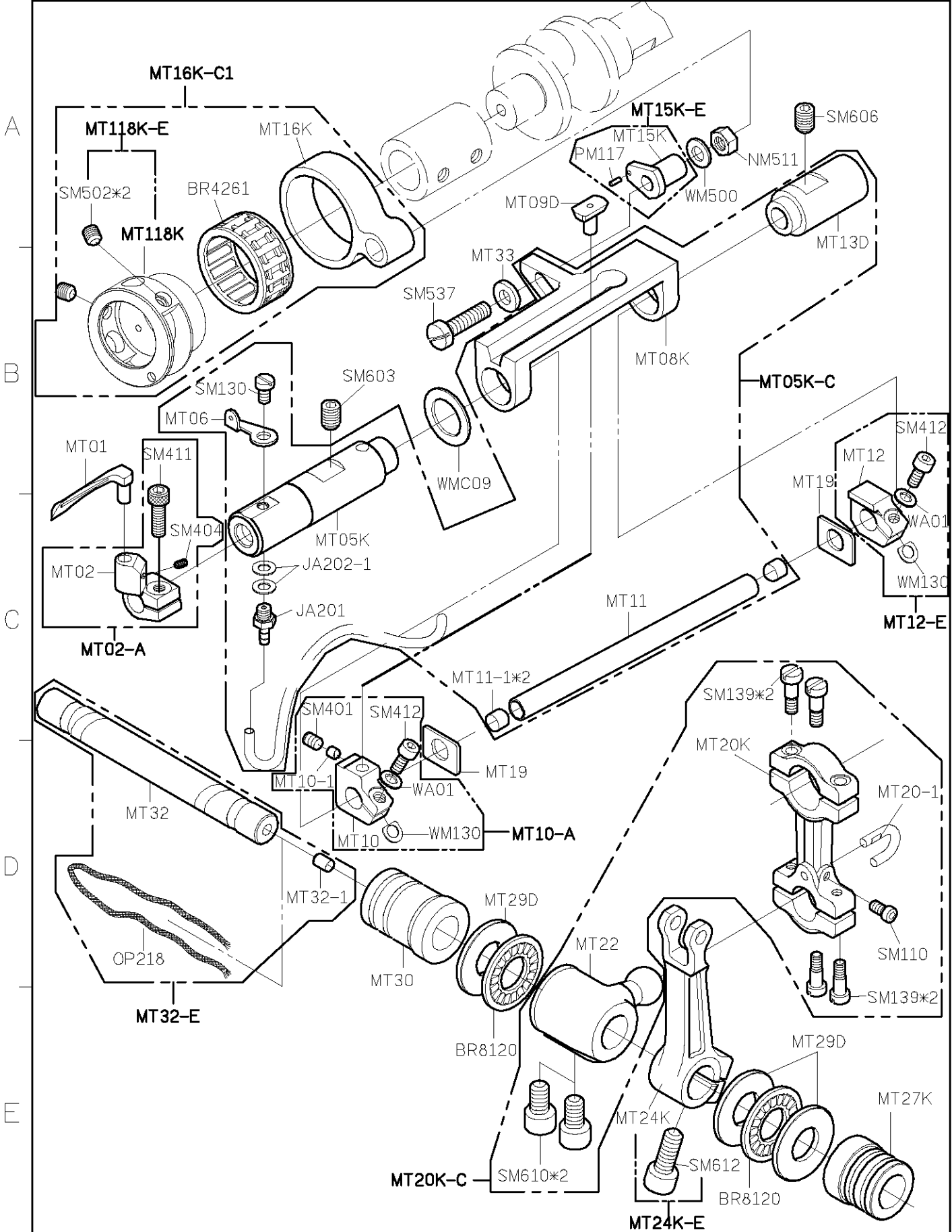

<b>SIRUBA</b> PARTS LIST	Series	Parts Group	Subclass / Remark	Page
	C007K/C007KD C858K/C858KD	<b>MU-K</b>	# : Use for CRL	1/1
				Date
				2015/11/26

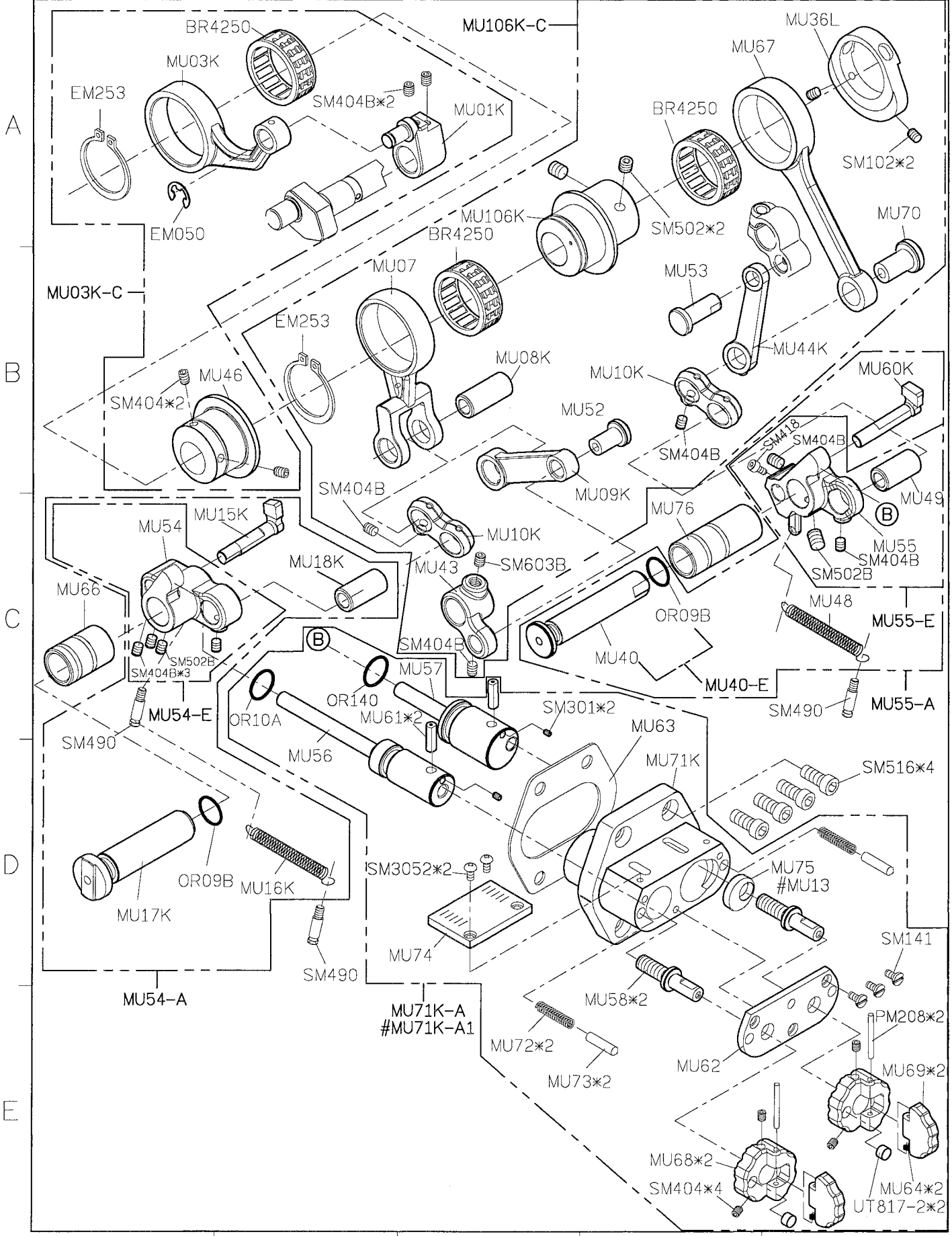





**SIRUBA**

PARTS LIST

Series  
C007K/C007KD  
C858K/C858KD

Parts Group  
**MW-K**

Subclass / Remark

Page

1/1

Date

2016/01/22

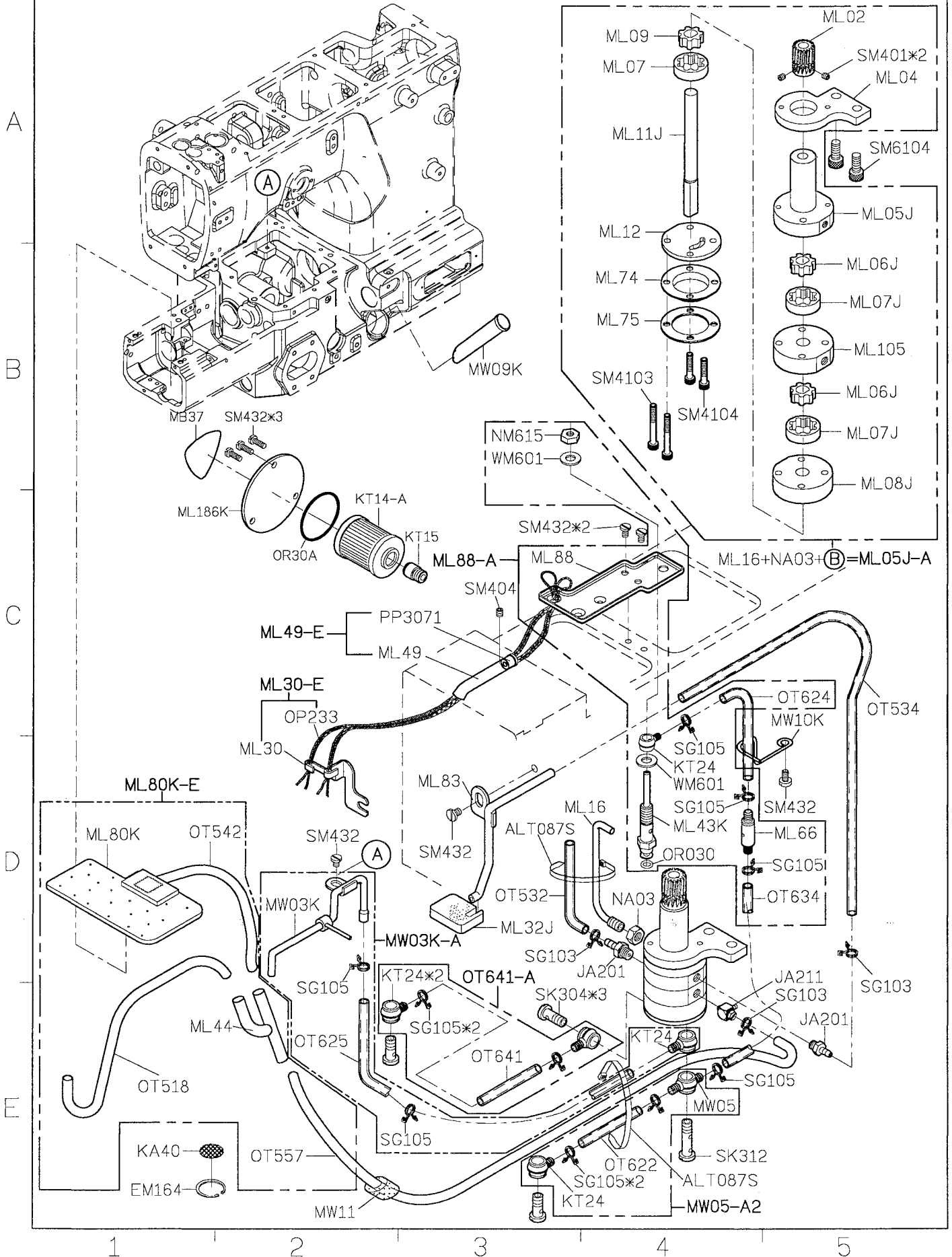

<b>SIRUBA</b> <b>PARTS LIST</b>	<b>Series</b>	<b>Parts Group</b>	<b>Subclass / Remark</b>	<b>Page</b>
	<b>C007K/C007KD</b> <b>C858K/C858KD</b>	<b>MY-K</b>	⊙ : Use for C007K/C858K □ : Use for C007KD/C858KD	1/1
				Date
				2013/10/23

MY01 KY03 KY04 KY05-A KY23-A  
 KY23(6/7mm) KY09

MY10-A  
 MY09 1.5 2 2.5 3 4 5  
 KY10 MY10 MY11 MY12 KY11  
 KY14 LY33-A LY33 LY34 KY18

KY20D-A 針\*5 MY21-E KY21-1 MY21 KY201 KZ03

KT14-A ⊙MY29K ⊙SM886-A □SM886-A1  
 SM886\*4 WM800\*4 SM886\*4 WM800\*4  
 WM810\*4 NM810\*4 WM810\*4 NM810\*4  
 SK391\*2 SK392\*3 SK391\*2

MY127K Instruction book (使用説明書)  
 MY32K Parts list (零件圖)

Parts list	
Basic mechanism	MY32K
Special mechanism	MY32K
UTP/UTQ	MY32K UT120K
Special machine type + UTP/UTQ	MY32K UT120K
UTR/UTS	MY32K UT240K
Special machine type + UTR/UTS	MY32K UT240K

1 2 3 4 5

SIRUBA PARTS LIST	Series	Parts Group	Subclass / Remark	Page
	C007K/C007KD C858K/C858KD	<b>MZ-K</b>	#: Use for C007KD/C858KD	1/1
				Date 2013/03/14

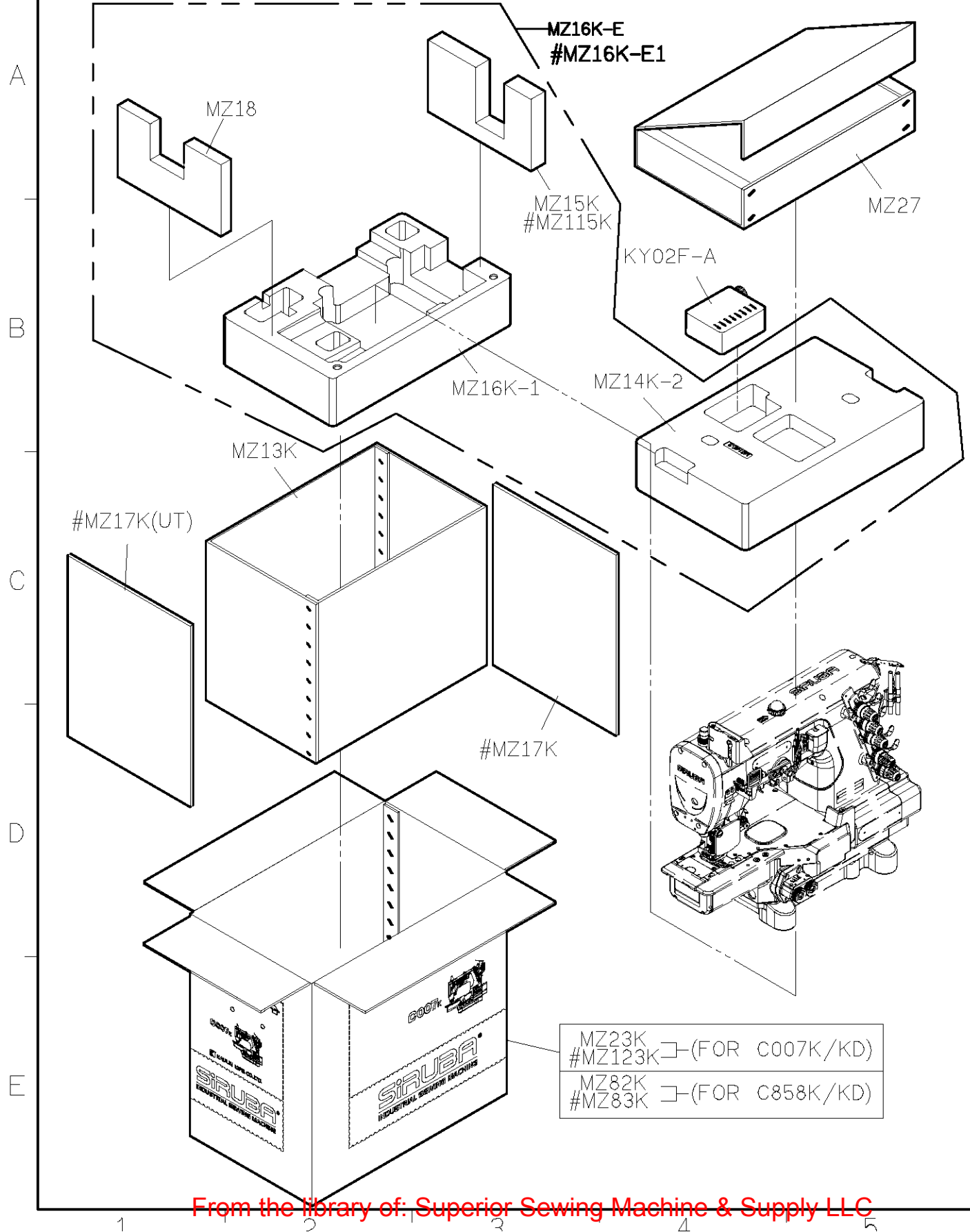



SIRUBA TABLE CUT - OUT	Series	Item Code	Subclass / Remark	Mounting
	C007K/C007KD C858K/C858KD S007K/S007KD	C007K-T25	For All Series excluding ① RLP,RLQ Celastic tape attaching ② CRL Models ③ Condensed stitch(CAR,CMR,SAR,SER...)	Non-submerged
	Date			
				2013/01/26

三針筒車上乘桌板圖  
 C007K/C007KD/C858K/C858KD/S007K/S007KD SERIES TABLE CUT-OUT SEMI-SUBMERGED  
 單位/UNIT:mm  
 FOR CRL,CRL/UTP.Q  
 所有尺寸公差/DIFFERENCE:±2  
 C007K-T25-1070長度(L):1070/重量:11.3kg±5%  
 C007K-T25長度(L):1200/重量:12.3kg±5%  
 全封邊灰格紋光塑面台板

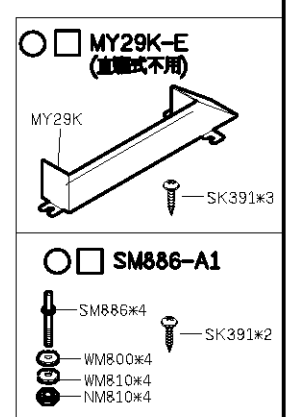
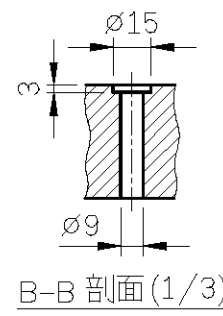
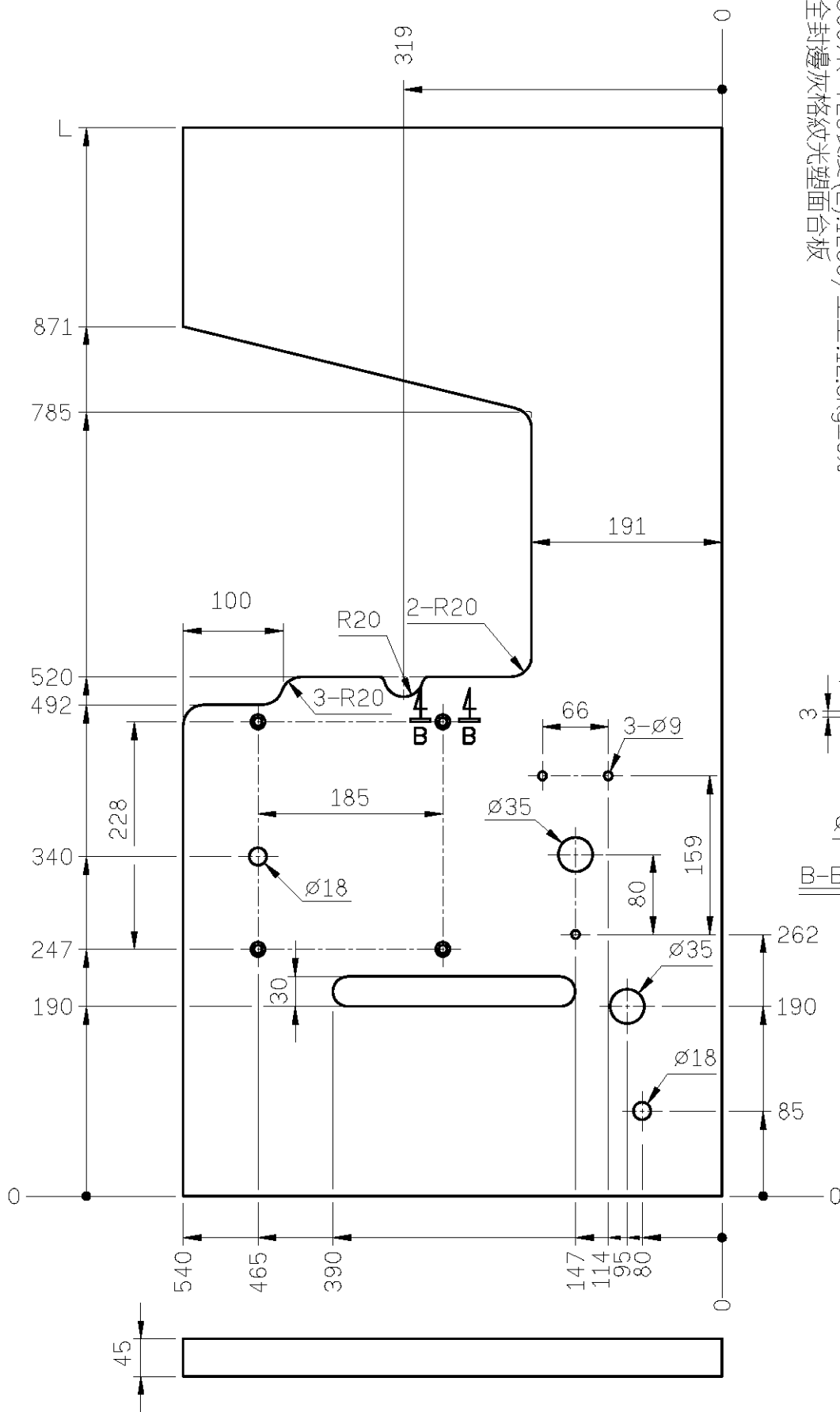

<b>SIRUBA</b> TABLE CUT - OUT	Series	Item Code	Subclass / Remark	Mounting
	C007K/C858K	C007K-T26	For CFC	Semi-submerged
				Date
				2015/11/27

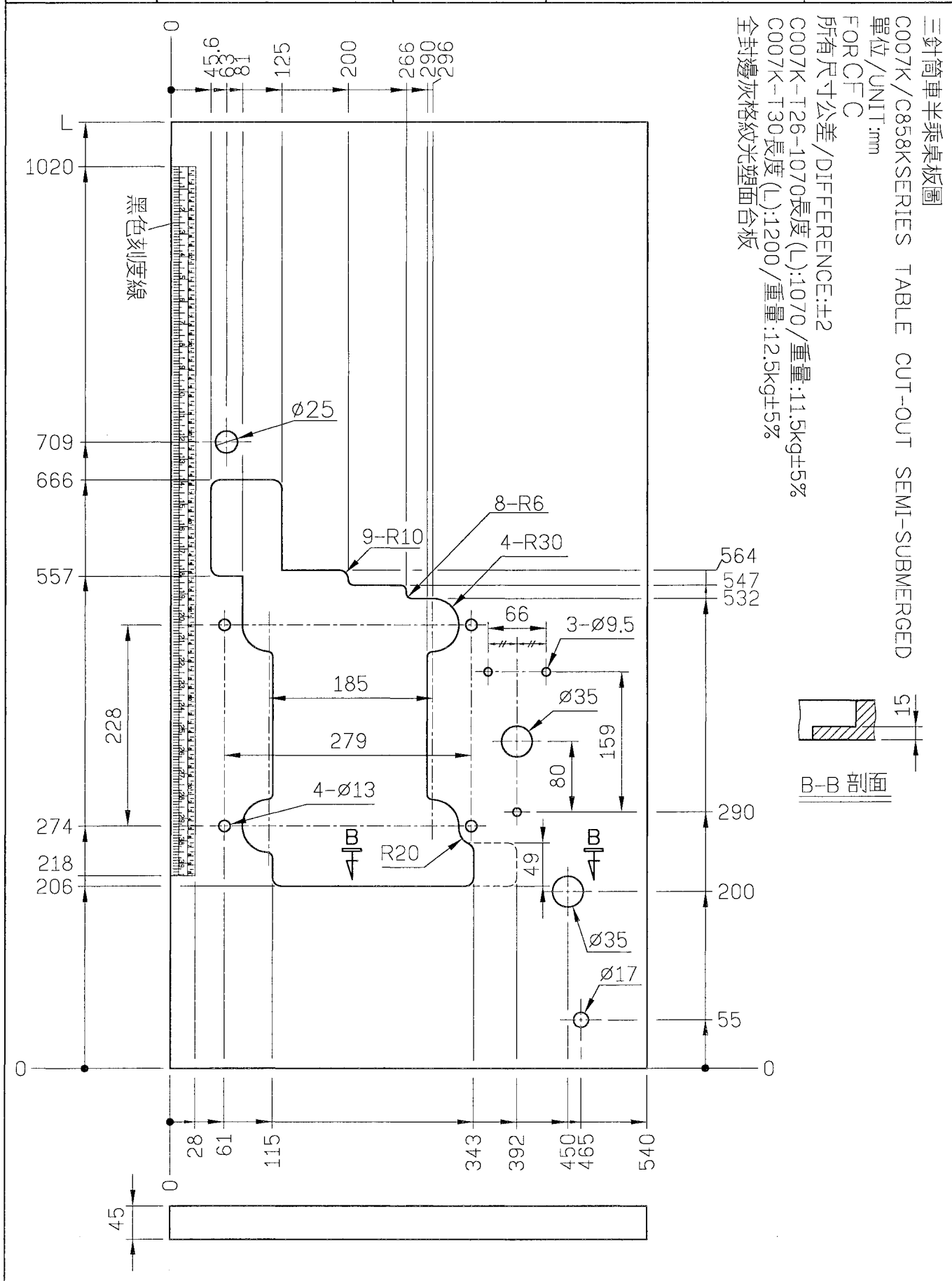

<b>SIRUBA</b> TABLE CUT - OUT	Series	Item Code	Subclass / Remark	Mounting
	C007J/C007K	C007-T30		Non-submerged
				Date
				2015/07/14

三針筒車上乘桌板圖  
 C007J/C007K SERIES TABLE CUT-OUT SEMI-SUBMERGED  
 單位/UNIT :mm  
 FOR 印度客戶使用  
 所有尺寸公差/DIFFERENCE:±2  
 C007-T30-1070長度(L):1070/重量:11.3kg±5%  
 C007-T30長度(L):1200/重量:12.3kg±5%  
 全封邊灰格紋光塑面台板

